



Made in Germany

Go To Pictorial Index
Go To Numerical Index



Innovations that work

Catalog 19 • Prices effective April 1, 2004





Made in Germany

www.wihatools.com

Wiha Tool Programs

| Description | Page |
|-------------------------------|------------|
| Torx Tools | 14-25, 176 |
| TorqueControl Tools | 26-31 |
| Hex Tools | 32-43 |
| Maxiflex Hose System | 44-46 |
| Sledge/Dead Blow Hammers | 47 |
| Nut Drivers | 48-53 |
| Wrenches | 54-61 |
| Screwdrivers | 62-81 |
| SYSTEM 6 | 76-80 |
| Insulated Tools | 81-91 |
| Pliers & Cutters | 87-109 |
| Rulers | 102 |
| Precision Tools | 110-129 |
| SYSTEM 4 | 122-129 |
| Tweezers/Hooks/Probes/Mirrors | 130-146 |
| Bits & Bit Sets | 147-165 |
| Bit Holders, Sockets & Sets | 166-169 |

Wiha Main Product Index

| Description | Page |
|----------------------------------|-----------------|
| Slotted Tools Index | 7 |
| Phillips Tools Index | 7 |
| Torx Tools Index | 8, 14, 176, 177 |
| Tamper Resistant Torx Index | 8, 14 |
| TorxPlus Index | 8, 14 |
| Tamper Resistant Hex Index | 8, 32 |
| Hex Index | 9, 32 |
| Ball End Hex Index | 9, 32 |
| MagicRing Index | 9, 32 |
| Nut Drivers Index | 9, 48 |
| Pozidriv Index | 9 |
| Square Index | 10 |
| Wrenches Index | 10, 48 |
| TorqueControl Index | 10, 26 |
| Bit Holders Index | 10, 147 |
| Bit Sets Index | 10, 147 |
| Miscellaneous Tools Index | 11 |
| High Performance Bits Index | 11, 147 |
| Standard Bits Index | 11, 147 |
| Specialty Bits Index | 11, 147 |
| Sockets Index | 12, 147 |
| Tweezers Index | 12, 130 |
| Insulated Pliers/Cutters Index | 12, 81, 87 |
| ComfortGrip Pliers/Cutters Index | 13, 87 |
| Vinyl Grip Pliers/Cutters Index | 13, 87 |
| ESD Safe Pliers/Cutters Index | 13, 87, 103 |
| ESD Safe Tools Index | 13, 103 |

Numerical Index By Item Number 170-175



Made in Germany

Toll Free: (800) 494-6104

NEW

Vinyl Grip Pliers & Cutters



| | |
|------------------|-----|
| Combination | 96 |
| Stripping Pliers | 96 |
| Long Nose | 97 |
| Adjustable | 98 |
| Cutters | 99 |
| Nippers | 100 |
| Retaining Ring | 101 |

ComfortGrip Pliers & Cutters



| | |
|------------------|----|
| Combination | 92 |
| Stripping Pliers | 92 |
| Long Nose | 93 |
| Adjustable | 94 |
| Cutters | 95 |

Insulated Pliers & Cutters



| | |
|-------------|----|
| Combination | 88 |
| Cutters | 89 |
| Long Nose | 91 |

Wrenches



| | |
|----------------------|-------|
| Open End Inch/Metric | 54-55 |
|----------------------|-------|



| | |
|-----------------------|----|
| Soft Grip Inch/Metric | 56 |
|-----------------------|----|



| | |
|-------------------------|-------|
| Combination Inch/Metric | 57-60 |
|-------------------------|-------|



| | |
|--------------------------|----|
| Box Wrenches Inch/Metric | 61 |
|--------------------------|----|

Rulers



| | |
|--------------------|-----|
| Inch/Metric Rulers | 102 |
|--------------------|-----|

Maxiflex Hose System



| | |
|---------------|----|
| Maxiflex 1/4" | 45 |
| Maxiflex 1/2" | 46 |

X-Selectors Bit Sets



| | |
|----------------|-----|
| Slot/Phil/Torx | 148 |
| Torx | 148 |
| TR Torx | 148 |
| Hex Inch | 148 |

TorqueControl Tools



| | |
|---------------|-------|
| TorqueVario-S | 26-29 |
|---------------|-------|



| | |
|-------------------------|----|
| Insulated TorqueVario-S | 30 |
|-------------------------|----|



| | |
|------------------------|----|
| ESD Safe TorqueVario-S | 31 |
|------------------------|----|

ESD Safe SoftFinish Drivers



| | |
|-----------------------|----|
| Slotted/Phillips/Torx | 68 |
|-----------------------|----|

Orbit Pivot Drivers



| | |
|----------|----|
| Phillips | 63 |
|----------|----|



ClicFix Quick Release Holder



| | |
|------------------------------|-----|
| ClicFix Quick Release Holder | 153 |
|------------------------------|-----|



Made in Germany

www.wihatools.com

Correct ordering:

Prompt Delivery!

The Wiha catalog comprises of 176 pages with over 2850 Items. On these pages you will find important information you need to know to use and order our products correctly and easily.

Ordering:

Each Item shows an appropriate part number in the list. The bold number in the grey box under **Item no.** is the correct number to use when ordering a product.

The catalog offers three different ways to look up item numbers:

1. On pages 5-6 you will find a numerical index by series. Example: Series 520, MicroFinish Slotted Screwdrivers, can be found on page 69.
2. On pages 7-13 you will find products by the tip style. Example: From page 9, Hex Insert Bits can be found on page 163.
3. On pages 170-175 you will find items in a numerical order index.
4. On page 2 table of contents for programs and index

Warranty

Wiha warranty states all product shall be free from defects in materials and workmanship upon delivery. Should a product be received that is defective or incomplete, Wiha is only obligated to replace the product, excluding all further warranty. Defective products must be reported and returned immediately upon receipt. Bits, ceramic tools & tweezers are not covered by replacement warranty under any circumstances. Products may be returned to place of purchase or directly to Wiha for replacement.

Wiha is not liable for the following:

any goods which have been repaired or altered in any way; any goods which have been subject to any accident or damage or which have been maintained, stored or used improperly; any direct consequential loss or damage of anything whatsoever (including without limitation loss of profits revenue or contracts) or for any damage to or destruction of any property; injury to or death of any person except to the extent that such injury or death is caused by negligence on the part of Wiha or its employees; unsuited, inappropriate and faulty application and treatment; normal wear and tear due to use.

Hand Tool Safety

Always wear proper eye and hand protection when using tools. Always use the proper tool, screwdrivers are not designed for prying, chiseling or scraping. Screwdriver tips should be in good condition and closely fit fastener. Inspect tools periodically and discard worn or damaged items.

® **TORX**® & TORXPlus are registered trademarks of Camcar/Textron.
® Pozidriv is a registered trademark of Phillips Screw Company.

520 Slotted screwdriver, with Wiha MicroFinish handle. Blade high alloy chrome-vanadium-molybdenum steel, hardened, chrome-plated. Wiha MicroFinish handle, cellulose-acetate, impact resistant, non-slip, oil & grease resistant. Exact fit precision ground tip, Wiha chromtop.

| Item No. | Size | Inch | mm | Inch | mm | Inch | mm | Inch | lbs. | pcs. |
|---------------|------|------|-----|------|-----|------|-----|------|------|------|
| 520 05 | 4.0 | 5/32 | 100 | 4.0 | 0.8 | .031 | 211 | 8.3 | .16 | 10 |

| Item Number | Tip dimension in MM & tip symbol | Tip dimension in Inches | Length of blade in MM | Length of blade in Inches | Tip width in MM | Tip width in Inches | Total length in MM | Total length in Inches | Weight | Packaging units Minimum quantity |
|-------------|----------------------------------|-------------------------|-----------------------|---------------------------|-----------------|---------------------|--------------------|------------------------|--------|----------------------------------|
| 520 05 | 4.0 | 5/32 | 100 | 3.94 | 0.8 | 0.031 | 211 | 8.31 | 0.16 | 10 |

Article Information

- Slotted
- Phillips
- Torx
- Tamper Resistant Torx
- Hex/Ball End/MagicRing
- Tamper Resistant Hex
- Nut Driver
- Pozidriv
- Square
- Triwing
- Spanner
- Torq Set
- TorxPlus

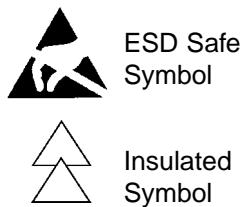

How to compose a bar code
084705 + ordering number +
check digit





Made in Germany

Toll Free: (800) 494-6104

Click on page number to view product

Numerical Index by Series

| Series | Description | Page | Series | Description | Page | Series | Description | Page |
|--------|---|----------|--------|--------------------------------------|---------|--------|--|------------|
| 100 | SYSTEM 6 Slotted Blades/Sets | 77-78 | 287 | Insulated TorqueControl Blades | 30 | 365 | TorxPlus Wing Handle/Set | 25 |
| 101 | SYSTEM 6 Phillips Blades/Sets | 77,79 | 288 | ESD Safe TorqueControl Blades/Set | 31 | 365 | Wing Torx & Set & Screw Holding | 22, 177 |
| 102 | SYSTEM 6 Pozidriv Blades | 77 | 300 | Square Reamer | 80 | 366 | TorxPlus Long Arm L-keys | 25 |
| 103 | SYSTEM 6 Hex Inch Blades | 77 | 301 | Round Scratch Awls | 80 | 367 | MagicRing SoftFinish Screwdrivers | 39-40 |
| 104 | SYSTEM 6 Hex Metric Blades | 77 | 302 | SoftFinish Mechanics Slotted & Sets | 66 | 369 | MagicRing PocketStars | 40 |
| 105 | SYSTEM 6 Inch Nut driver Blades | 77 | 302 | ESD Safe SoftFinish Screwdrivers | 68 | 369 | Ball End Hex Keys & Sets | 34-35 |
| 106 | SYSTEM 6 Metric Nut driver Blades/Sets | 77,79 | 304 | SoftFinish Stubby Slotted | 66 | 370 | Flag Torx & Set | 22 |
| 107 | SYSTEM 6 Torx Blades/Sets | 19,77,79 | 308 | SoftFinish Heavy Duty Slotted & Sets | 65 | 380 | Multi Bit Holders and Sets | 85,149,154 |
| 108 | SYSTEM 6 Handles | 76 | 311 | Phillips Orbit Pivot Drivers | 63 | 384 | SoftFinish Magnetic Bit Holder | 67,154 |
| 109 | SYSTEM 6 Adapter Blades/Sets | 78-79 | 311 | SoftFinish Phillips & Set | 66 | 388 | T-Handle Bit Holders | 154 |
| 109 | SYSTEM 6 Extension Blades | 78 | 311 | SoftFinish Stubby Phillips | 66 | 394 | Screwholding Slotted Drivers | 74 |
| 111 | SYSTEM 6 TR Torx Blades/Sets | 19,77,79 | 312 | SoftFinish Heavy Duty Phillips & Set | 65 | 395 | Screwholding Phillips Drivers | 74 |
| 153 | Square Handle Phillips | 74 | 313 | SoftFinish Pozidriv | 67 | 400 | Combination Wrenches Inch/Metric | 57-60 |
| 161 | Offset Phillips Screwdrivers | 74 | 320 | Insulated Slotted & Sets | 82-83 | 400 | Magnetizer/Demagnetizer | 75 |
| 186 | Square Handle Cabinet Tip Slotted | 74 | 321 | Insulated Phillips & Sets | 82-83 | 430 | Universal Razor Shaver & Blades | 67 |
| 207 | Offset Slotted Screwdrivers | 74 | 322 | Insulated Nut Drivers/Sets | 53,84 | 445 | SYSTEM 4 Technicians Blade Kit | 124 |
| 222 | Pozidriv Square handle | 74 | 325 | Insulated Torx & Sets | 85 | 455 | 3K Ergo Torx Screwdrivers & Sets | 18 |
| 260 | Precision Tool Stands & Clips | 117 | 326 | Wiha Pliers & Cutters | 87-101 | 455 | Protorn Torx Drivers & Sets | 17 |
| 260 | Precision Slotted & Sets | 113-114 | 326 | Insulated Retaining Ring Bit Holder | 154 | 460 | 3K Ergo Slotted Screwdrivers | 72 |
| 261 | Precision Phillips & Sets | 113-114 | 327 | ESD Safe Pliers | 104-109 | 460 | 3k Ergo Slotted & Phillips Sets | 73 |
| 262 | Precision Pozidriv Drivers | 115 | 328 | Insulated Pliers/Cutters/Drivers Set | 85-86 | 461 | 3K Ergo Phillips Screwdrivers | 72 |
| 263 | Precision Hex Drivers & Sets | 114 | 328 | Insulated Pliers & Cutters | 88-91 | 467 | 3k Ergo Ball End Hex Drivers & Sets | 41 |
| 264 | Precision Ballpoint & Sets | 115 | 329 | ComfortGrip Combination Pliers | 92-95 | 468 | ACO Phillips Screwdrivers | 71 |
| 265 | Precision Nut Drivers & Sets | 116 | 334 | Comfort Grip Hex Inch T-handles | 37 | 469 | ACO Slotted Screwdrivers | 71 |
| 267 | Precision & Screw Holding Torx | 117, 176 | 334 | Comfort Grip Hex Inch Sets | 37 | 475 | Box Wrenches Inch & Metric | 61 |
| 268 | Precision Lifter | 117 | 334 | Comfort Grip Hex Metric T-handles | 37 | 481 | SYSTEM 6 Mag/Demag Handle | 76 |
| 269 | SYSTEM 4 Handles/Blades | 122-123 | 334 | Comfort Grip Hex Metric Set | 37 | 481 | SYSTEM 6 Mag/Demag Blade Set | 77 |
| 269 | SYSTEM 4 Sets/Canvas Pouch | 124 | 334 | T-Handle Hex & Sets | 38 | 484 | Protorn Bit Holder & Torx Bit-Selector | 17,154 |
| 269 | SYSTEM 4 Sets/Fold Out Box | 126 | 336 | T-Handle Nut drivers & Sets | 52 | 484 | 3K Series Bit Holder | 73,154 |
| 269 | SYSTEM 4 Sets/Steel Box | 125 | 339 | T-Handle Socket Drivers | 52,167 | 500 | SoftGrip Wrenches Inch/Metric | 56 |
| 270 | Precision Ceramic Slotted & Set | 112 | 340 | Maxiflex Hose System 1/2" | 46 | 510 | Dynamic Slotted Drivers & Set | 75 |
| 271 | Precision Ceramic Phillips & Set | 112 | 341 | SoftFinish Nut Drivers & Sets | 49 | 511 | Dynamic Phillips Drivers & Set | 75 |
| 272 | Precision ESD Safe Slotted Driver | 110 | 343 | SoftFinish Hollow Shaft Nut Drivers | 51 | 520 | MicroFinish Slotted Drivers & Set | 69 |
| 273 | Precision ESD Safe Phillips & Set | 110-111 | 344 | Maxiflex Hose System 1/4" | 45 | 521 | MicroFinish Phillips Drivers & Set | 69 |
| 275 | Precision ESD Safe Hex Metric | 112 | 347 | SoftFinish Nut Drivers & Sets | 50 | 526 | MicroFinish Bit Holder | 69,154 |
| 277 | Prec ESD Safe Nut Driver Metric | 112 | 350 | Open End Wrenches Inch & Metric | 54-56 | 527 | MicroFinish Torx Drivers & Set | 16 |
| 278 | Precision ESD Safe Torx Driver/Set | 111 | 351 | L-Wrench Hex Keys & Sets | 43 | 530 | SoftFinish Heavy Duty Slotted & Set | 64 |
| 279 | Precision Anti-Static Lifter | 117 | 352 | Hex L-keys Nickel-Plated Long Arm | 42 | 531 | SoftFinish Heavy Duty Phillips & Set | 64 |
| 280 | SYSTEM 4 Anti-Static Handles | 122 | 352 | Hex L-Key Sets Nickel-Plated | 42 | 533 | MicroFinish Heavy Duty Slotted & Sets | 70 |
| 280 | SYSTEM 4 Ballpoint Blades | 123 | 352 | Hex L-keys Black Finish Long Arm | 42 | 534 | MicroFinish Heavy Duty Phillips & Set | 70 |
| 280 | SYSTEM 4 Pouch Sets | 124 | 352 | Hex L-Key Sets Black Finish | 42 | 540 | MagicRing T-handles & Sets | 36 |
| 280 | SYSTEM 4 Anti-Static Sets | 125 | 353 | Hex Black L-keys - Short Arm | 43 | 616 | Maxiflex Folding Rulers | 102 |
| 281 | SYSTEM 6 SoftFinish Handle | 76 | 353 | Hex Black L-key Sets | 43 | 668 | Precision Bit Holder | 119,154 |
| 281 | SYSTEM 6 T-Handle | 76 | 358 | SoftFinish Square Driver | 67 | 629 | SYSTEM 4 Protorn Blade Sets | 120 |
| 282 | SYSTEM 6 Topra Handle | 76 | 361 | TorxPlus L-keys | 25 | 669 | MagicRing Ball End Metric Hex L-key | 33 |
| 282 | SYSTEM 6 Topra Blade Sets | 80 | 362 | ESD Safe SoftFinish Torx Drivers | 16,68 | 669 | MagicRing Ball End Inch Hex L-key | 33 |
| 282 | SYSTEM 6 Topra Ratchet Bit Sets | 19 | 362 | Powerhandle Torx Drivers & Sets | 16 | 669 | MagicRing Ball End L-Key Sets | 33 |
| 284 | SYSTEM 6 Long Blades | 78 | 362 | TorxPlus SoftFinish Screwdriver | 24 | 701 | Tamper Resistant Torx 1/4" Bits | 161 |
| 285 | TorqueControl Handles | 27 | 362 | Soft Grip Torx & Screw Holding Torx | 15, 176 | 701 | Tamper Resistant Torx Carded Bits | 162 |
| 285 | Torque Blades Slotted/Phillips/Hex/Torx | 29 | 363 | Tamper Resistant Torx L-keys & Sets | 23 | 701 | Tamper Resistant Sockets & Sets | 167-169 |
| 285 | TorqueControl Adapters | 28 | 363 | L-Wrench Torx Keys & Sets | 22-23 | 704 | Nut Setters Inch and Metric | 166 |
| 285 | TorqueControl Sets | 28 | 363 | PocketStars Torx/TR Torx | 21 | 705 | Tamper Resistant Torx Power Bits | 161 |
| 285 | Insulated TorqueControl Handle | 30 | 364 | Comfort Grip Torx T-handles & Set | 20 | 710 | Slotted/Phillips/Hex Bit-Selector | 151 |
| 285 | ESD Safe TorqueControl Handle | 31 | 364 | T-Handle TorxPlus & Set | 24 | 710 | Dura Insert Bit-Selector | 152 |
| | | | 364 | T-Handle Torx & Sets | 20-21 | 710 | Dura Insert Bits Slotted | 155 |



Made in Germany

Toll Free: (800) 494-6104

Click on page number to view product

Slotted Index

| | <u>DESCRIPTION</u> | <u>Page</u> |
|--|---|-------------|
| | SoftFinish® Cushion Grip | 64-66 |
| | ESD Safe SoftFinish Cushion Grip | 68 |
| | MicroFinish Non-Slip Grip | 69-70 |
| | 3K Series | 72-73 |
| | Anti Cam-Out | 71 |
| | Insulated Cushion Grip | 82-83 |
| | Square Handle Cabinet Tip | 74 |
| | Stubby SoftFinish | 66 |
| | Screwholding | 74 |
| | Dynamic | 75 |
| | SYSTEM 6 Blades | 77-78 |
| | Offsets | 74 |
| | Insert Bits Dura, Diamond & Standard | 155,157 |
| | Power Bits | 157 |
| | ESD Safe Precision | 111 |
| | Ceramic Precision | 112 |
| | Precision | 113-114,121 |
| | Protturn Precision | 118 |
| | SYSTEM 4 Blades | 122 |
| | SYSTEM 4 Micro Bits | 127 |

Phillips Index

| | <u>DESCRIPTION</u> | <u>Page</u> |
|--|--|--------------------|
| | Orbit Pivot Driver | 63 |
| | SoftFinish® Cushion Grip | 64-66 |
| | ESD Safe SoftFinish Cushion Grip | 68 |
| | MicroFinish Non-Slip Grip | 69-70 |
| | 3K Series | 72-73 |
| | Anti Cam-Out | 71 |
| | Insulated Cushion Grip | 82-83 |
| | Square Handle | 74 |
| | Stubby SoftFinish | 66 |
| | Screwholding | 74 |
| | Dynamic | 75 |
| | SYSTEM 6 Blades | 77-78 |
| | Offsets | 74 |
| | Insert Bits Dura, Diamond, TiN & Standard | 155-156 158-159 |
| | Power Bits & TiN Coated | 156 158-159 |
| | ESD Safe Precision | 111 |
| | Ceramic Precision | 112 |
| | Precision | 113-114,121 |
| | Protturn Precision | 118 |
| | SYSTEM 4 Blades | 122 |
| | SYSTEM 4 Micro Bits | 127 |



Made in Germany

www.wihatools.com

Click on page number to view product

Torx® & Screw Holding Torx

| | <u>DESCRIPTION</u> | <u>Page</u> |
|--|---|-------------|
| | SoftFinish® Cushion Grip & Screw Holding | 15, 176 |
| | MicroFinish Non-Slip Grip | 16 |
| | 3K Series | 18 |
| | Protturn | 17 |
| | Insulated Cushion Grip | 85 |
| | SYSTEM 6 Blades | 19 |
| | Powerhandle | 16 |
| | Wing Handle | 22-177 |
| | Flag Handle | 22 |
| | L-Keys & Magic Spring | 22-23-176 |
| | T-handle & ComfortGrip | 20-21 |
| | PocketStar Fold Outs | 21 |
| | ESD Safe SoftFinish Cushion Grip | 68 |
| | Bit Sets | 150,156 |
| | Insert & Power Bits | 160-162 |
| | Sockets & Sets | 167-169 |
| | ESD Safe Precision | 111 |
| | Precision | 117,121,177 |
| | Protturn Precision | 120 |
| | SYSTEM 4 Blades | 123 |
| | SYSTEM 4 Micro Bit | 128 |

Tamper Resistant Torx® Index

| | <u>DESCRIPTION</u> | <u>Page</u> |
|--|-----------------------------|-------------|
| | SoftFinish® Cushion Grip | 15 |
| | SYSTEM 6 Blades | 19,77 |
| | L-Keys | 23 |
| | PocketStar Fold Outs | 21 |
| | Insert Bits | 161-162 |
| | Power Bits | 161-162 |
| | SYSTEM 4 Micro Bits | 128 |

TorxPlus® Index

| | <u>DESCRIPTION</u> | <u>Page</u> |
|--|-----------------------------|-------------|
| | Torque Blade | 29 |
| | SoftFinish® Cushion Grip | 24 |
| | Insert Bits | 161 |
| | Bit-Selector | 151 |
| | Power Bits | 161 |
| | T-handles | 24 |
| | L-Keys Short/Long Arm | 25 |
| | Wing Handle | 25 |

Tamper Resistant Hex Index

| | <u>DESCRIPTION</u> | <u>Page</u> |
|--|---------------------|-------------|
| | Insert Bits | 163 |
| | SYSTEM 4 Micro Bits | 127 |















Made in Germany









Toll Free: (800) 494-6104

Click on page number to view product







Hex Index

| | <u>DESCRIPTION</u> | <u>Page</u> |
|---|-------------------------|-------------|
|  | SYSTEM 6 Blades | 77 |
|  | T-handle & ComfortGrip | 37-38 |
|  | L-wrenches | 42-43 |
|  | Power Bits | 163 |
|  | Insert Bits | 163 |
|  | ESD Safe Precision | 112 |
|  | Precision | 114,121 |
|  | Proturn | 119 |
|  | SYSTEM 4 Blades | 123 |
|  | SYSTEM 4 Micro Bits | 127 |
|  | Sockets | 167-169 |
|  | Insert & Power Bit Sets | 150-151 |









Nut Drivers Index

| | <u>DESCRIPTION</u> | <u>Page</u> |
|---|-----------------------------|-------------|
|  | SoftFinish® Cushion Grip | 49-51 |
|  | Insulated Cushion Grip | 53,84 |
|  | SYSTEM 6 Blades | 77-78 |
|  | SYSTEM 4 Blades | 123 |
|  | T-handle | 52 |
|  | Nut Setters | 166 |
|  | ESD Safe Precision | 112 |
|  | Precision | 116,121 |



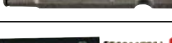



Ball End Hex Index

| | <u>DESCRIPTION</u> | <u>Page</u> |
|--|------------------------|-------------|
|  | 3K Series Screwdrivers | 41 |
|  | ComfortGrip T-handles | 37 |
|  | Precision | 115,121 |
|  | Proturn | 119 |
|  | SYSTEM 6 Blades | 78 |
|  | SYSTEM 4 Blades | 123 |
|  | Ball End L-keys & Sets | 34 |

MagicRing Index

|  | <u>DESCRIPTION</u> | <u>Page</u> |
|--|--------------------------------------|-------------|
|  | L-Keys | 33 |
|  | T-handles | 36 |
|  | Insert Bits | 162 |
|  | Power Bits | 162 |
|  | Bit-Selectors Insert & Power Bits | 152 |
|  | SoftFinish | 39-40 |
|  | PocketStars | 40 |

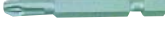
Pozidriv® Index

| | <u>DESCRIPTION</u> | <u>Page</u> |
|--|-----------------------------|-------------|
|  | SoftFinish® Cushion Grip | 67 |
|  | Square Handle Long | 74 |
|  | SYSTEM 6 Blades | 78 |
|  | SYSTEM 4 Blades | 122 |
|  | Insert Bits | 164 |
|  | Power Bits | 164 |
|  | Precision | 115 |





Made in Germany





www.wihatools.com

Click on page number to view product











Square Index

| | <u>DESCRIPTION</u> | <u>Page</u> |
|---|-----------------------------|-------------|
|  | SoftFinish® Cushion Grip | 67 |
|  | Insert Bits | 164-165 |
|  | Power Bits | 164 |











Wrenches Index

| | <u>DESCRIPTION</u> | <u>Page</u> |
|--|--------------------------------|-------------|
|  | Open End Inch/Metric | 54-56 |
|  | Soft Grip Wrenches Inch/Metric | 56 |
|  | Combination Inch/Metric | 57-60 |
|  | Box Wrenches Inch/Metric | 61 |







TorqueControl Index

| | <u>DESCRIPTION</u> | <u>Page</u> |
|--|-------------------------|-------------|
|  | TorqueFix Handle | 27 |
|  | TorqueVario Handle | 27 |
|  | Slotted Blade | 29 |
|  | Phillips Blade | 29 |
|  | Torx Blade | 29 |
|  | TorxPlus Blade | 29 |
|  | Insulated TorqueControl | 30 |
|  | Insulated Blades | 30 |
|  | ESD Safe TorqueControl | 31 |
|  | ESD Safe Blades | 31 |
|  | TorqueControl Sets | 28,31 |

Bit Holders Index

| | <u>DESCRIPTION</u> | <u>Page</u> |
|---|--|-------------|
|  | SoftFinish® Cushion Grip | 67,154 |
|  | MicroFinish Non-Slip Grip | 69,154 |
|  | Protturn | 17,154 |
|  | Insulated Bit Holder SoftFinish® Cushion Grip | 85,154 |
|  | 3K Ergo Bit Holder | 73,154 |
|  | Protturn Precision | 119,154 |
|  | T-handle | 52,154 |
|  | Powerhandle Bit Holder | 154 |
|  | ClicFix Quick Release | 166 |
|  | Magnetic Bit Holders | 166 |
|  | Retainig Ring Bit Holder | 166 |

Bit Sets Index

| | <u>DESCRIPTION</u> | <u>Page</u> |
|---|---------------------|-------------|
|  | Topra Bit Sets | 19,147 |
|  | Six in One Bit Sets | 149 |
|  | Bit Selector Sets | 150-152 |
|  | Power Bit-Selector | 151-152 |
|  | Bits Collector Set | 153 |
|  | MicroBit Sets | 128-129 |
|  | XSelectors | 148 |













Made in Germany

Toll Free: (800) 494-6104

Click on page number to view product

Miscellaneous Index

| | <u>DESCRIPTION</u> | <u>Page</u> |
|---|------------------------------------|-------------|
|  | SoftFinish Scraper Cushion Grip | 67 |
|  | Magnetizer/Demagnetizer | 75 |
|  | Round Awls | 80 |
|  | Square Reaming Awls | 80 |
|  | Dead Blow/Sledge Hammers | 47 |
|  | Hickory Handle Dead Blow | 47 |
|  | T-handle Socket Adapter | 167,52 |
|  | Precision Tool Clips | 117 |
|  | Lifters | 117,119 |
|  | Tool Stands/Racks | 67,117 |







High Performance Bits Index

| | <u>DESCRIPTION</u> | <u>Page</u> |
|---|---|-------------|
|  | Slotted Dura Insert Bits | 155 |
|  | Phillips Dura Insert Bits Insert/Power Bits | 155 |
|  | Pozidriv® Dura Insert Bits Insert/Power Bits | 155 |
|  | Torx® Dura Insert Bits | 155 |
|  | Slotted Diamond Bits | 155 |
|  | Phillips Diamond Bits Insert/Power Bits | 155 |







High Performance Bits Index

| | <u>DESCRIPTION</u> | <u>Page</u> |
|---|--|-------------|
|  | Pozidriv Diamond Bits | 155 |
|  | Torx® Diamond Bits | 155 |
|  | Phillips TiN Coated Insert/Power Bits | 156 |
|  | Torx® TiN Coated | 156 |

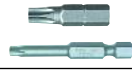
Standard Bits Index

| | <u>DESCRIPTION</u> | <u>Page</u> |
|--|--|-------------|
|  | Slotted Insert/Power Bits | 157 |
|  | Phillips Insert/Power Bits | 158-159 |
|  | Torx® Insert/Power Bits | 160-162 |
|  | Hex Metric & Inch Insert/Power Bits | 163 |
|  | Pozidriv® Insert/Power Bits | 164 |
|  | Square Insert/Power Bits | 164-165 |

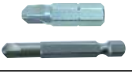
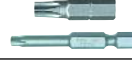
Specialty Bits Index

| | | |
|---|--|---------|
|  | Torx® Align Bits Insert/Power Bits | 161 |
|  | Tamper Resistant Torx Insert/Power Bits | 161-162 |
|  | Tamper Resistant Hex | 163 |
|  | Spanner | 165 |
|  | Triwing Insert/Power Bits | 165 |
|  | Torq Set Insert/Power Bits | 165 |
|  | TorxPlus® Insert/Power Bits | 161 |
|  | Micro Bits | 127-128 |















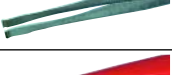

Made in Germany

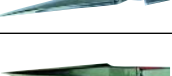







www.wihatools.com

Click on page number to view product







Tweezers Index

| | <u>DESCRIPTION</u> | <u>Page</u> |
|--|--------------------------|-------------|
|  | ESD Safe Tweezers | 131-133 |
|  | Microfine Tweezers | 133 |
|  | Standard Tweezers | 134-136 |
|  | Wafer Tweezers | 137-138 |
|  | Cutting Tweezers | 138 |
|  | Guide Pin Tweezers | 139-140 |
|  | Long Tweezers | 140 |
|  | Surface Mount Tweezers | 141-142 |
|  | Isolated Tweezers | 142 |
|  | Super Thin Tweezers | 142 |
|  | Self Closing Tweezers | 142-143 |
|  | Interchangeable Tweezers | 144 |
|  | Inspection Mirrors | 144 |
|  | All Stainless Excavators | 145 |
|  | All Stainless Probes | 145-146 |
|  | All Stainless Hooks | 146 |

Sockets Index

| | <u>DESCRIPTION</u> | <u>Page</u> |
|---|---|-------------|
|  | Torx 1/4" Drive | 167 |
|  | Torx 3/8" Drive | 167 |
|  | Torx 3/8" - 5/16" Bits | 167 |
|  | Tamper Resistant Torx 3/8" | 167 |
|  | External Torx Sockets 1/4", 3/8", 1/2" | 167 |
|  | Hex Bit Sockets 1/4" Drive | 167-168 |
|  | Hex Bit Sockets 3/8" Drive | 167-168 |
|  | 6" Bit Sockets 1/4" Drive | 168 |
|  | Socket Sets | 169 |

ESD Safe Tools

| | <u>DESCRIPTION</u> | <u>Page</u> |
|---|------------------------|-------------|
|  | TorqueControl Drivers | 31 |
|  | SoftFinish Drivers | 68 |
|  | SYSTEM 6 Handles | 76 |
|  | Pliers & Cutters | 104-109 |
|  | Precision Screwdrivers | 110-112 |
|  | SYSTEM 4 | 122,124-129 |
|  | Tweezers | 131-133 |









Made in Germany



Toll Free: (800) 494-6104

Click on page number to view product









ComfortGrip Pliers/Cutters Index

| | <u>DESCRIPTION</u> | <u>Page</u> |
|--|--------------------|-------------|
|  | Combination Pliers | 92 |
|  | Stripping Pliers | 92 |
|  | Long Nose | 93 |
|  | Bent Long Nose | 93 |
|  | Flat Nose | 93 |
|  | Adjustable Pliers | 94 |
|  | Diagonal Cutters | 95 |









ESD Safe Pliers/Cutters Index

| | <u>DESCRIPTION</u> | <u>Page</u> |
|---|--|-------------|
|  | Diagonal Cutters Small Tapered Head | 104 |
|  | Diagonal Cutters Wide Tapered Head | 105 |
|  | Diagonal Cutters Slim Oval Form | 105-106 |
|  | Diagonal Cutters Wide Oval Form | 106 |
|  | Oblique Angled Cutters Angled Cutters | 107 |
|  | End Cutters | 108 |
|  | Pliers Needle Nose, Round, Flat | 108-109 |

Standard Pliers/Cutters Index

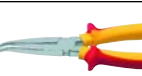
| | <u>DESCRIPTION</u> | <u>Page</u> |
|---|-----------------------|-------------|
|  | Combination Pliers | 96 |
|  | Stripping Pliers | 96 |
|  | Long Nose | 97 |
|  | Bent Long Nose | 97 |
|  | Flat Nose | 97 |
|  | Long Round Nose | 97 |
|  | Adjustable Pliers | 98 |
|  | Retaining Ring Pliers | 101 |
|  | High Leverage Cutters | 99 |
|  | Mason Nippers | 100 |

Insulated Pliers & Cutters

| | <u>DESCRIPTION</u> | <u>Page</u> |
|--|----------------------------|-------------|
|  | Combination | 88 |
|  | Heavy Duty Side Cutters | 89 |
|  | High Leverage Side Cutters | 89 |
|  | Cable Cutter | 89 |
|  | Bent Nose | 90 |
|  | Long Nose | 91 |
|  | Round Nose | 91 |
|  | Stripping Pliers | 91 |



Made in Germany

www.wihatools.com

Click on page number to view product

Torx® ,Security Torx, Screw Holding Torx

| | Description | Page |
|--|--|----------|
| | SoftFinish Screwdrivers Torx & Tamper Resistant Torx, Screw Holding | 15, 176 |
| | ESD Safe SoftFinish Drivers | 16 |
| | Powerhandle | 16 |
| | MicroFinish Non-Slip Grip | 16 |
| | Protturn Screwdrivers | 17 |
| | 3K Series Screwdrivers | 18 |
| | SYSTEM 6 Blades & Sets | 19 |
| | SYSTEM 6 Topra Ratchet | 19 |
| | ComfortGrip T-handle L-key | 20 |
| | T-handles | 21 |
| | PocketStar Fold Outs | 21 |
| | Wing Handle Styles | 22 & 177 |
| | Flag Handle Screwdrivers | 22 |
| | L-keys - Short Arm | 22 |
| | L-keys - Long Arm | 23, 177 |
| | Security L-keys Short | 23 |
| | TorqueControl Torx Blade | 29 |
| | Insulated Torx Screwdrivers | 85 |
| | XSelector Bit Sets | 148 |
| | Bit-Selectors | 150-153 |
| | Insert & Power Bits | 160-162 |
| | Torx Align Insert/Power Bits | 161 |
| | Tamper Resistant Bits | 161-162 |
| | TorxPlus Insert/Power Bits | 161 |
| | Carded Bits | 162 |
| | Dura Insert/Power Bits | 155 |
| | Diamond Insert/Power Bits | 155 |
| | TiN Coated Insert/Power Bits | 156 |
| | Sockets & Sets | 167-168 |

| | Description | Page |
|--|---|-------------|
| | E Torx Sockets & Sets | 167 |
| | Socket Sets On Rail | 167,169 |
| | ESD Safe Drivers | 111 |
| | Precision Drivers | 117,121,176 |
| | Protturn Precision Drivers | 120 |
| | SYS 4 Precision Handles/Blades/Sets | 122-126 |
| | SYSTEM 4 MicroBits Handles/Blades/Sets | 127-129 |
| | Torx Multi Bit Sets | 149 |

Wiha TorxPlus® Index

| | Description | Page |
|--|--------------------------|------|
| | SoftFinish Screwdrivers | 24 |
| | T-handles | 24 |
| | L-Keys | 25 |
| | Wing Handle Screwdrivers | 25 |
| | Insert & Power Bits | 161 |
| | Bit-Selectors | 151 |



TORX® REFERENCE CHART

| Size | Across Point Dimensions | | Approximate Torque | |
|------|-------------------------|------|--------------------|---------|
| | mm | Inch | Nm | In/Lbs. |
| T1 | .81 | .031 | 0.03 | .266 |
| T2 | .93 | .036 | 0.07 | .797 |
| T3 | 1.10 | .043 | 0.18 | 1.59 |
| T4 | 1.26 | .049 | 0.27 | 2.39 |
| T5 | 1.42 | .056 | 0.43 | 3.81 |
| T6 | 1.70 | .067 | 0.75 | 6.64 |
| T7 | 1.99 | .078 | 1.4 | 12.39 |
| T8 | 2.31 | .091 | 2.2 | 19.47 |
| T9 | 2.50 | .098 | 2.8 | 24.78 |
| T10 | 2.74 | .108 | 3.7 | 32.75 |
| T15 | 3.27 | .129 | 6.4 | 56.64 |
| T20 | 3.86 | .152 | 10.5 | 92.93 |
| T25 | 4.43 | .174 | 15.9 | 140.73 |
| T27 | 4.99 | .197 | 22.5 | 199.14 |
| T30 | 5.53 | .218 | 31.1 | 275.86 |
| T40 | 6.65 | .262 | 54.1 | 478.83 |
| T45 | 7.82 | .308 | 86.2 | 762.93 |
| T50 | 8.83 | .348 | 132 | 1168.30 |
| T55 | 11.22 | .442 | 252 | 2230.39 |
| T60 | 13.25 | .522 | 437 | 3867.78 |



Made in Germany

Toll Free: (800) 494-6104

Click image to view web page

Wiha TORX® SoftFinish® Screwdrivers - Ergonomic Cushion Grip Handle



362 TORX® SoftFinish® Grip. See Screw holding style pg 176

Round blade high alloy chrome-vanadium-molybdenum steel, hardened, chrome-plated, Wiha-Chromtop finish on tips. Wiha-SoftFinish® handle, multi-component, cushion grips.

| Item No. | Size | mm | Inch | mm | Inch | mm | Inch | lbs. | pkg. | Each |
|----------|------|-----|------|-----|------|-----|------|------|------|--------|
| 362 64 | T5 | 60 | 2.4 | 2.5 | .098 | 164 | 6.5 | .05 | 10 | \$5.00 |
| 362 66 | T6 | 60 | 2.4 | 3.5 | .139 | 164 | 6.5 | .06 | 10 | \$3.80 |
| 362 68 | T7 | 60 | 2.4 | 3.5 | .139 | 164 | 6.5 | .06 | 10 | \$3.60 |
| 362 70 | T8 | 60 | 2.4 | 3.5 | .139 | 164 | 6.5 | .06 | 10 | \$3.70 |
| 362 72 | T9 | 60 | 2.4 | 4.0 | .157 | 171 | 6.7 | .10 | 10 | \$4.20 |
| 362 74 | T10 | 80 | 3.0 | 4.0 | .157 | 191 | 7.5 | .11 | 10 | \$4.30 |
| 362 76 | T15 | 80 | 3.0 | 4.0 | .157 | 191 | 7.5 | .11 | 10 | \$4.50 |
| 362 78 | T20 | 100 | 4.0 | 4.0 | .157 | 211 | 8.3 | .11 | 10 | \$4.70 |
| 362 80 | T25 | 100 | 4.0 | 4.5 | .177 | 211 | 8.3 | .12 | 10 | \$5.40 |
| 362 82 | T27 | 115 | 4.5 | 5.5 | .216 | 233 | 9.2 | .19 | 10 | \$6.20 |
| 362 84 | T30 | 115 | 4.5 | 6.0 | .236 | 233 | 9.2 | .20 | 10 | \$7.40 |
| 362 86 | T40 | 130 | 5.1 | 7.0 | .275 | 254 | 10.0 | .27 | 10 | \$7.90 |
| 362 88 | T45 | 130 | 5.1 | 8.0 | .315 | 254 | 10.0 | .31 | 10 | \$8.40 |



362 TR Tamper Resistant TORX® Screwdriver With Wiha-SoftFinish® Handle. Round blade high alloy chrome-vanadium-molybdenum steel, hardened, chrome-plated, Wiha-Chromtop finish on tips. Wiha-SoftFinish® handle, multi-component, cushion grips.

| Item No. | Size | mm | Inch | mm | Inch | mm | Inch | lbs. | pkg. | Each |
|----------|------|-----|------|-----|------|-----|------|------|------|---------|
| 362 69 | TR7 | 60 | 2.4 | 3.5 | .139 | 164 | 6.5 | .06 | 10 | \$6.42 |
| 362 71 | TR8 | 60 | 2.4 | 3.5 | .139 | 164 | 6.5 | .06 | 10 | \$6.42 |
| 362 73 | TR9 | 60 | 2.4 | 4.0 | .157 | 171 | 6.7 | .10 | 10 | \$6.62 |
| 362 75 | TR10 | 80 | 3.0 | 4.0 | .157 | 191 | 7.5 | .11 | 10 | \$6.62 |
| 362 77 | TR15 | 80 | 3.0 | 4.0 | .157 | 191 | 7.5 | .11 | 10 | \$6.82 |
| 362 79 | TR20 | 100 | 4.0 | 4.0 | .157 | 211 | 8.3 | .11 | 10 | \$8.52 |
| 362 81 | TR25 | 100 | 4.0 | 4.5 | .177 | 211 | 8.3 | .11 | 10 | \$8.62 |
| 362 83 | TR27 | 115 | 4.5 | 5.5 | .216 | 233 | 9.2 | .19 | 10 | \$10.20 |
| 362 85 | TR30 | 115 | 4.5 | 6.0 | .236 | 233 | 9.2 | .20 | 10 | \$12.00 |
| 362 87 | TR40 | 130 | 5.1 | 7.0 | .275 | 254 | 10.0 | .28 | 10 | \$13.00 |

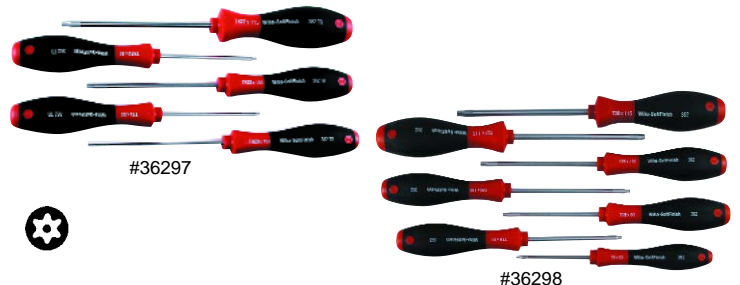

362 97 Set 5 Pcs. Tamper Resistant TORX®

| Item No. | Size | mm | Size | mm | lbs. | | |
|----------|--------|------|------|--------|------|-----|---------|
| 362 97 | 362 75 | TR10 | 80 | 362 81 | TR25 | 100 | .91 |
| | 362 77 | TR15 | 80 | 362 83 | TR27 | 115 | Each |
| | 362 79 | TR20 | 100 | | | | \$40.90 |

362 98 Set 7 Pcs. Tamper Resistant TORX®

| Item No. | Size | mm | Size | mm | lbs. | | |
|----------|--------|------|------|--------|------|-----|---------|
| 362 98 | 362 69 | TR7 | 60 | 362 77 | TR15 | 80 | .95 |
| | 362 71 | TR8 | 60 | 362 79 | TR20 | 100 | |
| | 362 73 | TR9 | 60 | 362 81 | TR25 | 100 | Each |
| | 362 75 | TR10 | 80 | | | | \$49.98 |



362 91 Set 6 Pcs. TORX® See Screw holding style pg 176

Round blade high alloy chrome-vanadium-molybdenum steel, hardened, chrome-plated. Wiha-Chromtop finish on tips. Wiha-SoftFinish® handle, multi-component, cushion grips.

| Item No. | Size | mm | Size | mm | lbs. | | |
|----------|--------|----|------|--------|------|----|---------|
| 362 91 | 362 66 | T6 | 60 | 362 72 | T9 | 60 | .77 |
| | 362 68 | T7 | 60 | 362 74 | T10 | 80 | Each |
| | 362 70 | T8 | 60 | 362 76 | T15 | 80 | \$23.98 |

362 94 Set 8 Pcs. TORX®

| Item No. | Size | mm | Size | mm | lbs. | | |
|----------|--------|-----|------|--------|------|-----|---------|
| 362 94 | 362 66 | T6 | 60 | 362 78 | T20 | 100 | 1.24 |
| | 362 70 | T8 | 60 | 362 80 | T25 | 100 | |
| | 362 74 | T10 | 80 | 362 82 | T27 | 115 | Each |
| | 362 76 | T15 | 80 | 362 84 | T30 | 115 | \$39.98 |

See Screw Holding TORX Page 176
See Torx Screwdrivers On Pages 63-68



Made in Germany

www.wihatools.com

Click image to view web page

Wiha SoftFinish ESD Safe Handle

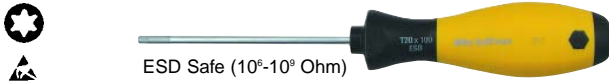

ESD Safe (10⁶-10⁹ Ohm)

362 ESD Safe TORX® Screwdriver, With Wiha-SoftFinish® Handle

DIN EN 61340-5-1/ 61340-5-2 Round blade, CVM steel, hardened, chrome-plated. Offers protection against electrostatic discharge. Dissipative SoftFinish® cushion grip handle, multi-component.

| Item | No. | Size | mm | Inch | mm | Inch | mm | Inch | lbs. | pkg. | Each |
|------|--------|------|-----|------|-----|------|-----|------|------|------|--------|
| | 362 04 | T4 | 60 | 2.4 | 3.5 | .139 | 164 | 6.5 | .06 | 10 | \$5.98 |
| | 362 06 | T6 | 60 | 2.4 | 3.5 | .139 | 164 | 6.5 | .06 | 10 | \$5.98 |
| | 362 08 | T8 | 60 | 2.4 | 3.5 | .139 | 164 | 6.5 | .06 | 10 | \$5.98 |
| | 362 09 | T9 | 60 | 2.4 | 4.0 | .157 | 171 | 6.7 | .10 | 10 | \$5.98 |
| | 362 18 | T10 | 80 | 3.0 | 4.0 | .157 | 191 | 7.5 | .11 | 10 | \$5.98 |
| | 362 19 | T15 | 80 | 3.0 | 4.0 | .157 | 191 | 7.5 | .11 | 10 | \$5.98 |
| | 362 24 | T20 | 100 | 4.0 | 4.0 | .157 | 211 | 8.3 | .11 | 10 | \$5.98 |



362 89 Set 6 Pcs. ESD Safe TORX® Screwdrivers

Includes: T6, T8, T9, T10, T15, T20 lbs. .81 Each \$33.98

Wiha Powerhandle TORX®

Made in Germany



362 TORX® Screwdriver, With Wiha-Powerhandle CVM steel

blade, hardened, chrome-plated. Wiha-powerhandle cellulose-acetate.

| Item | No. | Size | mm | Inch | mm | Inch | mm | Inch | lbs. | pkg. | Each |
|------|--------|------|-----|------|-----|------|-----|------|------|------|--------|
| | 362 05 | T5 | 50 | 2.0 | 2.5 | .098 | 110 | 4.3 | .03 | 10 | \$5.30 |
| | 362 10 | T6 | 50 | 2.0 | 3.5 | .139 | 125 | 4.9 | .06 | 10 | \$4.00 |
| | 362 12 | T7 | 50 | 2.0 | 3.5 | .139 | 125 | 4.9 | .06 | 10 | \$3.80 |
| | 362 15 | T8 | 60 | 2.4 | 3.5 | .139 | 135 | 5.3 | .06 | 10 | \$3.90 |
| | 362 20 | T9 | 60 | 2.4 | 4.0 | .157 | 140 | 5.5 | .09 | 10 | \$4.40 |
| | 362 25 | T10 | 80 | 3.0 | 4.0 | .157 | 170 | 6.7 | .13 | 10 | \$4.50 |
| | 362 30 | T15 | 80 | 3.0 | 4.0 | .157 | 170 | 6.7 | .13 | 10 | \$4.70 |
| | 362 35 | T20 | 100 | 4.0 | 4.0 | .157 | 200 | 7.9 | .17 | 10 | \$4.90 |
| | 362 40 | T25 | 100 | 4.0 | 4.5 | .177 | 200 | 7.9 | .18 | 10 | \$5.60 |
| | 362 45 | T27 | 115 | 4.5 | 5.5 | .216 | 215 | 8.5 | .20 | 10 | \$6.40 |
| | 362 50 | T30 | 115 | 4.5 | 6.0 | .236 | 225 | 8.9 | .28 | 10 | \$7.60 |



362 92 8 Pc. Set TORX® Blade high alloy CVM steel, hardened, chrome-plated. Wiha-powerhandle cellulose-acetate, impact resistant.

Item No. Includes: T6, T8, T10, T15, T20, T25, T27, T30 lbs. 1.45 Each \$40.20

362 93 6 Pc. Set TORX®

Item No. Includes: T6, T7, T8, T9, T10, T15 lbs. .78 Each \$25.60

Wiha TORX® MicroFinish Handle Non-Slip Grip

Wiha MicroFinish handle has a patented non-slip surface - it won't peel, crack or deteriorate when exposed to petroleum solvents. Oil and moisture flow away from the handle surface for a powerful, non-slip grip. You get maximum force and comfort with dry, oily or wet hands.

Safe, high density material, eliminates risk of sharp objects becoming embedded in the handle

Blades are hardened & chrome-plated

Exact fit precision ground tips

MicroFinish Handle with patented non-slip surface. Ergo handle shape for maximum comfort & exceptional torque transfer

Blade CVM, hardened & tempered tool steel, gives exceptional tool life, wear resistance & high torque performance



527 TORX® Screwdriver, With Wiha-MicroFinish Handle

Blade high alloy chrome-vanadium-molybdenum steel, hardened, chrome-plated. Wiha-MicroFinish handle, cellulose-acetate, impact resistant, non-slip, oil and grease resistant. Round blades.

| Item | No. | Size | mm | Inch | mm | Inch | mm | Inch | lbs. | pkg. | Each |
|------|--------|------|-----|------|-----|------|-----|------|------|------|---------|
| | 527 11 | T9 | 60 | 2.3 | 4.0 | .157 | 171 | 6.7 | .15 | 10 | \$5.50 |
| | 527 13 | T10 | 80 | 3.1 | 4.0 | .157 | 191 | 7.5 | .15 | 10 | \$5.60 |
| | 527 16 | T15 | 80 | 3.1 | 4.0 | .157 | 191 | 7.5 | .15 | 10 | \$5.90 |
| | 527 19 | T20 | 100 | 4.0 | 4.0 | .157 | 211 | 8.3 | .15 | 10 | \$6.20 |
| | 527 22 | T25 | 100 | 4.0 | 4.5 | .177 | 211 | 8.3 | .16 | 10 | \$7.10 |
| | 527 26 | T27 | 115 | 4.5 | 5.5 | .216 | 233 | 9.2 | .25 | 10 | \$8.20 |
| | 527 29 | T30 | 115 | 4.5 | 6.0 | .236 | 233 | 9.2 | .27 | 10 | \$9.80 |
| | 527 32 | T40 | 130 | 5.1 | 7.0 | .275 | 254 | 10.0 | .40 | 10 | \$10.70 |



527 90 Set 5 Pcs. TORX®

Blade chrome-vanadium-molybdenum steel, hardened, round blades chrome-plated. Wiha-MicroFinish handle, cellulose-acetate, impact resistant, non-slip, oil and grease resistant.

| Item | No. | Size | mm | Size | mm | lbs. | | |
|------|--------|--------|-----|------|--------|------|-----|---------|
| | 527 90 | 527 13 | T10 | 80 | 527 22 | T25 | 100 | 1.0 |
| | | 527 16 | T15 | 80 | 527 29 | T30 | 115 | Each |
| | | 527 19 | T20 | 100 | | | | \$34.80 |

See MicroFinish Non-Slip Grip Screwdrivers On Page 69-70



Made in Germany

Toll Free: (800) 494-6104

Click image to view web page

Wiha TORX® Protturn Screwdrivers



455 91 Set 6 Pcs. TORX®

| Item | | | | | | | |
|--------|--------|----|----|--------|-----|------|---------|
| No. | Size | mm | | Size | mm | lbs. | |
| 455 91 | 455 06 | T7 | 50 | 455 21 | T10 | 80 | .72 |
| | 455 11 | T8 | 60 | 455 26 | T15 | 80 | Each |
| | 455 16 | T9 | 60 | 455 31 | T20 | 100 | \$16.98 |

455 92 Set 8 Pcs. TORX®

| Item | | | | | | | |
|--------|--------|-----|----|--------|-----|------|---------|
| No. | Size | mm | | Size | mm | lbs. | |
| 455 92 | 455 11 | T8 | 60 | 455 31 | T20 | 100 | 1.07 |
| | 455 16 | T9 | 60 | 455 36 | T25 | 100 | |
| | 455 21 | T10 | 80 | 455 41 | T27 | 115 | Each |
| | 455 26 | T15 | 80 | 455 46 | T30 | 115 | \$25.98 |



455 TORX® Screwdriver, With Wiha-Protturn Handle
Blade high alloy CVM steel, hardened, black finish. Molded on ergonomic Wiha-Protturn handle, molded on, impact resistant.

| Item | | | | | | | | | | |
|--------|------|-----|------|-----|------|-----|------|------|------|--------|
| No. | Size | mm | Inch | mm | Inch | mm | Inch | lbs. | pkg. | Each |
| 455 05 | T6 | 50 | 2.0 | 3.5 | .139 | 129 | 5.1 | .05 | 10 | \$2.40 |
| 455 06 | T7 | 50 | 2.0 | 3.5 | .139 | 129 | 5.1 | .05 | 10 | \$2.20 |
| 455 11 | T8 | 60 | 2.4 | 3.5 | .139 | 139 | 5.5 | .06 | 10 | \$2.30 |
| 455 16 | T9 | 60 | 2.3 | 4.0 | .157 | 149 | 5.8 | .08 | 10 | \$2.60 |
| 455 21 | T10 | 80 | 3.1 | 4.0 | .157 | 170 | 6.7 | .10 | 10 | \$2.60 |
| 455 22 | T10 | 275 | 10.8 | 4.0 | .157 | 363 | 14.2 | .13 | 10 | \$4.30 |
| 455 26 | T15 | 80 | 3.1 | 4.0 | .157 | 170 | 6.7 | .10 | 10 | \$2.70 |
| 455 28 | T15 | 275 | 10.8 | 4.0 | .157 | 373 | 14.6 | .15 | 10 | \$4.70 |
| 455 31 | T20 | 100 | 4.0 | 4.0 | .157 | 190 | 7.5 | .11 | 10 | \$3.90 |
| 455 36 | T25 | 100 | 4.0 | 4.5 | .177 | 190 | 7.5 | .11 | 10 | \$3.30 |
| 455 41 | T27 | 115 | 4.5 | 5.5 | .216 | 215 | 8.4 | .11 | 10 | \$3.80 |
| 455 46 | T30 | 115 | 4.5 | 6.0 | .236 | 215 | 8.4 | .20 | 10 | \$4.50 |
| 455 51 | T40 | 130 | 5.1 | 7.0 | .275 | 240 | 9.4 | .28 | 10 | \$5.10 |
| 455 56 | T45 | 130 | 5.1 | 8.0 | .315 | 240 | 9.4 | .27 | 10 | \$5.40 |
| 455 61 | T50 | 130 | 5.1 | 9.0 | .354 | 240 | 9.4 | .31 | 10 | \$5.50 |



484 00 1/4" Bit Holding Screwdriver, With Wiha-Protturn Handle
Magnetic, holds bit and screw. Retainer out of stainless steel. Shaft CVM steel, nickel-plated. Handle, molded on, impact resistant.

| Item | | | | | | | | |
|--------|------|-----|------|-----|------|------|------|--------|
| No. | Size | mm | Inch | mm | Inch | lbs. | pcs. | each |
| 484 00 | 1/4 | 125 | 5.0 | 243 | 9.6 | .24 | 10 | \$6.28 |



484 95 Wiha-Protturn Handle Bit Holder & TORX® Bit-Selector Set
Magnetic, holds bit and screw. Retainer out of stainless steel. Shaft chrome-vanadium steel, nickel-plated.
Set includes 1/4" magnetic bit holder and 10 bits.

| | TORX® sizes: | | Each |
|--|------------------------------|-----|---------|
| | T10, T15, T20, T25, T27, T30 | .53 | \$21.98 |



Made in Germany

www.wihatools.com

Click image to view web page

Wiha TORX® 3K Series Screwdrivers and Sets



455 TORX® Screwdriver, With Wiha-3K Series Handle
Blade high alloy CVM steel, hardened, black finish. Molded on ergonomic Wiha-3K Series handle, molded on, impact resistant.

| Item No. | Size | mm | Inch | mm | Inch | mm | Inch | lbs. | pkg. | Each |
|----------|------|-----|------|-----|------|-----|------|------|------|--------|
| 455 04 | T6 | 60 | 2.0 | 3.2 | 9/64 | 145 | 5.7 | .06 | 10 | \$3.30 |
| 455 07 | T7 | 60 | 2.0 | 3.5 | 9/64 | 129 | 5.1 | .05 | 10 | \$3.30 |
| 455 08 | T8 | 60 | 2.4 | 3.5 | 9/64 | 139 | 5.5 | .06 | 10 | \$3.40 |
| 455 09 | T9 | 60 | 2.3 | 4.0 | 5/32 | 149 | 5.8 | .08 | 10 | \$3.60 |
| 455 10 | T10 | 80 | 3.1 | 4.0 | 5/32 | 170 | 6.7 | .10 | 10 | \$3.60 |
| 455 12 | T10 | 275 | 10.8 | 4.0 | 5/32 | 372 | 14.6 | .14 | 10 | \$5.40 |
| 455 15 | T15 | 80 | 4.0 | 4.0 | 5/32 | 190 | 7.5 | .11 | 10 | \$3.80 |
| 455 18 | T15 | 275 | 10.8 | 4.0 | 5/32 | 381 | 14.9 | .16 | 10 | \$5.50 |
| 455 20 | T20 | 100 | 4.5 | 5.5 | 7/32 | 215 | 8.4 | .11 | 10 | \$4.00 |
| 455 25 | T25 | 100 | 4.5 | 6.0 | 1/4 | 215 | 8.4 | .20 | 10 | \$4.30 |
| 455 27 | T27 | 115 | 5.1 | 7.0 | 9/32 | 240 | 9.4 | .28 | 10 | \$4.80 |
| 455 30 | T30 | 115 | 4.5 | 6.0 | 1/4 | 233 | 9.1 | .21 | 10 | \$5.40 |
| 455 40 | T40 | 130 | 5.1 | 7.0 | 9/32 | 248 | 9.7 | .25 | 10 | \$6.00 |
| 455 45 | T45 | 130 | 5.1 | 8.0 | 5/16 | 249 | 9.8 | .30 | 10 | \$6.10 |
| 455 50 | T50 | 130 | 5.1 | 9.0 | 3/8 | 249 | 9.8 | .33 | 10 | \$6.30 |



455 93 Set 5 Pcs. Torx®
Blade chrome-vanadium-molybdenum steel, hardened, black finish. Wiha-3k Ergo handle, cushion grip.

| Item No. | Size | mm | Size | mm | lbs. | | |
|----------|--------|-----|------|--------|------|-----|---------|
| 455 93 | 455 08 | T8 | 60 | 455 20 | T20 | 100 | .86 |
| | 455 10 | T10 | 80 | 455 25 | T25 | 100 | Each |
| | 455 15 | T15 | 80 | | | | \$17.98 |



455 98 Set 6 Pcs. Torx®
Blade chrome-vanadium-molybdenum steel, hardened, black finish. Wiha-3k Ergo handle, cushion grip.

| Item No. | Size | mm | Size | mm | lbs. | | |
|----------|--------|----|------|--------|------|----|---------|
| 455 98 | 455 04 | T6 | 60 | 455 09 | T9 | 60 | .88 |
| | 455 07 | T7 | 60 | 455 10 | T10 | 80 | Each |
| | 455 08 | T8 | 60 | 455 15 | T15 | 80 | \$20.98 |



455 95 Set 8 Pcs. Torx®
Blade chrome-vanadium-molybdenum steel, hardened, black finish. Wiha-3k Ergo handle, cushion grip.

| Item No. | Size | mm | Size | mm | lbs. | | |
|----------|--------|-----|------|--------|------|-----|---------|
| 455 95 | 455 08 | T8 | 60 | 455 20 | T20 | 100 | 1.36 |
| | 455 09 | T9 | 60 | 455 25 | T25 | 100 | |
| | 455 10 | T10 | 80 | 455 27 | T27 | 115 | Each |
| | 455 15 | T15 | 80 | 455 30 | T30 | 115 | \$31.98 |



455 96 Set 4 Pcs. Torx®
Blade chrome-vanadium-molybdenum steel, hardened, black finish. Wiha-3k Ergo handle, cushion grip.

| Item No. | Size | mm | Size | mm | lbs. | | |
|----------|--------|-----|------|--------|------|-----|---------|
| 455 96 | 455 10 | T10 | 80 | 455 20 | T20 | 100 | Each |
| | 455 15 | T15 | 80 | 455 25 | T25 | 100 | \$14.98 |



455 97 Set 11 Pcs. Torx® 3K Ergo Series Screwdriver Set
Blade chrome-vanadium-molybdenum steel, hardened, black finish. Wiha-3k Ergo handle, cushion grip.

| Item No. | Size | mm | Size | mm | lbs. | | |
|----------|--------|-----|------|--------|------|-----|---------|
| 455 97 | 455 04 | T6 | 60 | 455 20 | T20 | 100 | 1.72 |
| | 455 07 | T7 | 60 | 455 25 | T25 | 100 | |
| | 455 08 | T8 | 60 | 455 27 | T27 | 115 | |
| | 455 09 | T9 | 60 | 455 30 | T30 | 115 | |
| | 455 10 | T10 | 80 | 455 40 | T40 | 130 | Each |
| | 455 15 | T15 | 80 | | | | \$43.98 |



Made in Germany

Toll Free: (800) 494-6104

Click image to view web page

SYSTEM 6

Handles • Blades • Sets

Rotating cap turns freely while applying pressure to tight fasteners.

Collet lock eliminates loose fitting blades.



Narrow diameter allows 40% more turning clearance. Gives high visibility to fastener.

Long, slender grips for extended reach

See SYS 6 Handles on page 76

These blades can also be used in Topra Ratchet handle



107 SYSTEM 6 TORX® Interchangeable Blade, high alloy CVM tool steel, hardened, corrosion protected. **TORX®** on 6mm SYS 6 Hex.

| Item | Size | lbs. | pkg. | Each |
|--------|------|------|------|--------|
| 107 00 | T8 | .10 | 1 | \$4.50 |
| 107 03 | T9 | .10 | 1 | \$4.50 |
| 107 06 | T10 | .10 | 1 | \$4.50 |
| 107 09 | T15 | .10 | 1 | \$4.50 |
| 107 12 | T20 | .10 | 1 | \$4.50 |
| 107 15 | T25 | .10 | 1 | \$4.50 |
| 107 18 | T27 | .10 | 1 | \$4.50 |
| 107 21 | T30 | .10 | 1 | \$4.50 |
| 107 24 | T40 | .11 | 1 | \$4.50 |

These blades can also be used in Topra Ratchet handle



111 SYSTEM 6 Tamper Resistant TORX® Interchangeable Blade, high alloy CVM tool steel, hardened, corrosion protected. **TORX®** on 6mm SYS 6 Hex. Blade length 140mm/5.5".

| Item | Size | lbs. | pkg. | Each |
|--------|------|------|------|--------|
| 111 03 | TR7 | .09 | 1 | \$5.60 |
| 111 05 | TR8 | .09 | 1 | \$5.60 |
| 111 07 | TR9 | .09 | 1 | \$5.60 |
| 111 09 | TR10 | .09 | 1 | \$5.60 |
| 111 12 | TR15 | .09 | 1 | \$5.60 |
| 111 15 | TR20 | .09 | 1 | \$5.60 |
| 111 18 | TR25 | .09 | 1 | \$5.60 |
| 111 20 | TR27 | .09 | 1 | \$5.60 |
| 111 24 | TR30 | .11 | 1 | \$5.60 |



284 SYSTEM 6 TORX® Reversible Blade, high alloy CVM steel, hardened, chrome plated, Wiha vapor Chrome-Top finish on tips. **TORX®** on 6mm SYSTEM 6 Hex. Blade length 175mm/6.89".

| Item | Size | Size | lbs. | Each |
|--------|-----------|------|------|--------|
| 284 51 | T6 + T8 | | .08 | \$7.40 |
| 284 52 | T7 + T9 | | .08 | \$7.40 |
| 284 53 | T10 + T15 | | .08 | \$7.40 |
| 284 54 | T20 + T25 | | .08 | \$7.40 |
| 284 55 | T30 + T40 | | .09 | \$7.40 |



111 91 SYSTEM 6 Tamper Resistant TORX® Interchangeable Blade Set, 10 Pcs. in Durable Pouch. Set includes ESD Safe Precision and Dynamic handles & 9 interchangeable blades.

| Item | No. | lbs. | Each |
|------|--------|------|---------|
| | 111 91 | .84 | \$53.98 |

Tamper Resistant: TR7, TR8, TR9, TR10, TR15, TR20, TR25, TR27, TR30
ESD Safe Dynamic Handle



107 91 SYSTEM 6/4 TORX® Interchangeable Blade Set, 9 Pcs. in Durable Pouch. Set includes ESD Safe Precision and Dynamic handles and 7 Wiha interchangeable blades.

| Item | No. | lbs. | Each |
|------|--------|------|---------|
| | 107 91 | .71 | \$43.98 |

SYS 4: T5, T6, T7, T8, T9, T10, T15
SYS 6: T20, T25, T30
ESD Safe Precision & Dynamic Handle Set



Wiha Topra Ratchet Handle

282 Sets Topra Ratchet

Pistol Grip Handle with ergonomic design has free running mechanism. Instant clutch engagement allows constant turning pressure on the fastener.



| Item | Set Includes Topra Handle, Magnetic Bit Holder & The Following Bits: | lbs. |
|--------|--|--------------|
| 282 95 | TORX® Sizes: T7, T8, T9, T10, T15, T20, T25, T27, T30, T40 | .65 |
| | | Each \$45.88 |

| Item | Tamper Resistant TORX® Sizes: | lbs. |
|--------|---|--------------|
| 282 97 | TR7, TR8, TR9, TR10, TR15, TR20, TR25, TR27, TR30, TR40 | .65 |
| | | Each \$51.98 |



Made in Germany

www.wihatools.com

Click image to view web page

Wiha Torx® ComfortGrip T-handle L-Keys

Two Tools In One!

Through the handle side torque drive

Short and Long Arm In One Powerful Tool

Two component soft grip handle

Maximum Comfort & Maximum Power

Torx - Blades of CVM tool steel, through hardened durability, satin chrome finish

CRM-72 - Blade chrome-vanadium-molybdenum tool steel, through hardened durability, hard chrome finish.



364 ComfortGrip Torx T-handle Blade CVM steel, through hardened, satin chrome finish. Soft grips are molded on and include through the handle side torque drive.

| Item | | | | | |
|--------|------|-----|------|------|--------|
| No. | Size | mm | lbs. | pkg. | Each |
| 364 80 | T10 | 100 | 1.05 | 10 | \$5.60 |
| 364 81 | T15 | 100 | 1.30 | 10 | \$6.20 |
| 364 82 | T20 | 100 | 1.64 | 10 | \$7.00 |
| 364 83 | T25 | 150 | 1.79 | 10 | \$7.40 |
| 364 84 | T27 | 150 | 2.08 | 10 | \$8.30 |
| 364 86 | T30 | 150 | 2.30 | 10 | \$8.30 |
| 364 87 | T40 | 150 | 2.54 | 10 | \$8.90 |

364 97 Set 7 Pcs. Torx® ComfortGrips Blade CVM steel, hardened, chrome finish. Wiha soft grip T-handles are molded on and include through the handle side torque drive.

| Item | | | | | | | |
|--------|--------|-----|-----|--------|------|-----|---------|
| No. | Size | mm | mm | mm | lbs. | | |
| 364 97 | 364 80 | T10 | 100 | 364 84 | T27 | 150 | 1.53 |
| | 364 81 | T15 | 100 | 364 86 | T30 | 150 | |
| | 364 82 | T20 | 100 | 364 87 | T40 | 150 | Each |
| | 364 83 | T25 | 150 | | | | \$50.98 |

See
Wiha Tools
ComfortGrip
T-handle L-keys
in Hex Metric
& Inch on
Page 37



See Screw Holding Torx On Page 176-177



Made in Germany

Toll Free: (800) 494-6104

Click image to view web page

Wiha TORX® T-handle



364 TORX® Screwdriver, with Wiha-T-handle

Blade high alloy chrome-vanadium-molybdenum steel, hardened, chrome-plated. Wiha T-handle high quality plastic, impact resistant.

| Item | No. | Size | mm | Inch | mm | Inch | mm | Inch | lbs | pkg. | Each |
|--------|-----|------|-----|------|------|------|-----|------|-----|------|---------|
| 364 09 | T9 | 100 | 3.9 | 4.0 | 5/32 | 80 | 3.0 | .07 | 10 | | \$4.50 |
| 364 10 | T10 | 100 | 3.9 | 4.0 | 5/32 | 80 | 3.0 | .07 | 10 | | \$4.70 |
| 364 15 | T15 | 100 | 3.9 | 4.0 | 5/32 | 80 | 3.0 | .07 | 10 | | \$5.40 |
| 364 17 | T15 | 200 | 7.9 | 5.5 | 7/32 | 80 | 3.0 | .13 | 10 | | \$5.40 |
| 364 20 | T20 | 100 | 3.9 | 4.0 | 5/32 | 100 | 4.0 | .10 | 10 | | \$6.10 |
| 364 22 | T20 | 200 | 7.9 | 5.5 | 7/32 | 100 | 4.0 | .17 | 10 | | \$6.10 |
| 364 25 | T25 | 100 | 3.9 | 4.0 | 5/32 | 100 | 4.0 | .11 | 10 | | \$6.40 |
| 364 27 | T25 | 200 | 7.9 | 5.5 | 7/32 | 100 | 4.0 | .17 | 10 | | \$6.40 |
| 364 30 | T27 | 100 | 3.9 | 5.5 | 7/32 | 100 | 4.0 | .14 | 10 | | \$7.30 |
| 364 32 | T27 | 200 | 7.9 | 5.5 | 7/32 | 100 | 4.0 | .17 | 10 | | \$7.30 |
| 364 35 | T30 | 100 | 3.9 | 7.9 | 6.0 | 100 | 4.0 | .14 | 10 | | \$7.20 |
| 364 37 | T30 | 200 | 7.9 | 6.0 | 1/4 | 100 | 4.0 | .19 | 10 | | \$7.30 |
| 364 40 | T40 | 100 | 3.9 | 7.0 | 9/32 | 100 | 4.0 | .16 | 10 | | \$7.90 |
| 364 42 | T40 | 200 | 7.9 | 7.0 | 9/32 | 100 | 4.0 | .23 | 10 | | \$8.00 |
| 364 45 | T45 | 150 | 5.9 | 8.0 | 5/16 | 120 | 4.7 | .29 | 10 | | \$9.70 |
| 364 52 | T50 | 250 | 9.8 | 9.0 | 3/8 | 120 | 4.7 | .45 | 10 | | \$11.90 |
| 364 55 | T55 | 150 | 5.9 | 12.0 | 1/2 | 120 | 4.7 | .50 | 10 | | \$14.50 |
| 364 60 | T60 | 150 | 5.9 | 14.0 | 9/16 | 105 | 4.7 | .61 | 10 | | \$17.10 |



364 92 Set 7 Pc. TORX® T-handle.

Blade CVM steel, hardened, chrome-plated. Wiha-T-handle high quality plastic, impact resistant.

| Item | No. | Size | mm | Size | mm | lbs. | |
|--------|--------|------|-----|--------|-----|------|---------|
| 364 92 | 364 09 | T9 | 100 | 364 27 | T25 | 200 | 1.24 |
| | 364 10 | T10 | 100 | 364 32 | T27 | 200 | |
| | 364 17 | T15 | 200 | 364 37 | T30 | 200 | Each |
| | 364 22 | T20 | 200 | | | | \$41.92 |

364 90 TORX® Set in Metal Stand, 7 Pc. Set

Wiha T-handle includes TORX® sizes:
T10, 15, 20, 25, 30 x 100mm
T40 x 200mm, T50 x 250mm

| Item | No. | lbs. | pkg. | Each |
|--------|-----|------|------|---------|
| 364 90 | | 2.65 | 1 | \$59.98 |



Wiha TORX® PocketStar



363 96 TORX® PocketStar Fold Outs, 7 Pc. Set

High alloy CVM steel, hardened, molded ergonomic handle.

| Item No | Size | Each | |
|---|------------|------|---------|
| 363 96 | PocketStar | .22 | \$13.24 |
| Torx: T7, T8, T9, T10, T15, T20, T25 | | | |

363 98 TORX® PocketStar Fold Outs, 8 Pc. Set

High alloy CVM steel, hardened, molded ergonomic handle.

| Item No. | Size | Each | |
|--|------------|------|---------|
| 363 98 | PocketStar | .24 | \$16.38 |
| Torx: T9, T10, T15, T20, T25, T27, T30, T40 | | | |



363 95 Tamper Resistant TORX® PocketStar Fold Outs, 7 Pc. Set

High alloy CVM steel, hardened, molded ergonomic handle.

| Item No. | Size | Each | |
|---|------------|------|---------|
| 363 95 | PocketStar | .22 | \$19.28 |
| TR Torx: TR7, TR8, TR9, TR10, TR15, TR20, TR25 | | | |

363 97 Tamper Resistant TORX® PocketStar Fold Outs, 8 Pc. Set

High alloy CVM steel, hardened, molded ergonomic handle.

| Item No. | Size | Each | |
|--|------------|------|---------|
| 363 97 | PocketStar | .24 | \$23.40 |
| TR Torx: TR9, TR10, TR15, TR20, R25, TR27, TR30, TR40 | | | |

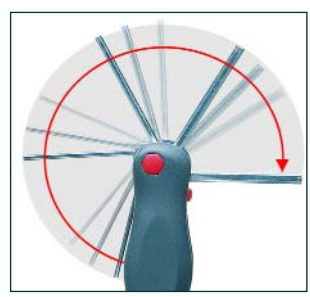



Made in Germany

www.wihatools.com

Click image to view web page

Wiha TORX® Tools



365 TORX® Wing Handle - Also See ScrewHolding style on pg 177

Especially for use with indexable carbide tooling and also for working in confined spaces. Blade high alloy CVM steel, hardened, black finish. Wing handle high quality plastic, impact resistant.

| Item | No. | Size | mm | Inch | mm | Inch | mm | Inch | lbs. | pkg. | Each |
|------|--------|------|----|------|----|------|----|------|------|------|--------|
| | 365 10 | T6 | 50 | 2.0 | 85 | 3.3 | 40 | 1.6 | .02 | 10 | \$3.10 |
| | 365 12 | T7 | 50 | 2.0 | 85 | 3.3 | 40 | 1.6 | .02 | 10 | \$3.10 |
| | 365 15 | T8 | 50 | 2.0 | 85 | 3.3 | 40 | 1.6 | .02 | 10 | \$3.10 |
| | 365 20 | T9 | 50 | 2.0 | 85 | 3.3 | 40 | 1.6 | .02 | 10 | \$3.10 |
| | 365 25 | T10 | 50 | 2.0 | 85 | 3.3 | 40 | 1.6 | .02 | 10 | \$3.10 |
| | 365 30 | T15 | 50 | 2.0 | 85 | 3.3 | 40 | 1.6 | .02 | 10 | \$3.10 |
| | 365 35 | T20 | 50 | 2.0 | 85 | 3.3 | 40 | 1.6 | .02 | 10 | \$3.10 |



365 90 Wing Handle TORX® Set, 7 Pc. in Metal Stand

Equipped with T6, T7, T8, T9, T10, T15, T20 Each \$25.48



370 TORX® Screwdriver, With Flag Handle

Especially for use with indexable carbide tooling and also for working in confined spaces. Blade high alloy CVM steel, hardened, black finish. Flag handle high quality plastic, impact resistant.

| Item | No. | Size | mm | Inch | mm | Inch | mm | Inch | lbs. | pkg. | Each |
|------|--------|------|----|------|----|------|------|------|------|------|--------|
| | 370 13 | T5 | 35 | 1.38 | 67 | 2.64 | 19.0 | .75 | .01 | 10 | \$2.90 |
| | 370 16 | T6 | 35 | 1.38 | 67 | 2.64 | 19.0 | .75 | .01 | 10 | \$2.90 |
| | 370 19 | T7 | 35 | 1.38 | 67 | 2.64 | 19.0 | .75 | .01 | 10 | \$2.90 |
| | 370 22 | T8 | 40 | 1.58 | 72 | 2.84 | 19.0 | .75 | .01 | 10 | \$2.90 |
| | 370 26 | T9 | 40 | 1.58 | 73 | 2.89 | 23.5 | .93 | .01 | 10 | \$2.90 |
| | 370 29 | T10 | 40 | 1.58 | 73 | 2.89 | 23.5 | .93 | .01 | 10 | \$2.90 |
| | 370 32 | T15 | 45 | 1.77 | 80 | 3.15 | 28.0 | 1.10 | .02 | 10 | \$2.90 |
| | 370 36 | T20 | 45 | 1.77 | 80 | 3.15 | 28.0 | 1.10 | .02 | 10 | \$2.90 |



370 90 Flag Handle TORX® Set, 7 Pc. in Metal Stand

Equipped with T6, T7, T8, T9, T10, T15, T20 Each \$22.48

Wiha TORX® Short Arm L-keys



363 TORX® L-key, Short Arm- Also See ScrewHolding style on pg 177

High alloy chrome-vanadium-molybdenum steel, hardened, black finish.

| Item | No. | Size | mm | Inch | mm | Inch | lbs. | pkg. | Each |
|------|--------|------|-----|------|----|------|------|------|--------|
| | 363 05 | T5 | 36 | 1.4 | 16 | .6 | .01 | 10 | \$1.66 |
| | 363 06 | T6 | 38 | 1.5 | 16 | .6 | .01 | 10 | \$1.66 |
| | 363 07 | T7 | 41 | 1.6 | 16 | .6 | .01 | 10 | \$1.66 |
| | 363 08 | T8 | 44 | 1.7 | 16 | .6 | .01 | 10 | \$1.66 |
| | 363 09 | T9 | 48 | 1.9 | 16 | .6 | .01 | 10 | \$1.66 |
| | 363 10 | T10 | 51 | 2.0 | 17 | .6 | .01 | 10 | \$1.66 |
| | 363 15 | T15 | 54 | 2.1 | 18 | .7 | .01 | 10 | \$1.66 |
| | 363 20 | T20 | 57 | 2.2 | 19 | .7 | .01 | 10 | \$1.66 |
| | 363 25 | T25 | 60 | 2.3 | 20 | .8 | .02 | 10 | \$1.66 |
| | 363 27 | T27 | 64 | 2.5 | 21 | .8 | .03 | 10 | \$1.66 |
| | 363 30 | T30 | 70 | 2.7 | 24 | .9 | .05 | 10 | \$2.34 |
| | 363 40 | T40 | 76 | 2.9 | 26 | 1.0 | .06 | 10 | \$3.34 |
| | 363 45 | T45 | 82 | 3.2 | 28 | 1.1 | .09 | 10 | \$4.26 |
| | 363 50 | T50 | 95 | 3.7 | 32 | 1.2 | .13 | 10 | \$4.66 |
| | 363 55 | T55 | 108 | 4.2 | 35 | 1.4 | .27 | 10 | \$6.10 |
| | 363 60 | T60 | 120 | 4.7 | 38 | 1.5 | .40 | 10 | \$7.50 |



363 92 TORX® Set, 7 Pc. in Plastic Holder

Equipped with T6, T7, T8, T9, T10, T15, T20

| Item | No. | lbs. | pkg. | Each |
|------|--------|------|------|---------|
| | 363 92 | .10 | 1 | \$13.38 |

363 94 TORX® Set, 9 Pc. in Plastic Holder

Equipped with T8, T9, T10, T15, T20, T25, T27, T30, T40

| Item | No. | lbs. | pkg. | Each |
|------|--------|------|------|---------|
| | 363 94 | .30 | 1 | \$18.60 |



363 90 TORX® Set, 9 Pc.

In metal stand for TORX® keys, equipped with T10, T15, T20, T25, T30, T40, T50, T55, T60

| Item | No. | lbs. | pkg. | Each |
|------|--------|------|------|---------|
| | 363 90 | 2.34 | 1 | \$43.88 |



Made in Germany

Toll Free: (800) 494-6104

Click image to view web page

Wiha TORX® Long Arm L-keys



Wiha Tamper Resistant TORX® L-keys



366 TORX® L-key, Long Arm Also See ScrewHolding Torx pg 177
High alloy chrome-vanadium-molybdenum steel, hardened, black finish.

| Item No. | Size | mm | Inch | mm | Inch | lbs. | pkg. | Each |
|----------|------|-----|------|----|------|------|------|--------|
| 366 45 | T5 | 72 | 2.8 | 13 | .5 | .06 | 10 | \$2.80 |
| 366 46 | T6 | 80 | 3.1 | 15 | .6 | .07 | 10 | \$2.60 |
| 366 47 | T7 | 88 | 3.4 | 18 | .7 | .10 | 10 | \$2.10 |
| 366 48 | T8 | 101 | 4.0 | 20 | .8 | .13 | 10 | \$2.20 |
| 366 49 | T9 | 111 | 4.3 | 21 | .8 | .17 | 10 | \$2.30 |
| 366 50 | T10 | 121 | 4.7 | 23 | .9 | .23 | 10 | \$2.30 |
| 366 51 | T15 | 136 | 5.3 | 27 | 1.1 | .33 | 10 | \$2.30 |
| 366 52 | T20 | 148 | 5.8 | 29 | 1.1 | .44 | 10 | \$2.30 |
| 366 53 | T25 | 163 | 6.4 | 33 | 1.3 | .65 | 10 | \$2.30 |
| 366 54 | T27 | 170 | 6.7 | 36 | 1.4 | .98 | 10 | \$2.30 |
| 366 55 | T30 | 178 | 7.0 | 38 | 1.5 | 1.27 | 10 | \$3.10 |
| 366 59 | T40 | 188 | 7.4 | 43 | 1.7 | 2.09 | 10 | \$3.80 |
| 366 61 | T50 | 200 | 7.8 | 50 | 2.0 | 3.14 | 10 | \$4.60 |

363 Tamper Resistant TORX® L-key, Short Arm
High alloy CVM steel, hardened, black finish.

| Item No. | Size | mm | Inch | mm | Inch | lbs. | pkg. | Each |
|----------|------|-----|------|----|------|------|------|--------|
| 363 21 | TR7 | 41 | 1.6 | 16 | .6 | .01 | 10 | \$2.30 |
| 363 23 | TR8 | 44 | 1.7 | 16 | .6 | .01 | 10 | \$2.30 |
| 363 26 | TR9 | 48 | 1.9 | 16 | .6 | .01 | 10 | \$2.30 |
| 363 28 | TR10 | 51 | 2.0 | 17 | .6 | .01 | 10 | \$2.30 |
| 363 29 | TR15 | 54 | 2.1 | 18 | .7 | .01 | 10 | \$2.30 |
| 363 32 | TR20 | 57 | 2.2 | 19 | .7 | .02 | 10 | \$2.30 |
| 363 35 | TR25 | 60 | 2.4 | 20 | .8 | .02 | 10 | \$2.30 |
| 363 37 | TR27 | 68 | 2.7 | 21 | .8 | .03 | 10 | \$2.60 |
| 363 39 | TR30 | 70 | 2.7 | 24 | .9 | .04 | 10 | \$3.10 |
| 363 42 | TR40 | 76 | 3.0 | 26 | 1.0 | .06 | 10 | \$3.80 |
| 363 46 | TR45 | 82 | 3.2 | 28 | 1.1 | .09 | 10 | \$5.66 |
| 363 52 | TR50 | 95 | 3.7 | 32 | 1.2 | .13 | 10 | \$6.34 |
| 363 57 | TR55 | 108 | 4.2 | 35 | 1.4 | .27 | 10 | \$9.64 |



366 99 Long Arm TORX® Set, 13 Pc. in ProStar Holder
Equipped with T5, T6, T7, T8, T9, T10, T15, T20, T25, T27, T30, T40, T50

| Item No. | lbs. | pkg. | Each |
|----------|------|------|---------|
| 366 99 | 1.13 | 1 | \$34.98 |



363 93 Tamper Resistant TORX® Set, 9 Pcs. in Plastic Holder
Equipped with TR8, TR9, TR10, TR15, TR20, TR25, TR27, TR30, TR40

| Item No. | lbs. | pkg. | Each |
|----------|------|------|---------|
| 363 93 | .30 | 1 | \$23.20 |



ProStar Holder



Made in Germany

www.wihatools.com

Click image to view web page

The TORXPlus® Advantage

The TorxPlus® Drive System offers 100% improvement in driver bit fatigue & 25% average improvement in driver bit torsional strength. In addition its unique design provides optimum torque transfer and eliminates the need for excessive end load pressure while driving the fastener. The TorxPlus® configuration also virtually eliminates tool "camout" and slippage that can damage the head of the fastener and cause reduced tool life.

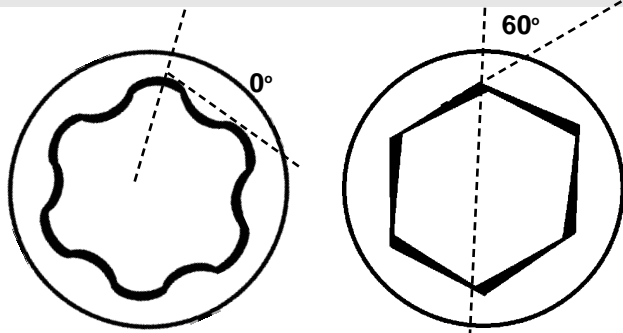

Not for use in standard Torx fasteners

- Broad Surface For Driving
- Features 0° Drive Angle Between The Fastener & Driver
- Greater Engagement Depth



362 TORXPlus® Screwdriver With Wiha-SoftFinish Handle. Round blade high alloy Chrome-vanadium-molybdenum tool steel, hardened, chrome-plated, Wiha-Chromtop finish on tips.

| Item No. | Size | mm | Inch | mm | Inch | mm | Inch | lbs. | pkg. | Each |
|----------|------|-----|------|-----|------|-----|------|------|------|--------|
| 362 11 | IP6 | 60 | 2.4 | 3.5 | .139 | 164 | 6.5 | .06 | 10 | \$3.80 |
| 362 23 | IP7 | 60 | 2.4 | 3.5 | .139 | 164 | 6.5 | .06 | 10 | \$3.60 |
| 362 28 | IP8 | 60 | 2.4 | 4.0 | .157 | 171 | 6.7 | .10 | 10 | \$3.70 |
| 362 29 | IP9 | 60 | 3.0 | 4.0 | .157 | 171 | 6.7 | .11 | 10 | \$4.20 |
| 362 33 | IP10 | 80 | 3.0 | 4.0 | .157 | 191 | 7.5 | .11 | 10 | \$4.30 |
| 362 38 | IP15 | 80 | 3.0 | 4.0 | .157 | 191 | 7.5 | .11 | 10 | \$4.50 |
| 362 39 | IP20 | 100 | 4.0 | 4.5 | .177 | 211 | 8.3 | .11 | 10 | \$4.70 |
| 362 43 | IP25 | 100 | 4.0 | 5.5 | .216 | 211 | 8.3 | .19 | 10 | \$5.40 |
| 362 48 | IP27 | 115 | 4.5 | 6.0 | .236 | 233 | 9.2 | .20 | 10 | \$6.20 |
| 362 53 | IP30 | 115 | 4.5 | 7.0 | .275 | 233 | 9.2 | .28 | 10 | \$7.40 |
| 362 55 | IP40 | 130 | 5.1 | 7.0 | .275 | 254 | 10.0 | .28 | 10 | \$7.90 |



362 99 Set 7 Pcs. TORXPlus®

Blade high alloy CVM steel, hardened, chrome-plated. Wiha powerhandle cellulose-acetate, impact resistant.

| Item No. | Size | mm | Size | mm | lbs. | | |
|----------|--------|------|------|--------|------|-----|---------|
| 362 99 | 362 28 | IP8 | 60 | 362 43 | IP25 | 100 | 1.23 |
| | 362 33 | IP10 | 80 | 362 53 | IP30 | 115 | |
| | 362 38 | IP15 | 80 | 362 55 | IP40 | 130 | Each |
| | 362 39 | IP20 | 100 | | | | \$37.90 |

Wiha T-handle TORXPlus®



364 TORXPlus® screwdriver, with Wiha-T-handle

Blade high alloy chrome-vanadium-molybdenum steel, hardened, chrome-plated. Wiha T-handle high quality plastic, impact resistant.

| Item No. | Size | mm | Inch | mm | Inch | mm | Inch | lbs | pkg. | Each |
|----------|------|-----|------|-----|------|-----|------|-----|------|--------|
| 364 61 | IP9 | 100 | 3.9 | 4.0 | .157 | 80 | 3.0 | .07 | 10 | \$4.98 |
| 364 63 | IP10 | 100 | 3.9 | 4.0 | .157 | 80 | 3.0 | .07 | 10 | \$5.98 |
| 364 66 | IP15 | 100 | 3.9 | 4.0 | .157 | 80 | 3.0 | .07 | 10 | \$5.98 |
| 364 69 | IP20 | 100 | 3.9 | 4.0 | .157 | 80 | 3.0 | .10 | 10 | \$6.68 |
| 364 72 | IP25 | 150 | 5.9 | 8.0 | .315 | 120 | 4.7 | .13 | 10 | \$6.98 |
| 364 74 | IP27 | 150 | 5.9 | 8.0 | .315 | 120 | 4.7 | .14 | 10 | \$7.98 |
| 364 76 | IP30 | 150 | 5.9 | 8.0 | .315 | 120 | 4.7 | .16 | 10 | \$7.98 |
| 364 78 | IP40 | 150 | 5.9 | 8.0 | .315 | 120 | 4.7 | .20 | 10 | \$8.78 |



364 96 Set 6 Pcs. TORXPlus® T-handles

Blade CVM steel, hardened, chrome-plated. Chromtop blade tips. Wiha T-handle high quality plastic, impact resistant.

| Item No. | Size | mm | Size | mm | lbs. | | |
|----------|--------|------|------|--------|------|-----|---------|
| 364 96 | 364 63 | IP10 | 100 | 364 72 | IP25 | 150 | 1.01 |
| | 364 66 | IP15 | 100 | 364 74 | IP27 | 150 | Each |
| | 364 69 | IP20 | 100 | 364 76 | IP30 | 150 | \$41.58 |



Made in Germany

Toll Free: (800) 494-6104

Click image to view web page

TORXPlus®

For Improved Torque and Longer Tool Life

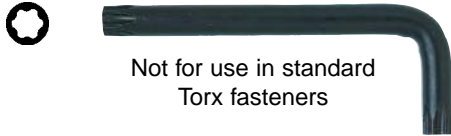

Not for use in standard Torx fasteners

361 TORXPlus® L-key, Short Arm
High alloy chrome-vanadium-molybdenum steel, hardened, black finish.

| Item No. | Size | mm | Inch | mm | Inch | lbs. | pkg. | Each |
|----------|------|----|------|----|------|------|------|--------|
| 361 06 | IP6 | 38 | 1.5 | 16 | .6 | .01 | 10 | \$2.24 |
| 361 07 | IP7 | 41 | 1.6 | 16 | .6 | .01 | 10 | \$2.24 |
| 361 08 | IP8 | 44 | 1.7 | 16 | .6 | .01 | 10 | \$2.24 |
| 361 09 | IP9 | 48 | 1.9 | 16 | .6 | .01 | 10 | \$2.24 |
| 361 10 | IP10 | 51 | 2.0 | 16 | .6 | .01 | 10 | \$2.24 |
| 361 15 | IP15 | 54 | 2.1 | 17 | .6 | .01 | 10 | \$2.24 |
| 361 20 | IP20 | 57 | 2.2 | 18 | .7 | .01 | 10 | \$2.24 |
| 361 25 | IP25 | 60 | 2.4 | 19 | .7 | .01 | 10 | \$2.24 |
| 361 27 | IP27 | 68 | 2.6 | 20 | .8 | .02 | 10 | \$2.24 |
| 361 30 | IP30 | 70 | 2.7 | 21 | .8 | .03 | 10 | \$3.10 |
| 361 40 | IP40 | 76 | 2.9 | 24 | .9 | .05 | 10 | \$4.38 |



Not for use in standard Torx fasteners

366 TORXPlus® L-key, Long Arm
High alloy chrome-vanadium-molybdenum steel, hardened, black finish.

| Item No. | Size | mm | Inch | mm | Inch | lbs. | pkg. | Each |
|----------|------|-----|------|----|------|------|------|--------|
| 366 06 | IP6 | 66 | 2.6 | 16 | .6 | .01 | 10 | \$2.34 |
| 366 07 | IP7 | 71 | 2.8 | 16 | .6 | .01 | 10 | \$2.34 |
| 366 08 | IP8 | 75 | 3.0 | 16 | .6 | .01 | 10 | \$2.34 |
| 366 09 | IP9 | 80 | 3.2 | 16 | .6 | .01 | 10 | \$2.34 |
| 366 10 | IP10 | 85 | 3.4 | 16 | .6 | .01 | 10 | \$2.34 |
| 366 15 | IP15 | 90 | 3.6 | 17 | .6 | .02 | 10 | \$2.34 |
| 366 20 | IP20 | 96 | 3.8 | 18 | .7 | .02 | 10 | \$2.34 |
| 366 25 | IP25 | 102 | 4.0 | 19 | .7 | .03 | 10 | \$2.34 |
| 366 27 | IP27 | 108 | 4.3 | 20 | .8 | .05 | 10 | \$2.34 |
| 366 30 | IP30 | 116 | 4.6 | 21 | .8 | .06 | 10 | \$3.16 |
| 366 40 | IP40 | 124 | 4.9 | 24 | .9 | .09 | 10 | \$4.48 |



#36197



#36199

361 97 TORXPlus® L-key, Short Arm 7 Pc. Set In Holder
High alloy chrome-vanadium-molybdenum steel, hardened, black finish.

| Item No. | lbs. | pkg. | Set includes the following L-keys: | Each |
|----------|------|------|--------------------------------------|---------|
| 361 97 | .10 | 1 | IP6, IP7, IP8, IP9, IP10, IP15, IP20 | \$16.98 |

361 99 TORXPlus® L-key, Short Arm 9 Pc. Set In Holder
Set includes the following L-keys:

| Item No. | lbs. | pkg. | Set includes the following L-keys: | Each |
|----------|------|------|--|---------|
| 361 99 | .30 | 1 | IP8, IP9, IP10, IP15, IP20, IP25, IP27, IP30, IP40 | \$23.98 |

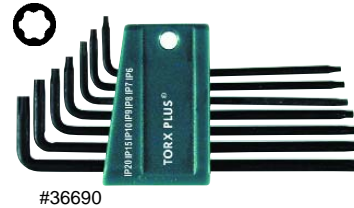

#36690

366 90 TORXPlus® L-key, Long Arm 7 Pc. Set In Holder
High alloy chrome-vanadium-molybdenum steel, hardened, black finish.

| Item No. | lbs. | pkg. | Set includes the following L-keys: | Each |
|----------|------|------|--------------------------------------|---------|
| 366 90 | .22 | 1 | IP6, IP7, IP8, IP9, IP10, IP15, IP20 | \$17.98 |

366 91 TORXPlus® L-key, Long Arm 9 Pc. Set In Holder
Set includes the following L-keys:

| Item No. | lbs. | pkg. | Set includes the following L-keys: | Each |
|----------|------|------|--|---------|
| 366 91 | .35 | 1 | IP8, IP9, IP10, IP15, IP20, IP25, IP27, IP30, IP40 | \$25.48 |

TORXPlus®

Not for use in standard Torx fasteners



365 TORXPlus® Screwdriver, With Wing Handle
Especially for use with indexable carbide tooling and also for working in confined spaces. Blade high alloy CVM steel, hardened, black finish. Wing handle high quality plastic, impact resistant.

| Item No. | Size | mm | Inch | mm | Inch | mm | Inch | lbs. | pkg. | Each |
|----------|------|----|------|----|------|----|------|------|------|--------|
| 365 40 | IP5 | 50 | 2.0 | 85 | 3.3 | 40 | 1.6 | .02 | 10 | \$3.30 |
| 365 42 | IP6 | 50 | 2.0 | 85 | 3.3 | 40 | 1.6 | .02 | 10 | \$3.30 |
| 365 44 | IP7 | 50 | 2.0 | 85 | 3.3 | 40 | 1.6 | .02 | 10 | \$3.30 |
| 365 46 | IP8 | 50 | 2.0 | 85 | 3.3 | 40 | 1.6 | .02 | 10 | \$3.30 |
| 365 48 | IP9 | 50 | 2.0 | 85 | 3.3 | 40 | 1.6 | .02 | 10 | \$3.70 |
| 365 50 | IP10 | 50 | 2.0 | 85 | 3.3 | 40 | 1.6 | .02 | 10 | \$3.70 |
| 365 52 | IP15 | 50 | 2.0 | 85 | 3.3 | 40 | 1.6 | .02 | 10 | \$3.90 |
| 365 54 | IP20 | 50 | 2.0 | 85 | 3.3 | 40 | 1.6 | .02 | 10 | \$4.30 |



365 92 TORXPlus® 7 Pcs. Wing Handle Set in metal stand
Equipped with IP6, IP7, IP8, IP9, IP10, IP15, IP20

| Item No. | lbs. | pkg. | Each |
|----------|------|------|---------|
| 365 92 | .38 | 1 | \$33.98 |



Made in Germany

Notes:

Lined area for notes

Wiha TorqueControl Index

| | Description | Page |
|--|---|------|
| | TorqueControl Fix Handle | 27 |
| | TorqueVario Handle | 27 |
| | TorqueVario Handle (Newton Meter Scale) | 27 |
| | TorqueControl Sets | 28 |
| | TorqueControl Adapters | 28 |
| | Standard Blades | 29 |
| | Insulated TorqueVario | 30 |
| | Insulated Blades | 30 |
| | ESD Safe TorqueVario Handle | 31 |
| | ESD Safe Blades | 31 |
| | ESD Safe Set TorqueVario | 31 |

TorqueVario-S ESD was developed for use in anti-static environments and TorqueVario-S VDE provides safety when working with live electrical components. All Wiha TorqueVario-S models have an integrated window scale that displays the torque value - a completely new design, which eliminates false readings. The torque value is continuously adjustable by using the provided adjustment tool (TorqueSetter) this prevents the torque from being altered unintentionally.



Made in Germany

Toll Free: (800) 494-6104

Click image to view web page

Wiha Adjustable TorqueControl Tools

Wiha TorqueControl Screwdrivers

TorqueFix™ & TorqueVario™ ergonomic cushion grip two component handles allow for maximum achievable torque to be reached.

Quality and repeatability - each TorqueFix & TorqueVario tool is tested and complies with:

- EN ISO 6789
- BS EN 26789
- ASME B107.14M

Each tool has unique serial number and certificate of calibration

Whether it's TorqueVario-S, TorqueVario or TorqueFix - Wiha has a torque screwdriver to cover almost every application



Cushion grips for maximum user comfort

Four handle sizes optimized to match torque settings

Audible & perceptible click alerts user that torque level has been attained

Precise torque for service, assembly, tooling & repair

Loosening torque 50% greater than the tightening torque

+/-6% accuracy tolerance



Includes Certificate & Micro Bit Holder 28583

285 TorqueFix, With Wiha-SoftFinish® Handle

Fixed Torque value pre-set. Tested in accordance with EN ISO 6798, BS EN 26789, ASME B107.14M, tolerance +/- 6%. Audible and perceptible click when pre-set torque has been attained. Wiha-SoftFinish® handle, multi-component. 50% greater reverse torque.

| Item No. | Pre-Sets | | Torque | | | | | Each |
|----------|----------|------|--------|-----|------|------|------|---------|
| | oz. | lbs. | Nm | mm | Inch | lbs. | pkg. | |
| 285 03 | 80 | 5 | 0.56 | 112 | 4.4 | .16 | 1 | \$69.98 |
| 285 05 | 120 | 7.5 | 0.84 | 112 | 4.4 | .15 | 1 | \$69.98 |
| 285 07 | 160 | 10 | 1.12 | 119 | 4.7 | .28 | 1 | \$79.98 |
| 285 09 | 200 | 12.5 | 1.41 | 119 | 4.7 | .27 | 1 | \$79.98 |
| 285 11 | 240 | 15 | 1.69 | 119 | 4.7 | .27 | 1 | \$79.98 |
| 285 13 | 320 | 20 | 2.25 | 119 | 4.7 | .28 | 1 | \$79.98 |
| 285 15 | 400 | 25 | 2.82 | 126 | 4.9 | .37 | 1 | \$79.98 |
| 285 17 | 480 | 30 | 3.39 | 126 | 4.9 | .37 | 1 | \$79.98 |
| 285 18 | 560 | 35 | 3.95 | 126 | 4.9 | .37 | 1 | \$89.98 |
| 285 19 | 640 | 40 | 4.52 | 126 | 4.9 | .37 | 1 | \$89.98 |
| 285 21 | 800 | 50 | 5.65 | 132 | 5.2 | .52 | 1 | \$89.98 |
| 285 23 | 960 | 60 | 6.78 | 132 | 5.2 | .52 | 1 | \$89.98 |
| 285 25 | 1120 | 70 | 7.91 | 132 | 5.2 | .52 | 1 | \$89.98 |

285 TorqueVario-S Handle, With Window Scale & 4mm Bit Holder

EN ISO 6798, BS EN 26789, ASME B107.14M. Ergonomic multi-component handle, light and compact. Handle sizes proportioned to optimize torque range. Audible and perceptible click when the torque setting has been attained. Includes Micro Bit Holder 28583

| Item No. | Range | | Torque | | Each | | |
|----------|----------|---------|--------|----------|-----------|---|----------|
| | Inch | lbs. | mm | pkg. | | | |
| 285 01 | 15 - 80 | (in/oz) | 2.5 | Inch oz | 122 - 127 | 1 | \$89.98 |
| 285 02 | 5 - 10 | | .2 | Inch lbs | 122 - 127 | 1 | \$89.98 |
| 285 04 | 7.5 - 20 | | .5 | Inch lbs | 126 - 131 | 1 | \$99.98 |
| 285 06 | 10 - 50 | | 2 | Inch lbs | 133 - 138 | 1 | \$102.98 |
| 285 08 | 20 - 70 | | 2 | Inch lbs | 137 - 142 | 1 | \$109.98 |

See 4mm Micro Bits on Page 127-128



Includes Certificate

285 TorqueVario-S Handle, With Newton Meter Scale

EN ISO 6798, BS EN 26789, ASME B107.14M. Ergonomic multi-component handle, light and compact. Handle sizes proportioned to optimize torque range. Audible and perceptible click when the torque setting has been attained.

| Item No. | Newton | | Torque | | Each |
|----------|-------------|------------|-----------|------|----------|
| | Meter Scale | Increments | mm | pkg. | |
| 285 50 | 0.1 - 0.6Nm | .02 Nm | 122 - 127 | 1 | \$99.98 |
| 285 51 | 0.4 - 1.0Nm | .05 Nm | 122 - 127 | 1 | \$99.98 |
| 285 52 | 0.8 - 2.0Nm | .05 Nm | 126 - 131 | 1 | \$109.98 |
| 285 53 | 1.0 - 5.0Nm | .20 Nm | 133 - 138 | 1 | \$112.98 |
| 285 54 | 2.0 - 8.0Nm | .25 Nm | 137 - 142 | 1 | \$119.98 |



Made in Germany

www.wihatools.com

Click image to view web page

Wiha Adjustable TorqueControl Tool Sets



With Certificate of Calibration

285 90 Set 24 Piece TorqueVario-S Micro-Bit Set

Certified to EN ISO 6798, BS EN 26789, ASME B107.14M. Set includes Ergonomic multi-component Adjustable TorqueVario-S Handle, 21 Micro Bits, Micro Bit Holder and Torque adjustment tool. Packed in a compact durable steel storage box.

| Item No. | | |
|---------------|---|-----------------|
| 285 90 | Slotted: 1.5, 2.0, 3.0, 4.0mm Phillips: #00, #0, #1 | lbs. |
| | Torx: T6, T7, T8, T9, T10, T15 | 1.33 |
| | Hex Inch: .050, 1/16, 5/64, 3/32, 7/64, 1/8, 9/64, 5/32 | Each |
| | 28504 Handle Range 7.5 - 20 Inch lbs. | \$149.98 |



51 Piece Set



With Certificate of Calibration

285 95 Set 51 Piece TorqueVario-S Bit Set In Metal Box

Certified to EN ISO 6798, BS EN 26789, ASME B107.14M. Set includes Ergonomic multi-component Adjustable TorqueVario-S Handle, 48 Insert Bits, 1/4" Bit Holder and Torque adjustment tool.

| Item No. | | |
|---------------|--|-----------------|
| 285 95 | Slotted: 4.5, 5.5, 6.5, 8.0mm | lbs. |
| | Phillips: #0, #1, #2, #3 | 2.85 |
| | Torx: T6, T7, T8, T9, T10, T15, T20, T25 | |
| | Hex Inch: 1/16, 5/64, 3/32, 7/64, 1/8, 9/64, 5/32, 3/16" | |
| | Hex Metric: 1.5, 2.0, 2.5, 3.0, 4.0, 5.0, 6.0, 8.0mm | |
| | Pozidriv: #0, #1, #2, #3 | |
| | Torq Set: #4, #5, #6, #8 | |
| | Square: #1, #2, #3 | |
| | Triwing: #0, #1, #2, #3, #4 | |
| | 28506 Handle Range 10 - 50 Inch lbs. | Each |
| | 28581 1/4" Bit Holder | \$195.98 |

Wiha TorqueControl Adapters

Adapters For TorqueFix™ & TorqueVario™



285 Bit Holder Adapter For 1/4" Drive Bits

Shaft CVM steel, hardened, corrosion protected.

| Item No. | Size | mm | mm | lbs. | pkg. | Each |
|---------------|------|-----|-----|------|------|---------------|
| 285 81 | 1/4 | 149 | 4.0 | .09 | 1 | \$6.98 |

See pages 155-165 for Insert bits



285 Square Drive Adapter For 1/4" Sockets

Shaft CVM steel, hardened, corrosion protected.

| Item No. | Size | mm | mm | lbs. | pkg. | Each |
|---------------|------|-----|-----|------|------|---------------|
| 285 82 | 1/4 | 145 | 4.0 | .08 | 1 | \$6.98 |

See pages 167-169 for Sockets



285 Adapter Blade For Wiha 4 mm MicroBits

Shaft CVM steel, hardened, corrosion protected.

| Item No. | Size | mm | mm | lbs. | pkg. | Each |
|---------------|------|-----|-----|------|------|---------------|
| 285 83 | 4.0 | 149 | 4.0 | .09 | 1 | \$6.98 |

See pages 127-128 for Micro bits



Made in Germany

Toll Free: (800) 494-6104

Click image to view web page

Wiha TorqueControl Blades



285 Slotted Interchangeable Blades For TorqueFix & TorqueVario

Slotted tip blades on narrow 5/32 Hex shafts. High alloy chrome-vanadium-molybdenum steel, hardened, satin hard chrome finish.

| Item | | | | | | |
|--------|-----|------|-----|------|------|--------|
| No. | mm | Inch | mm | lbs. | pkg. | Each |
| 285 34 | 1.5 | .059 | 175 | .07 | 1 | \$4.30 |
| 285 35 | 2.0 | .078 | 175 | .07 | 1 | \$4.30 |
| 285 36 | 2.5 | .098 | 175 | .07 | 1 | \$4.30 |
| 285 37 | 3.0 | .118 | 175 | .07 | 1 | \$4.30 |
| 285 38 | 3.5 | .139 | 175 | .07 | 1 | \$4.30 |
| 285 39 | 4.0 | .157 | 175 | .07 | 1 | \$4.30 |



285 TORX Plus® Blades For TorqueFix & TorqueVario

TORX Plus® tip blades on narrow 5/32 Hex shafts. High alloy chrome-vanadium-molybdenum steel, hardened, satin hard chrome finish.

| Item | | | | | | |
|--------|------|-----|-----|------|------|--------|
| No. | Size | mm | mm | lbs. | pkg. | Each |
| 285 71 | IP5 | 175 | 4.0 | .07 | 1 | \$4.30 |
| 285 72 | IP6 | 175 | 4.0 | .07 | 1 | \$4.30 |
| 285 73 | IP7 | 175 | 4.0 | .07 | 1 | \$4.30 |
| 285 74 | IP8 | 175 | 4.0 | .07 | 1 | \$4.30 |
| 285 75 | IP9 | 175 | 4.0 | .07 | 1 | \$4.30 |
| 285 76 | IP10 | 175 | 4.0 | .07 | 1 | \$4.30 |
| 285 77 | IP15 | 175 | 4.0 | .07 | 1 | \$4.30 |
| 285 78 | IP20 | 175 | 4.0 | .07 | 1 | \$4.30 |
| 285 79 | IP25 | 175 | 4.0 | .07 | 1 | \$4.30 |



285 Phillips Interchangeable Blades For TorqueFix & TorqueVario

Phillips tip blades on narrow 5/32 Hex shafts. High alloy chrome-vanadium-molybdenum steel, hardened, satin hard chrome finish.

| Item | | | | | | |
|--------|-----|-----|-----|------|------|--------|
| No. | mm | mm | mm | lbs. | pkg. | Each |
| 285 40 | 000 | 175 | 4.0 | .07 | 1 | \$4.30 |
| 285 41 | 00 | 175 | 4.0 | .07 | 1 | \$4.30 |
| 285 42 | 0 | 175 | 4.0 | .07 | 1 | \$4.30 |
| 285 43 | 1 | 175 | 4.0 | .07 | 1 | \$4.30 |



285 Hex Metric Interchangeable Blades For TorqueFix & TorqueVario

Slotted tip blades on narrow 5/32 Hex shafts. High alloy CVM steel, hardened, satin hard chrome finish.

| Item | | | | | | |
|--------|-----|-----|------|------|--------|--|
| No. | mm | mm | lbs. | pkg. | Each | |
| 285 45 | 1.5 | 175 | .07 | 1 | \$4.30 | |
| 285 46 | 2.0 | 175 | .07 | 1 | \$4.30 | |
| 285 47 | 2.5 | 175 | .07 | 1 | \$4.30 | |
| 285 48 | 3.0 | 175 | .07 | 1 | \$4.30 | |
| 285 49 | 4.0 | 175 | .07 | 1 | \$4.30 | |



285 TORX® Interchangeable Blades For TorqueFix & TorqueVario

TORX® tip blades on narrow 5/32 Hex shafts. High alloy chrome-vanadium-molybdenum steel, hardened, satin hard chrome finish.

| Item | | | | | | |
|--------|------|-----|-----|------|------|--------|
| No. | Size | mm | mm | lbs. | pkg. | Each |
| 285 61 | T5 | 175 | 4.0 | .07 | 1 | \$4.30 |
| 285 62 | T6 | 175 | 4.0 | .07 | 1 | \$4.30 |
| 285 63 | T7 | 175 | 4.0 | .07 | 1 | \$4.30 |
| 285 64 | T8 | 175 | 4.0 | .07 | 1 | \$4.30 |
| 285 65 | T9 | 175 | 4.0 | .07 | 1 | \$4.30 |
| 285 66 | T10 | 175 | 4.0 | .07 | 1 | \$4.30 |
| 285 67 | T15 | 175 | 4.0 | .07 | 1 | \$4.30 |
| 285 68 | T20 | 175 | 4.0 | .07 | 1 | \$4.30 |
| 285 69 | T25 | 175 | 4.0 | .07 | 1 | \$4.30 |



285 Hex Inch Interchangeable Blades For TorqueFix & TorqueVario

Slotted tip blades on narrow 5/32 Hex shafts. High alloy CVM steel, hardened, satin hard chrome finish.

| Item | | | | | | |
|--------|------|-----|------|------|--------|--|
| No. | Inch | mm | lbs. | pkg. | Each | |
| 285 55 | .050 | 175 | .07 | 1 | \$4.30 | |
| 285 56 | 1/16 | 175 | .07 | 1 | \$4.30 | |
| 285 57 | 5/64 | 175 | .07 | 1 | \$4.30 | |
| 285 58 | 3/32 | 175 | .07 | 1 | \$4.30 | |
| 285 59 | 7/64 | 175 | .07 | 1 | \$4.30 | |
| 285 60 | 1/8 | 175 | .07 | 1 | \$4.30 | |
| 285 87 | 9/64 | 175 | .07 | 1 | \$4.30 | |
| 285 88 | 5/32 | 175 | .07 | 1 | \$4.30 | |

* None of the blades featured on this page will function in a TorqueVario Insulated Handle



Made in Germany

www.wihatools.com

Click image to view web page

Wiha Insulated TorqueControl Tools



1000V

Includes Certificate

285 Insulated TorqueVario-S, With Window Scale Insulation
According to ASTM F-1505-01, New VDE Specification 0682/part 201 and IEC 900, up to 1000 Volt. "GS" Sign. Individually Tested. EN ISO 6798, BS EN 26789, ASME B107.14M, +/- 6% Accuracy
Ergonomic multi-component handle, light and compact. Handle sizes proportioned to optimize torque range. Audible and perceptible click when torque setting has been attained. Includes Certificate

| Item No. | Range | Inch lbs. | Increments | mm | pkg. | Each |
|----------|----------|-------------|------------|----|------|----------|
| 285 14 | 7.5 - 20 | .5 Inch lbs | 126 - 131 | 1 | | \$127.98 |
| 285 16 | 10 - 50 | 2 Inch lbs | 133 - 138 | 1 | | \$131.98 |
| 285 20 | 20 - 70 | 2 Inch lbs | 137 - 142 | 1 | | \$141.98 |

Each TorqueVario handle has unique serial number and certificate of calibration



287 Insulated Slotted Interchangeable Blades For TorqueVario-S
Slotted tip blades on narrow 5/32 Hex shafts. High alloy chrome-vanadium-molybdenum tool steel, hardened.

| Item No. | mm | Inch | mm | lbs. | pkg. | Each |
|----------|-----|------|-----|------|------|--------|
| 287 01 | 3.0 | .118 | 190 | .07 | 1 | \$5.70 |
| 287 03 | 3.5 | .139 | 190 | .07 | 1 | \$5.70 |
| 287 05 | 4.0 | .157 | 190 | .07 | 1 | \$5.70 |
| 287 07 | 5.5 | .216 | 190 | .07 | 1 | \$5.70 |

These Insulated Blades work in Insulated handles only



287 Insulated Phillips Interchangeable Blades For TorqueVario-S
Phillips tip blades on narrow 5/32 Hex shafts. High alloy chrome-vanadium-molybdenum tool steel, hardened.

| Item No. | Size | mm | mm | lbs. | pkg. | Each |
|----------|------|-----|-----|------|------|--------|
| 287 10 | 00 | 190 | 4.0 | .07 | 1 | \$5.70 |
| 287 11 | 0 | 190 | 4.0 | .07 | 1 | \$5.70 |
| 287 12 | 1 | 190 | 4.0 | .07 | 1 | \$5.70 |

These Insulated Blades work in Insulated handles only

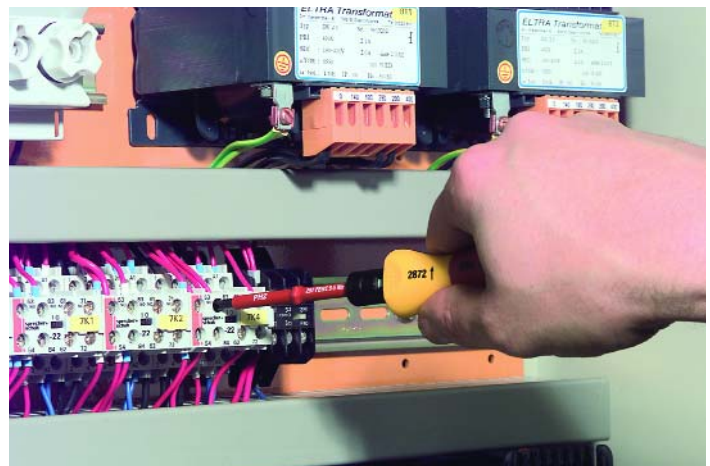

See Insulated Pliers/Cutters & Screwdrivers On Pages 81-91



Made in Germany

Toll Free: (800) 494-6104

Click image to view web page

ESD Safe Adjustable TorqueControl Tools



Includes Certificate

285 ESD Safe TorqueVario-S, With Window Scale

EN ISO 6798, BS EN 26789, ASME B107.14M, +/- 6% Accuracy
Ergonomic multi-component handle, light and compact. Handle sizes proportioned to optimize torque range. Audible and perceptible click when torque setting has been attained. With Certificate of accuracy.

| Item No. | Range | Inch lbs. | Increments | mm | pkg. | Each |
|----------|----------------|-------------|------------|----|----------|------|
| 285 22 | 15 - 80(in/oz) | 2.5 Inch oz | 122 - 127 | 1 | \$110.98 | |
| 285 24 | 5 - 10 | .2 Inch lbs | 122 - 127 | 1 | \$111.98 | |
| 285 26 | 7.5 - 20 | .5 Inch lbs | 126 - 131 | 1 | \$123.98 | |

Each TorqueVario handle has unique serial number and certificate of calibration



With Certificate of Calibration

285 92 Set 24 Pcs. ESD Safe Adjustable TorqueVario-S Bit Set

Certified to EN ISO 6798, BS EN 26789, ASME B107.14M. Set includes Ergonomic multi-component Adjustable TorqueVario-S Handle, 21 Micro Bits, Micro Bit Holder, and Torque adjustment tool, packed in a compact durable steel storage box.

| Item No. | | lbs. | Each |
|----------|---|------|----------|
| 285 92 | Slotted: 1.5, 2.0, 3.0, 4.0mm | | |
| | Phillips: #00, #0, #1 | 1.31 | |
| | Torx: T6, T7, T8, T9, T10, T15 | | |
| | Hex Inch: .050, 1/16, 5/64, 3/32, 7/64, 1/8, 9/64, 5/32 | | |
| 28526 | Handle ESD Safe Range 7.5 - 20 Inch lbs. | | \$164.98 |



288 ESD Safe Slotted Interchangeable Blades For TorqueVario-S

Slotted tip blades on narrow 5/32 Hex shafts. High alloy chrome-vanadium-molybdenum steel, hardened, satin hard chrome finish.

| Item No. | mm | Inch | mm | lbs. | pkg. | Each |
|----------|-----|------|-----|------|------|--------|
| 288 01 | 1.5 | .059 | 175 | .07 | 1 | \$5.20 |
| 288 03 | 2.0 | .078 | 175 | .07 | 1 | \$5.20 |
| 288 05 | 3.0 | .118 | 175 | .07 | 1 | \$5.20 |
| 288 07 | 3.5 | .139 | 175 | .07 | 1 | \$5.20 |
| 288 09 | 4.0 | .157 | 175 | .07 | 1 | \$5.20 |



288 ESD Safe Phillips Interchangeable Blades For TorqueVario-S

Phillips tip blades on narrow 5/32 Hex shafts. High alloy chrome-vanadium-molybdenum steel, hardened, satin hard chrome finish.

| Item No. | Size | mm | mm | lbs. | pkg. | Each |
|----------|------|-----|-----|------|------|--------|
| 288 10 | 000 | 175 | 4.0 | .07 | 1 | \$5.20 |
| 288 12 | 00 | 175 | 4.0 | .07 | 1 | \$5.20 |
| 288 14 | 0 | 175 | 4.0 | .07 | 1 | \$5.20 |
| 288 16 | 1 | 175 | 4.0 | .07 | 1 | \$5.20 |



288 ESD Safe TORX® Interchangeable Blades For TorqueVario-S

TORX® tip blades on narrow 5/32 Hex shafts. High alloy chrome-vanadium-molybdenum steel, hardened, chrome-plated.

| Item No. | Size | mm | mm | lbs. | pkg. | Each |
|----------|------|-----|-----|------|------|--------|
| 288 25 | T5 | 175 | 4.0 | .07 | 1 | \$5.20 |
| 288 26 | T6 | 175 | 4.0 | .07 | 1 | \$5.20 |
| 288 27 | T7 | 175 | 4.0 | .07 | 1 | \$5.20 |
| 288 28 | T8 | 175 | 4.0 | .07 | 1 | \$5.20 |
| 288 29 | T9 | 175 | 4.0 | .07 | 1 | \$5.20 |
| 288 30 | T10 | 175 | 4.0 | .07 | 1 | \$5.20 |



**See ESD Safe Tools
On Pages 68, 76, 104-112, 131-133**



Made in Germany

Toll Free: (800) 494-6104

Click image to view web page

MagicRing Ball End Hex Keys



Ball End Hex Keys
Chamfered ends for easy insertion

Ball End Hex Keys
CVM steel, hardened, chrome-plated, screw holding

ProStar Holder (9-13 pc. Sets)
Sliding front detachable

ProStar Holder
Every key can be taken out separately without having to move another key.

U.S. Patent 6,302,001 B1

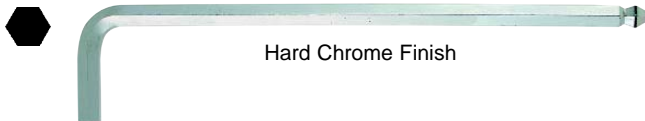

669 MagicRing Ball End Metric Hex L-Key, Long

Blade CVM steel, hardened, chrome-plated.

| Item No. | mm | mm | mm | lbs. | pkg. | Each | |
|------------------|------|-----|----|------|------|--------|---------|
| 669 04* | 1.5 | 89 | 14 | .004 | 10 | \$1.08 | No Ring |
| 669 08* | 2.0 | 99 | 16 | .007 | 10 | \$1.08 | No Ring |
| 669 12* | 2.5 | 111 | 18 | .012 | 10 | \$1.08 | No Ring |
| MagicRing | | | | | | | |
| 669 16 | 3.0 | 125 | 20 | .019 | 10 | \$2.60 | |
| 669 20 | 4.0 | 138 | 25 | .042 | 10 | \$2.66 | |
| 669 24 | 5.0 | 158 | 28 | .072 | 10 | \$2.86 | |
| 669 28 | 6.0 | 178 | 32 | .12 | 10 | \$3.32 | |
| 669 36 | 8.0 | 198 | 36 | .23 | 10 | \$4.68 | |
| 669 44 | 10.0 | 221 | 40 | .40 | 10 | \$6.02 | |

* Standard Ball - No Ring



Hard Chrome Finish

669 90 9 Pc. MagicRing Long Metric Ball End Hex L-Key Set in ProStar Holder

Blade CVM steel, hardened, chrome-plated.

| Item No. | mm | mm | mm | mm | mm | lbs. | Each |
|----------|---------|-----|-----|--------|------|------|---------|
| 669 90 | 669 04* | 1.5 | 89 | 669 24 | 5.0 | 158 | 1.07 |
| | 669 08* | 2.0 | 99 | 669 28 | 6.0 | 178 | |
| | 669 12* | 2.5 | 111 | 669 36 | 8.0 | 198 | |
| | 669 16 | 3.0 | 125 | 669 44 | 10.0 | 221 | Each |
| | 669 20 | 4.0 | 138 | | | | \$26.26 |

* Standard ball - No Ring

Screw Holding Hex Tools!

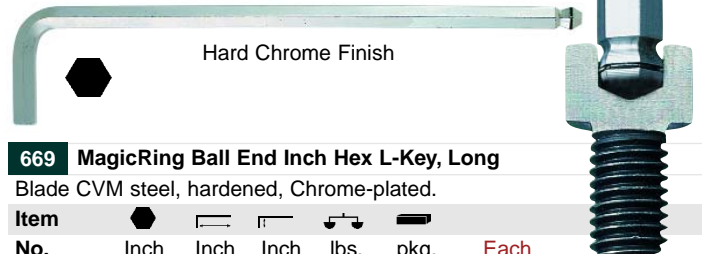

669 MagicRing Ball End Inch Hex L-Key, Long

Blade CVM steel, hardened, Chrome-plated.

| Item No. | Inch | Inch | Inch | lbs. | pkg. | Each | |
|------------------|------|------|------|------|------|--------|---------|
| 669 45* | .050 | 2.78 | .470 | .002 | 10 | \$1.08 | No Ring |
| 669 46* | 1/16 | 3.05 | .549 | .004 | 10 | \$1.08 | No Ring |
| 669 47* | 5/64 | 3.37 | .627 | .007 | 10 | \$1.08 | No Ring |
| 669 50* | 3/32 | 3.84 | .705 | .010 | 10 | \$1.08 | No Ring |
| 669 52* | 7/64 | 3.92 | .784 | .016 | 10 | \$1.08 | No Ring |
| MagicRing | | | | | | | |
| 669 53 | 1/8 | 4.62 | .784 | .021 | 10 | \$2.66 | |
| 669 55 | 9/64 | 5.17 | .901 | .029 | 10 | \$2.66 | |
| 669 56 | 5/32 | 5.64 | .980 | .035 | 10 | \$2.66 | |
| 669 59 | 3/16 | 6.19 | 1.01 | .059 | 10 | \$2.66 | |
| 669 62 | 7/32 | 6.43 | 1.13 | .092 | 10 | \$2.86 | |
| 669 65 | 1/4 | 6.74 | 1.21 | .13 | 10 | \$3.06 | |
| 669 68 | 5/16 | 7.09 | 1.41 | .22 | 10 | \$4.68 | |
| 669 71 | 3/8 | 7.49 | 1.49 | .36 | 10 | \$6.00 | |

* Standard Ball - No Ring



Hard Chrome Finish

669 91 13 Pc. MagicRing Long Inch Ball End Hex L-Key Set in ProStar Holder

Blade CVM steel, hardened, chrome-plated.

| Item No. | Inch | Inch | Inch | Inch | lbs. | Each | |
|----------|---------|------|------|--------|------|------|---------|
| 669 91 | 669 45* | .050 | 2.78 | 669 56 | 5/32 | 5.64 | 1.14 |
| | 669 46* | 1/16 | 3.05 | 669 59 | 3/16 | 6.19 | |
| | 669 47* | 5/64 | 3.37 | 669 62 | 7/32 | 6.43 | |
| | 669 50* | 3/32 | 3.84 | 669 65 | 1/4 | 6.74 | |
| | 669 52* | 7/64 | 3.92 | 669 68 | 5/16 | 7.09 | |
| | 669 53 | 1/8 | 4.62 | 669 71 | 3/8 | 7.49 | Each |
| | 669 55 | 9/64 | 5.17 | | | | \$32.98 |

* Standard Ball - No Ring



669 92 22 Pc. Combination MagicRing L-key Set in ProStar Holder

Blade CVM steel, hardened, chrome-plated.

| Item No. | lbs. | Each |
|----------|---|--------------|
| 669 92 | Set includes: | 2.21 \$53.98 |
| | 66990 Set - 1.5*, 2.0*, 2.5*, 3.0, 4.0, 5.0, 6.0, 8.0, 10.0mm | |
| | 66991 Set - .050*, 1/16*, 5/64*, 3/32*, 7/64*, 1/8, 9/64, 5/32, 3/16, 7/32, 1/4, 5/16, 3/8" | |

* Standard Ball - No Ring



Made in Germany

www.wihatools.com

Click image to view web page

Metric Ball End Hex Keys Black Finish

Ball End Hex Keys
Chamfered ends for easy insertion

Ball End Hex Keys
Working angle up to 30°

Ball End Hex Keys
Chrome-vanadium-molybdenum steel, hardened, black finish

ProStar Holder (9-13 pc. Sets)
Sliding front detachable

ProStar Holder
Every key can be taken out separately without having to move another key.

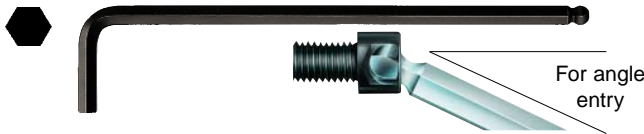

369 Ball End Metric Hex L-Key, Long

Blade CVM steel, hardened, black finish.

| Item | | | | | | Each |
|--------|------|-----|----|------|------|---------|
| No. | mm | mm | mm | lbs. | pkg. | |
| 369 04 | 1.5 | 89 | 14 | .004 | 10 | \$.74 |
| 369 08 | 2.0 | 99 | 16 | .007 | 10 | \$.74 |
| 369 12 | 2.5 | 111 | 18 | .012 | 10 | \$.80 |
| 369 16 | 3.0 | 125 | 20 | .019 | 10 | \$.90 |
| 369 20 | 4.0 | 138 | 25 | .042 | 10 | \$.94 |
| 369 24 | 5.0 | 158 | 28 | .072 | 10 | \$ 1.22 |
| 369 28 | 6.0 | 178 | 32 | .12 | 10 | \$ 1.64 |
| 369 36 | 8.0 | 198 | 36 | .23 | 10 | \$ 2.60 |
| 369 44 | 10.0 | 221 | 40 | .40 | 10 | \$ 3.80 |



369 90 9 Pc. Metric Ball End Long Hex L-Key Set in ProStar Holder

Blade chrome-vanadium-molybdenum steel, hardened, black finish.

| Item | | | | | | |
|--------|--------|-----|-----|--------|------|----------|
| No. | mm | mm | mm | mm | lbs. | |
| 369 90 | 369 04 | 1.5 | 89 | 369 24 | 5.0 | 158 |
| | 369 08 | 2.0 | 99 | 369 28 | 6.0 | 178 |
| | 369 12 | 2.5 | 111 | 369 36 | 8.0 | 198 |
| | 369 16 | 3.0 | 125 | 369 44 | 10.0 | 221 |
| | 369 20 | 4.0 | 138 | | | |
| | | | | | | Each |
| | | | | | | \$ 11.98 |



369 92 Set 6 Pc. Metric Ball End Long Hex L-Key Set

Blade chrome-vanadium-molybdenum steel, hardened, black finish.

| Item | | | | | | |
|--------|--------|-----|------|--------|------|---------|
| No. | Inch | mm | Inch | mm | lbs. | |
| 369 92 | 369 04 | 1.5 | 89 | 369 16 | 3.0 | 125 |
| | 369 08 | 2.0 | 99 | 369 20 | 4.0 | 138 |
| | 369 12 | 2.5 | 111 | 369 24 | 5.0 | 158 |
| | | | | | | Each |
| | | | | | | \$ 6.28 |

Metric Ball End Hex Keys Chrome Finish

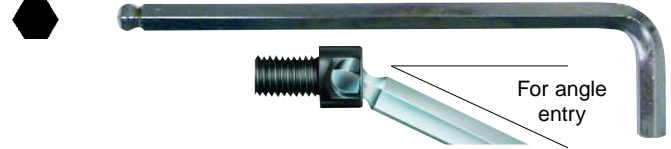

669 Ball End Metric Hex L-Key, Long

Blade CVM steel, hardened, chrome finish.

| Item | | | | | | Each |
|--------|------|-----|----|------|------|---------|
| No. | mm | mm | mm | lbs. | pkg. | |
| 669 04 | 1.5 | 89 | 14 | .004 | 10 | \$ 1.08 |
| 669 08 | 2.0 | 99 | 16 | .007 | 10 | \$ 1.08 |
| 669 12 | 2.5 | 111 | 18 | .012 | 10 | \$ 1.08 |
| 669 18 | 3.0 | 125 | 20 | .019 | 10 | \$ 1.08 |
| 669 22 | 4.0 | 138 | 25 | .042 | 10 | \$ 1.40 |
| 669 26 | 5.0 | 158 | 28 | .072 | 10 | \$ 1.50 |
| 669 30 | 6.0 | 178 | 32 | .12 | 10 | \$ 2.04 |
| 669 37 | 8.0 | 198 | 36 | .23 | 10 | \$ 3.36 |
| 669 38 | 10.0 | 221 | 40 | .40 | 10 | \$ 4.50 |



669 94 9 Pc. Metric Ball End Long Hex L-Key Set

Blade chrome-vanadium-molybdenum steel, hardened, chrome finish.

| Item | | | | | | |
|--------|--------|-----|-----|--------|------|----------|
| No. | mm | mm | mm | mm | lbs. | |
| 669 94 | 669 04 | 1.5 | 89 | 669 26 | 5.0 | 158 |
| | 669 08 | 2.0 | 99 | 669 30 | 6.0 | 178 |
| | 669 12 | 2.5 | 111 | 669 37 | 8.0 | 198 |
| | 669 18 | 3.0 | 125 | 669 38 | 10.0 | 221 |
| | 669 22 | 4.0 | 138 | | | |
| | | | | | | Each |
| | | | | | | \$ 16.58 |



669 95 Set 6 Pc. Metric Ball End Long Hex L-Key Set

Blade chrome-vanadium-molybdenum steel, hardened, chrome finish.

| Item | | | | | | |
|--------|--------|-----|-----|--------|------|---------|
| No. | mm | mm | mm | mm | lbs. | |
| 669 95 | 669 04 | 1.5 | 89 | 669 18 | 3.0 | 125 |
| | 669 08 | 2.0 | 99 | 669 22 | 4.0 | 138 |
| | 669 12 | 2.5 | 111 | 669 26 | 5.0 | 158 |
| | | | | | | Each |
| | | | | | | \$ 7.54 |



Made in Germany

Toll Free: (800) 494-6104

Click image to view web page

Inch Ball End Hex Keys Black Finish

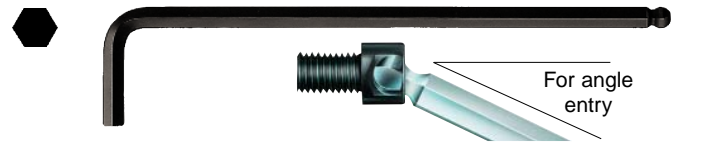

369 Ball End Inch Hex L-Key, Long Arm
Blade CVM steel, hardened, black finish.

| Item No. | Inch | Inch | Inch | lbs. | pkg. | Each |
|----------|------|------|------|------|------|--------|
| 369 45 | .050 | 2.78 | .470 | .002 | 10 | \$.74 |
| 369 46 | 1/16 | 3.05 | .549 | .004 | 10 | \$.74 |
| 369 47 | 5/64 | 3.37 | .629 | .007 | 10 | \$.74 |
| 369 50 | 3/32 | 3.84 | .705 | .010 | 10 | \$.78 |
| 369 52 | 7/64 | 3.92 | .784 | .016 | 10 | \$.88 |
| 369 53 | 1/8 | 4.62 | .784 | .021 | 10 | \$.88 |
| 369 55 | 9/64 | 5.17 | .901 | .029 | 10 | \$.92 |
| 369 56 | 5/32 | 5.64 | .980 | .035 | 10 | \$.96 |
| 369 59 | 3/16 | 6.19 | 1.01 | .059 | 10 | \$1.10 |
| 369 62 | 7/32 | 6.43 | 1.13 | .092 | 10 | \$1.34 |
| 369 65 | 1/4 | 6.74 | 1.21 | .13 | 10 | \$1.54 |
| 369 68 | 5/16 | 7.09 | 1.41 | .22 | 10 | \$2.44 |
| 369 71 | 3/8 | 7.49 | 1.49 | .36 | 10 | \$3.42 |

Inch Ball End Hex Keys Chrome Finish

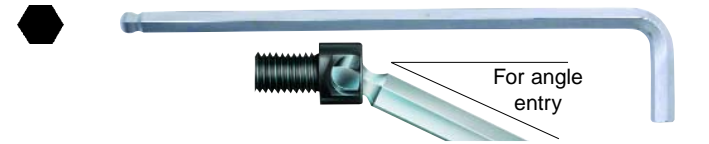

369 Ball End Inch Hex L-Key, Long Arm
Blade CVM steel, hardened, chrome finish.

| Item No. | Inch | Inch | Inch | lbs. | pkg. | Each |
|----------|------|------|------|------|------|--------|
| 369 40 | .050 | 2.78 | .470 | .002 | 10 | \$1.24 |
| 369 41 | 1/16 | 3.05 | .549 | .004 | 10 | \$1.26 |
| 369 42 | 5/64 | 3.37 | .629 | .007 | 10 | \$1.26 |
| 369 43 | 3/32 | 3.84 | .705 | .010 | 10 | \$1.28 |
| 369 48 | 7/64 | 3.92 | .784 | .016 | 10 | \$1.58 |
| 369 49 | 1/8 | 4.62 | .784 | .021 | 10 | \$1.62 |
| 369 51 | 9/64 | 5.17 | .901 | .029 | 10 | \$1.64 |
| 369 54 | 5/32 | 5.64 | .980 | .035 | 10 | \$1.72 |
| 369 57 | 3/16 | 6.19 | 1.01 | .059 | 10 | \$1.88 |
| 369 58 | 7/32 | 6.43 | 1.13 | .092 | 10 | \$2.28 |
| 369 60 | 1/4 | 6.74 | 1.21 | .13 | 10 | \$2.44 |
| 369 61 | 5/16 | 7.09 | 1.41 | .22 | 10 | \$3.20 |
| 369 63 | 3/8 | 7.49 | 1.49 | .36 | 10 | \$4.34 |



369 91 13 Pc. Inch Ball End Long Hex L-Key Set in ProStar Holder
Blade chrome-vanadium-molybdenum steel, hardened, black finish.

| Item No. | Inch | Inch | Inch | Inch | lbs. | Each | |
|----------|--------|------|------|--------|------|------|---------|
| 369 91 | 369 45 | .050 | 2.78 | 369 56 | 5/32 | 5.64 | .99 |
| | 369 46 | 1/16 | 3.05 | 369 59 | 3/16 | 6.19 | |
| | 369 47 | 5/64 | 3.37 | 369 62 | 7/32 | 6.43 | |
| | 369 50 | 3/32 | 3.84 | 369 65 | 1/4 | 6.74 | |
| | 369 52 | 7/64 | 3.92 | 369 68 | 5/16 | 7.09 | |
| | 369 53 | 1/8 | 4.62 | 369 71 | 3/8 | 7.49 | Each |
| | 369 55 | 9/64 | 5.17 | | | | \$14.48 |



369 98 13 Pc. Inch Ball End Long Hex L-Key Set in ProStar Holder
Blade chrome-vanadium-molybdenum steel, hardened, chrome finish.

| Item No. | Inch | Inch | Inch | Inch | lbs. | Each | |
|----------|--------|------|------|--------|------|------|---------|
| 369 98 | 369 40 | .050 | 2.83 | 369 54 | 5/32 | 5.83 | 1.0 |
| | 369 41 | 1/16 | 3.15 | 369 57 | 3/16 | 6.42 | |
| | 369 42 | 5/64 | 3.46 | 369 58 | 7/32 | 6.69 | |
| | 369 43 | 3/32 | 3.98 | 369 60 | 1/4 | 7.01 | |
| | 369 48 | 7/64 | 4.37 | 369 61 | 5/16 | 7.44 | |
| | 369 49 | 1/8 | 4.76 | 369 63 | 3/8 | 7.87 | Each |
| | 369 51 | 9/64 | 5.35 | | | | \$23.98 |



369 93 Set 8 Pc. Inch Ball End Long Hex L-Key Set
Blade chrome-vanadium-molybdenum steel, hardened, black finish.

| Item No. | Inch | mm | Inch | mm | lbs. | Each | |
|----------|--------|------|------|--------|------|------|---------|
| 369 93 | 369 47 | 5/64 | 86 | 369 59 | 3/16 | 158 | .62 |
| | 369 50 | 3/32 | 98 | 369 62 | 7/32 | 164 | |
| | 369 53 | 1/8 | 118 | 369 65 | 1/4 | 172 | Each |
| | 369 56 | 5/32 | 144 | 369 68 | 5/16 | 181 | \$10.48 |



Wiha MagicRing T-handle

Screw Holding Hex Tools

Hole for hanging

Proportioned Ergonomic handle designed for high torque

Handle is molded directly onto blade

Smooth edges prevent injuries & eliminate pressure marks

Blade CVM tool steel, hardened, chrome-plated

540 MagicRing Ball End, With Wiha T-handle Blade CVM steel, hardened, chrome-plated. Ball end for easy insertion. Wiha T-handle high quality plastic, impact resistant.

| Item | | | | | | | | |
|--------|------|-----|-----|-----|------|------|------|--------|
| No. | mm | mm | mm | mm | Inch | lbs. | pkg. | Each |
| 540 40 | 4.0 | 150 | 80 | 176 | 6.9 | .08 | 10 | \$3.10 |
| 540 50 | 5.0 | 150 | 100 | 182 | 7.1 | .14 | 10 | \$3.90 |
| 540 60 | 6.0 | 150 | 100 | 182 | 7.1 | .17 | 10 | \$4.70 |
| 540 80 | 8.0 | 200 | 100 | 232 | 9.1 | .29 | 10 | \$6.20 |
| 540 86 | 10.0 | 200 | 120 | 238 | 9.3 | .49 | 10 | \$8.10 |

540 MagicRing Ball End, With Wiha T-handle Blade CVM steel, hardened, chrome-plated. Ball end for easy insertion. Wiha T-handle high quality plastic, impact resistant.

| Item | | | | | | | | |
|--------|------|------|------|------|------|------|--------|--|
| No. | Inch | Inch | Inch | Inch | lbs. | pkg. | Each | |
| 540 12 | 5/32 | 5.8 | 2.8 | 6.9 | .08 | 10 | \$3.10 | |
| 540 14 | 3/16 | 5.8 | 4.0 | 7.2 | .14 | 10 | \$3.90 | |
| 540 16 | 7/32 | 5.8 | 4.0 | 7.2 | .16 | 10 | \$4.70 | |
| 540 18 | 1/4 | 5.8 | 4.0 | 7.2 | .19 | 10 | \$5.00 | |
| 540 22 | 5/16 | 7.8 | 4.0 | 7.2 | .29 | 10 | \$6.20 | |
| 540 24 | 3/8 | 7.8 | 4.7 | 7.5 | .45 | 10 | \$8.10 | |



540 90 Set 5 Pcs. MagicRing Ball End T-handle Metric Sizes Blade chrome-vanadium-molybdenum steel, hardened, chrome-plated. Wiha T-handle high quality plastic, impact resistant.

| Item | | | | | | | |
|--------|--------|-----|-----|--------|------|------|---------|
| No. | mm | mm | | mm | mm | lbs. | |
| 540 90 | 540 40 | 4.0 | 150 | 540 80 | 8.0 | 200 | 1.49 |
| | 540 50 | 5.0 | 150 | 540 86 | 10.0 | 200 | Each |
| | 540 60 | 6.0 | 150 | | | | \$26.70 |



540 91 Set 6 Pcs. MagicRing Ball End T-handle Inch Sizes Blade chrome-vanadium-molybdenum steel, hardened, chrome-plated. Wiha T-handle high quality plastic, impact resistant.

| Item | | | | | | | |
|--------|--------|------|-----|--------|------|------|---------|
| No. | Inch | Inch | | Inch | Inch | lbs. | |
| 540 91 | 540 12 | 5/32 | 150 | 540 18 | 1/4 | 150 | 1.59 |
| | 540 14 | 3/16 | 150 | 540 22 | 5/16 | 200 | Each |
| | 540 16 | 7/32 | 150 | 540 24 | 3/8 | 200 | \$32.40 |



Toll Free: (800) 494-6104

Click image to view web page

Made in Germany

Wiha Soft ComfortGrip T-handle L-Keys

Two Tools In One!

Through the handle side torque drive

Two component soft grip handle

Ball & Standard Hex In One Powerful Tool

Ball Hex - Blade CVM tool steel, through hardened durability, black finish.

Maximum Comfort & Maximum Power

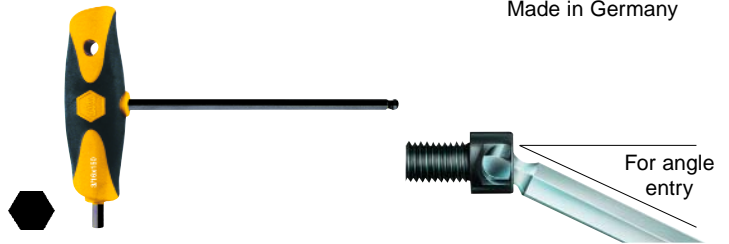
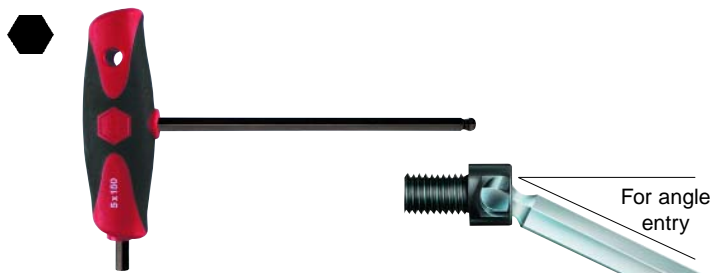

334 ComfortGrip Ball Hex T-handle L-Key CVM steel, hardened, black finish. Ball tip for speed & easy insertion. Wiha soft grips are molded on with through the handle side torque drive.

| Item No. | Hex | Inch | Inch | lbs. | pkg. | Each |
|----------|------|------|------|------|---------|------|
| 334 18* | 5/64 | 5.88 | .84 | 10 | \$3.70 | |
| 334 20* | 3/32 | 5.88 | .88 | 10 | \$3.70 | |
| 334 22* | 7/64 | 5.88 | .96 | 10 | \$3.70 | |
| 334 24* | 1/8 | 5.88 | 1.02 | 10 | \$3.70 | |
| 334 26* | 9/64 | 5.88 | 1.11 | 10 | \$3.70 | |
| 334 28 | 5/32 | 5.88 | 1.11 | 10 | \$3.80 | |
| 334 30 | 3/16 | 5.88 | 2.01 | 10 | \$4.40 | |
| 334 32 | 7/32 | 5.88 | 2.28 | 10 | \$5.00 | |
| 334 33 | 1/4 | 5.88 | 2.57 | 10 | \$5.70 | |
| 334 39 | 5/16 | 7.84 | 4.07 | 10 | \$7.20 | |
| 334 40 | 3/8 | 7.84 | 5.67 | 10 | \$10.00 | |

*No Ball - Standard Hex

334 ComfortGrip Ball End Hex T-handle L-key CVM steel, hardened, black finish. Ball tip for speed & easy insertion. Wiha soft grip are molded on and include through the handle side torque drive.

| Item No. | mm | mm | lbs. | pkg. | Each |
|----------|------|-----|------|------|---------|
| 334 42* | 2.0 | 150 | .85 | 10 | \$3.70 |
| 334 44* | 2.5 | 150 | .92 | 10 | \$3.70 |
| 334 46* | 3.0 | 150 | .99 | 10 | \$3.70 |
| 334 48 | 4.0 | 150 | 1.21 | 10 | \$4.50 |
| 334 50 | 5.0 | 150 | 2.08 | 10 | \$5.40 |
| 334 52 | 6.0 | 150 | 2.44 | 10 | \$5.80 |
| 334 54 | 8.0 | 200 | 3.80 | 10 | \$8.30 |
| 334 58 | 10.0 | 200 | 6.06 | 10 | \$11.10 |

*No Ball - Standard Hex



334 96 Set 8 Pcs. Ball End Hex Metric ComfortGrip T-handle

Blade chrome-vanadium-molybdenum steel, hardened, black oxide. Wiha T-handle high quality plastic, impact resistant.

| Item No. | mm | mm | mm | mm | lbs. | | |
|----------|---------|-----|-----|--------|------|-----|---------|
| 334 96 | 334 42* | 2.0 | 150 | 334 50 | 5.0 | 150 | 2.04 |
| | 334 44* | 2.5 | 150 | 334 52 | 6.0 | 150 | |
| | 334 46* | 3.0 | 150 | 334 54 | 8.0 | 200 | Each |
| | 334 48 | 4.0 | 150 | 334 58 | 10.0 | 200 | \$46.20 |

*No Ball - Standard Hex



334 94 Set 11 Pcs. Ball Hex Inch ComfortGrip T-handle L-Key

Blade chrome-vanadium-molybdenum steel, hardened, black finish. Soft grips are molded on with through the handle side torque drive.

| Item No. | Hex | Inch | Inch | Hex | Inch | Inch | lbs. |
|----------|---------|------|------|--------|------|------|---------|
| 334 94 | 334 18* | 5/64 | 5.88 | 334 30 | 3/16 | 5.88 | 2.39 |
| | 334 20* | 3/32 | 5.88 | 334 32 | 7/32 | 5.88 | |
| | 334 22* | 7/64 | 5.88 | 334 33 | 1/4 | 5.88 | |
| | 334 24* | 1/8 | 5.88 | 334 39 | 5/16 | 7.84 | |
| | 334 26* | 9/64 | 5.88 | 334 40 | 3/8 | 7.84 | Each |
| | 334 28 | 5/32 | 5.88 | | | | \$54.78 |

*No Ball - Standard Hex

334 98 Set 8 Pcs. Ball Hex Inch ComfortGrip T-handle

Blade chrome-vanadium-molybdenum steel, hardened, black finish. Soft grips are molded on with through the handle side torque drive.

| Item No. | Hex | Inch | Inch | Hex | Inch | Inch | lbs. |
|----------|---------|------|------|--------|------|------|---------|
| 334 98 | 334 24* | 1/8 | 5.88 | 334 32 | 7/32 | 5.88 | 2.15 |
| | 334 26* | 9/64 | 5.88 | 334 33 | 1/4 | 5.88 | |
| | 334 28 | 5/32 | 5.88 | 334 39 | 5/16 | 7.84 | Each |
| | 334 30 | 3/16 | 5.88 | 334 40 | 3/8 | 7.84 | \$43.60 |

*No Ball - Standard Hex



Made in Germany

www.wihatools.com

Click image to view web page

Wiha T-handle Hex Tools

Ergonomic handle design for high torque

Hole for hanging



Handle is molded directly onto blade

Smooth edges prevent injuries & eliminate pressure marks

Blade CVM tool steel, hardened, nickel-plated

334 Hex Driver, With Wiha T-handle Blade CVM steel, hardened, nickel-plated. Chamfered tip for easy insertion. Wiha-T-handle high quality plastic, impact resistant.

| Item No. | Inch | Inch | Inch | Inch | lbs. | pkg. | Each |
|----------|------|------|------|------|------|------|--------|
| 334 53 | 3/32 | 6.0 | 2.8 | 7.0 | .05 | 10 | \$2.90 |
| 334 56 | 7/64 | 6.0 | 2.8 | 7.0 | .05 | 10 | \$2.90 |
| 334 59 | 1/8 | 6.0 | 2.8 | 7.0 | .06 | 10 | \$2.90 |
| 334 62 | 9/64 | 6.0 | 2.8 | 7.0 | .07 | 10 | \$2.90 |
| 334 65 | 5/32 | 6.0 | 2.8 | 7.0 | .08 | 10 | \$3.00 |
| 334 68 | 3/16 | 6.0 | 3.5 | 7.0 | .13 | 10 | \$3.40 |
| 334 71 | 7/32 | 6.0 | 3.5 | 7.0 | .16 | 10 | \$3.90 |
| 334 74 | 1/4 | 6.0 | 3.5 | 7.0 | .18 | 10 | \$4.40 |
| 334 77 | 5/16 | 6.0 | 3.5 | 7.0 | .25 | 10 | \$5.50 |
| 334 80 | 3/8 | 6.0 | 4.1 | 7.0 | .39 | 10 | \$7.70 |

| Item No. | mm | mm | mm | mm | Inch | lbs. | pkg. | Each |
|----------|------|-----|-----|-----|------|------|------|---------|
| 334 01 | 2.0 | 100 | 80 | 126 | 4.9 | .05 | 10 | \$2.90 |
| 334 06 | 2.0 | 200 | 80 | 226 | 8.9 | .05 | 10 | \$4.00 |
| 334 02 | 2.5 | 100 | 80 | 126 | 4.9 | .05 | 10 | \$2.90 |
| 334 37 | 2.5 | 200 | 80 | 226 | 8.9 | .08 | 10 | \$4.10 |
| 334 03 | 3.0 | 100 | 80 | 126 | 4.9 | .05 | 10 | \$2.90 |
| 334 04 | 3.0 | 150 | 80 | 176 | 6.9 | .08 | 10 | \$3.40 |
| 334 05 | 3.0 | 200 | 80 | 226 | 8.7 | .09 | 10 | \$3.70 |
| 334 35 | 3.0 | 350 | 100 | 382 | 15.0 | .22 | 10 | \$6.90 |
| 334 06 | 4.0 | 100 | 80 | 126 | 4.9 | .07 | 10 | \$3.00 |
| 334 07 | 4.0 | 150 | 80 | 176 | 6.9 | .10 | 10 | \$3.50 |
| 334 08 | 4.0 | 200 | 80 | 226 | 8.7 | .09 | 10 | \$3.80 |
| 334 38 | 4.0 | 350 | 100 | 382 | 15.0 | .26 | 10 | \$7.60 |
| 334 09 | 5.0 | 100 | 100 | 132 | 5.2 | .13 | 10 | \$3.70 |
| 334 10 | 5.0 | 150 | 100 | 182 | 7.1 | .17 | 10 | \$4.20 |
| 334 11 | 5.0 | 200 | 100 | 232 | 9.1 | .16 | 10 | \$4.10 |
| 334 12 | 5.0 | 350 | 100 | 382 | 15.0 | .26 | 10 | \$7.60 |
| 334 13 | 5.0 | 450 | 120 | 488 | 19.1 | .53 | 10 | \$13.40 |
| 334 14 | 6.0 | 100 | 100 | 132 | 5.2 | .14 | 10 | \$4.40 |
| 334 16 | 6.0 | 200 | 100 | 232 | 9.1 | .20 | 10 | \$4.50 |
| 334 17 | 6.0 | 350 | 100 | 382 | 15.0 | .32 | 10 | \$10.60 |
| 334 21 | 8.0 | 100 | 100 | 132 | 5.2 | .20 | 10 | \$6.00 |
| 334 23 | 8.0 | 200 | 100 | 232 | 9.1 | .29 | 10 | \$6.40 |
| 334 34 | 8.0 | 350 | 100 | 372 | 14.6 | .48 | 10 | \$10.60 |
| 334 25 | 10.0 | 100 | 120 | 138 | 5.4 | .34 | 10 | \$7.90 |
| 334 27 | 10.0 | 200 | 120 | 238 | 9.3 | .49 | 10 | \$8.50 |

Yellow = Inch
Red = Metric



334 93 Set 8 Pc. Hex Driver T-handle Metric Sizes

Blade chrome-vanadium-molybdenum steel, hardened, nickel-plated. Wiha T-handle high quality plastic, impact resistant.

| Item No. | mm | mm | mm | mm | mm | lbs. | |
|----------|--------|-----|-----|--------|------|------|---------|
| 334 93 | 334 01 | 2.0 | 100 | 334 09 | 5.0 | 100 | 1.64 |
| | 334 02 | 2.5 | 100 | 334 16 | 6.0 | 200 | |
| | 334 03 | 3.0 | 100 | 334 23 | 8.0 | 200 | Each |
| | 334 06 | 4.0 | 100 | 334 27 | 10.0 | 200 | \$34.68 |



334 92 Set 10 Pc. Hex Driver T-handle Inch Sizes

Blade chrome-vanadium-molybdenum steel, hardened, nickel-plated. Wiha T-handle high quality plastic, impact resistant.

| Item No. | Inch | Inch | Inch | Inch | lbs. | | |
|----------|--------|------|------|--------|------|-----|---------|
| 334 92 | 334 53 | 3/32 | 6.0 | 334 68 | 3/16 | 6.0 | 1.74 |
| | 334 56 | 7/64 | 6.0 | 334 71 | 7/32 | 6.0 | |
| | 334 59 | 1/8 | 6.0 | 334 74 | 1/4 | 6.0 | |
| | 334 62 | 9/64 | 6.0 | 334 77 | 5/16 | 6.0 | Each |
| | 334 65 | 5/32 | 6.0 | 334 80 | 3/8 | 6.0 | \$39.28 |





Made in Germany

Toll Free: (800) 494-6104

Click image to view web page

Wiha MagicRing SoftFinish® Hex Drivers

Screw Holding Hex Tools



Screw Holding

367 91 13 Pc. Set MagicRing Inch Ball End Screwdrivers

Hex blade chrome-vanadium-molybdenum steel, hardened, chrome-plated. Wiha-SoftFinish® handle, multi-component, cushion grip.

| Item No. | Hex | Inch | Inch | Hex | Inch | Inch | lbs. |
|----------|---------|------|------|--------|------|------|---------|
| 367 91 | 367 10* | .050 | 3.0 | 367 32 | 5/32 | 5.0 | 2.58 |
| | 367 13* | 1/16 | 3.0 | 367 34 | 3/16 | 6.0 | |
| | 367 16* | 5/64 | 4.0 | 367 36 | 7/32 | 6.0 | |
| | 367 19* | 3/32 | 4.0 | 367 38 | 1/4 | 6.0 | |
| | 367 23* | 7/64 | 4.0 | 367 42 | 5/16 | 8.0 | |
| | 367 26 | 1/8 | 4.0 | 367 44 | 3/8 | 8.0 | Each |
| | 367 28 | 9/64 | 4.0 | | | | \$56.40 |

* Standard Ball - No Ring

367 MagicRing Ball End Hex-Driver Metric, With Wiha-SoftFinish®

Handle Hex blade, high alloy CVM steel, hardened, chrome-plated. Wiha-SoftFinish® handle, multi-component, cushion grip.

| Item No. | Hex | mm | mm | mm | lbs. | pkg. | Each |
|-----------------------|------|-----|-----|-----|------|--------|------|
| 367 15* | 1.5 | 75 | 179 | .06 | 10 | \$3.30 | |
| 367 20* | 2.0 | 100 | 204 | .07 | 10 | \$3.30 | |
| 367 25* | 2.5 | 100 | 204 | .07 | 10 | \$3.30 | |
| With MagicRing | | | | | | | |
| 367 30 | 3.0 | 100 | 204 | .07 | 10 | \$4.10 | |
| 367 40 | 4.0 | 125 | 211 | .12 | 10 | \$4.30 | |
| 367 50 | 5.0 | 150 | 243 | .16 | 10 | \$4.40 | |
| 367 60 | 6.0 | 150 | 243 | .23 | 10 | \$5.00 | |
| 367 80 | 8.0 | 200 | 268 | .37 | 10 | \$6.20 | |
| 367 86 | 10.0 | 200 | 271 | .54 | 10 | \$8.00 | |

* Standard Ball - No Ring

367 MagicRing Ball End Hex-Driver Inch, With Wiha-SoftFinish®

Handle Hex blade, high alloy CVM steel, hardened, chrome-plated. Wiha-SoftFinish® handle, multi-component, cushion grip.

| Item No. | Hex | mm | mm | mm | lbs. | pkg. | Each |
|-----------------------|------|-----|-----|-----|------|--------|------|
| 367 10* | .050 | 80 | 179 | .06 | 10 | \$3.30 | |
| 367 13* | 1/16 | 80 | 204 | .06 | 10 | \$3.20 | |
| 367 16* | 5/64 | 100 | 204 | .07 | 10 | \$3.10 | |
| 367 19* | 3/32 | 100 | 204 | .07 | 10 | \$3.10 | |
| 367 23* | 7/64 | 100 | 211 | .07 | 10 | \$3.20 | |
| With MagicRing | | | | | | | |
| 367 26 | 1/8 | 100 | 243 | .12 | 10 | \$4.10 | |
| 367 28 | 9/64 | 100 | 243 | .12 | 10 | \$4.20 | |
| 367 32 | 5/32 | 125 | 271 | .12 | 10 | \$4.20 | |
| 367 34 | 3/16 | 150 | 271 | .16 | 10 | \$4.30 | |
| 367 36 | 7/32 | 150 | 271 | .23 | 10 | \$4.70 | |
| 367 38 | 1/4 | 150 | 271 | .25 | 10 | \$5.20 | |
| 367 42 | 5/16 | 200 | 271 | .37 | 10 | \$6.20 | |
| 367 44 | 3/8 | 200 | 271 | .54 | 10 | \$8.00 | |

* Standard Ball - No Ring



Screw Holding

367 93 8 Pc. Set MagicRing Inch Ball End Screwdrivers

Hex blade chrome-vanadium-molybdenum steel, hardened, chrome-plated. Wiha-SoftFinish® handle, multi-component, cushion grip.

| Item No. | Hex | Inch | Inch | Hex | Inch | Inch | lbs. |
|----------|--------|------|------|--------|------|------|---------|
| 367 93 | 367 26 | 1/8 | 4.0 | 367 36 | 7/32 | 6.0 | 2.25 |
| | 367 28 | 9/64 | 4.0 | 367 38 | 1/4 | 6.0 | |
| | 367 32 | 5/32 | 5.0 | 367 42 | 5/16 | 8.0 | Each |
| | 367 34 | 3/16 | 6.0 | 367 44 | 3/8 | 8.0 | \$41.70 |



Screw Holding

367 94 6 Pc. Set MagicRing Inch Ball End Screwdrivers

Hex blade chrome-vanadium-molybdenum steel, hardened, chrome-plated. Wiha-SoftFinish® handle, multi-component, cushion grip.

| Item No. | Hex | Inch | Inch | Hex | Inch | Inch | lbs. |
|----------|--------|------|------|--------|------|------|---------|
| 367 94 | 367 26 | 1/8 | 4.0 | 367 34 | 3/16 | 6.0 | 1.26 |
| | 367 28 | 9/64 | 4.0 | 367 36 | 7/32 | 6.0 | Each |
| | 367 32 | 5/32 | 5.0 | 367 38 | 1/4 | 6.0 | \$27.60 |



Made in Germany

www.wihatools.com

Click image to view web page

Wiha MagicRing SoftFinish® Hex Drivers



Screw Holding Hex Tools

367 90 9 Pc. Set MagicRing Metric Ball End Hex-Drivers

Hex blade chrome-vanadium-molybdenum steel, hardened, chrome-plated. Wiha-SoftFinish® handle, multi-component, cushion grip.

| Item No. | mm | mm | mm | mm | lbs. |
|----------|---------|-----|-----|--------|--------------|
| 367 90 | 367 15* | 1.5 | 75 | 367 50 | 5.0 150 2.06 |
| | 367 20* | 2.0 | 100 | 367 60 | 6.0 150 |
| | 367 25* | 2.5 | 100 | 367 80 | 8.0 200 |
| | 367 30 | 3.0 | 100 | 367 86 | 10.0 200 |
| | 367 40 | 4.0 | 125 | | Each \$40.78 |

* Standard Ball - No Ring



Screw Holding Hex Tools

367 92 6 Pc. Set MagicRing Metric Ball End Hex-Drivers

Hex blade chrome-vanadium-molybdenum steel, hardened, chrome-plated. Wiha-SoftFinish® handle, multi-component, cushion grip.

| Item No. | mm | mm | mm | mm | lbs. |
|----------|--------|-----|-----|--------|--------------|
| 367 92 | 367 30 | 3.0 | 100 | 367 60 | 6.0 150 1.86 |
| | 367 40 | 4.0 | 125 | 367 80 | 8.0 200 |
| | 367 50 | 5.0 | 150 | 367 86 | 10.0 200 |

Each \$32.10



Screw Holding Hex Tools

367 95 4 Pc. Set MagicRing Metric Ball End Hex-Drivers

Hex blade chrome-vanadium-molybdenum steel, hardened, chrome-plated. Wiha-SoftFinish® handle, multi-component, cushion grip.

| Item No. | mm | mm | mm | mm | lbs. |
|----------|--------|-----|-----|--------|-------------|
| 367 95 | 367 30 | 3.0 | 100 | 367 50 | 5.0 150 .84 |
| | 367 40 | 4.0 | 125 | 367 60 | 6.0 150 |

Each \$18.80

Wiha MagicRing PocketStar Fold-Ups



Screw Holding

369 9 Pc. MagicRing Inch PocketStar Fold Outs

High alloy CVM steel, hardened, molded ergonomic handle.

| Item No | Each |
|-------------------|-------------|
| 369 97 PocketStar | .46 \$18.96 |

Inch: 5/64*, 3/32*, 7/64*, 1/8, 9/64, 5/32, 3/16, 7/32, 1/4"

* Standard Ball - No Ring



Screw Holding

369 7 Pc. MagicRing Metric PocketStar Fold Outs

High alloy CVM steel, hardened, molded ergonomic handle.

| Item No | Each |
|-------------------|-------------|
| 369 96 PocketStar | .50 \$18.96 |

Metric: 2.0*, 2.5*, 3.0, 4.0, 5.0, 6.0, 8.0mm

* Standard Ball - No Ring



Made in Germany

Toll Free: (800) 494-6104

Click image to view web page

Wiha Ball End 3K Series Drivers & Sets

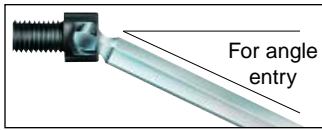

For angle entry



Inch / Soft Grip

467 Ball End Hex Inch Drivers, With 3K Ergo Soft Grip Handles

Blades of CVM special steel, hardened, black finish. Molded on Wiha-3K Ergo soft grip handles.

| Item No. | Inch | Inch | Inch | pkg. | Each |
|----------|------|------|------|------|--------|
| 467 02 | .050 | 2.9 | 6.3 | 10 | \$2.60 |
| 467 04 | 1/16 | 2.9 | 6.3 | 10 | \$2.60 |
| 467 06 | 5/64 | 3.9 | 7.3 | 10 | \$2.60 |
| 467 08 | 3/32 | 3.9 | 7.3 | 10 | \$2.60 |
| 467 10 | 7/64 | 3.9 | 7.3 | 10 | \$2.60 |
| 467 12 | 1/8 | 3.9 | 7.7 | 10 | \$3.10 |
| 467 14 | 9/64 | 3.9 | 7.7 | 10 | \$3.10 |
| 467 16 | 5/32 | 3.9 | 7.7 | 10 | \$3.10 |
| 467 18 | 3/16 | 2.9 | 7.7 | 10 | \$3.10 |
| 467 22 | 7/32 | 5.9 | 10.0 | 10 | \$4.10 |
| 467 24 | 1/4 | 5.9 | 10.0 | 10 | \$4.10 |
| 467 26 | 5/16 | 7.9 | 12.0 | 10 | \$5.10 |
| 467 28 | 3/8 | 7.9 | 12.5 | 10 | \$6.70 |

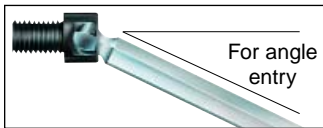

For angle entry



Metric / Soft Grip

467 Ball End Hex Metric Screwdriver, With Wiha-3K Ergo Handle

Blades of CVM special steel, hardened, black finish. Molded on Wiha-3K Ergo soft grip handles.

| Item No. | mm | mm | mm | pkg. | Each |
|----------|------|-----|-----|------|--------|
| 467 15 | 1.5 | 75 | 161 | 10 | \$2.60 |
| 467 20 | 2.0 | 100 | 186 | 10 | \$2.60 |
| 467 25 | 2.5 | 100 | 186 | 10 | \$2.60 |
| 467 30 | 3.0 | 100 | 186 | 10 | \$3.10 |
| 467 40 | 4.0 | 100 | 197 | 10 | \$3.10 |
| 467 50 | 5.0 | 100 | 197 | 10 | \$3.10 |
| 467 60 | 6.0 | 150 | 257 | 10 | \$4.10 |
| 467 80 | 8.0 | 200 | 307 | 10 | \$5.10 |
| 467 86 | 10.0 | 200 | 319 | 10 | \$6.70 |

Yellow = Inch
Red = Metric

See 3K Ergonomic Series
Screwdrivers On Pages 72-73

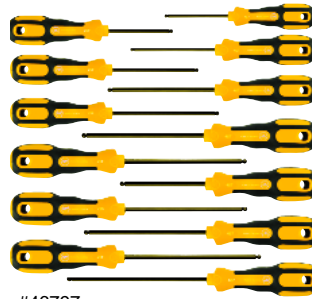

#46797

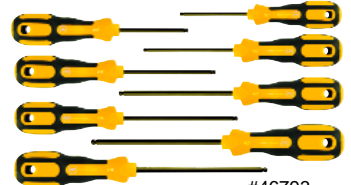

#46793

467 97 Set 13 Pcs. Inch Ball End Hex Drivers

Blades of CVM special steel, hardened, black finish. Molded on Wiha-3k Ergo soft grip handles.

| Item No. | Inch | mm | Size | mm | lbs. | |
|----------|--------|------|------|--------|----------|---------|
| 467 97 | 467 02 | .050 | 2.9 | 467 16 | 5/32 3.9 | 2.49 |
| | 467 04 | 1/16 | 2.9 | 467 18 | 3/16 2.9 | |
| | 467 06 | 5/64 | 3.9 | 467 22 | 7/32 5.9 | |
| | 467 08 | 3/32 | 3.9 | 467 24 | 1/4 5.9 | |
| | 467 10 | 7/64 | 3.9 | 467 26 | 5/16 7.9 | |
| | 467 12 | 1/8 | 3.9 | 467 28 | 3/8 7.9 | Each |
| | 467 14 | 9/64 | 3.9 | | | \$44.80 |

467 93 Set 8 Pcs. Inch Ball End Hex Drivers

Blades of CVM special steel, hardened, black finish. Molded on Wiha-3k Ergo soft grip handles.

| Item No. | Inch | mm | Size | mm | lbs. | |
|----------|--------|------|------|--------|----------|---------|
| 467 93 | 467 02 | .050 | 2.9 | 467 10 | 7/64 3.9 | 1.19 |
| | 467 04 | 1/16 | 2.9 | 467 12 | 1/8 3.9 | |
| | 467 06 | 5/64 | 3.9 | 467 14 | 9/64 3.9 | Price |
| | 467 08 | 3/32 | 3.9 | 467 16 | 5/32 3.9 | \$22.98 |

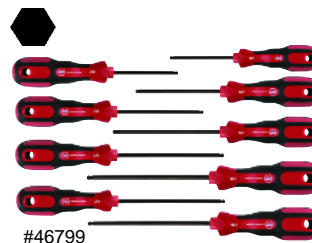

#46799

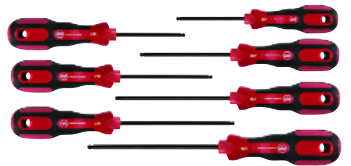

#46796

467 99 Set 9 Pcs. Metric Ball End Hex Drivers

Blades of CVM special steel, hardened, black finish. Molded on Wiha-3k Ergo soft grip handles.

| Item No. | mm | mm | Size | mm | lbs. | |
|----------|--------|-----|------|--------|----------|---------|
| 467 99 | 467 15 | 1.5 | 75 | 467 50 | 5.0 100 | 2.04 |
| | 467 20 | 2.0 | 100 | 467 60 | 6.0 150 | |
| | 467 25 | 2.5 | 100 | 467 80 | 8.0 200 | |
| | 467 30 | 3.0 | 100 | 467 86 | 10.0 200 | Price |
| | 467 40 | 4.0 | 100 | | | \$33.68 |

467 96 Set 7 Pcs. Metric Ball End Hex Drivers

Blades of CVM special steel, hardened, black finish. Molded on Wiha-3k Ergo soft grip handles.

| Item No. | mm | mm | Size | mm | lbs. | |
|----------|--------|-----|------|--------|---------|---------|
| 467 96 | 467 15 | 1.5 | 75 | 467 40 | 4.0 100 | 1.15 |
| | 467 20 | 2.0 | 100 | 467 50 | 5.0 100 | |
| | 467 25 | 2.5 | 100 | 467 60 | 6.0 150 | Price |
| | 467 30 | 3.0 | 100 | | | \$20.98 |



Made in Germany

www.wihatools.com

Click image to view web page

Nickel-Plated Long Arm Hex L-keys



• Ideal for use in clean rooms & other environments where non-oxidizing surfaces are specified or required.

Nickel-Plated

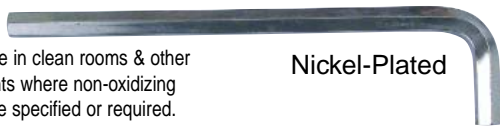

352 Metric L-wrench Hex Key, Long Arm, high alloy CVM steel, hardened, nickel plated. Precision machined, burr free chamfered ends.

| Item | Hex | mm | Inch | mm | Inch | pkg. | Each |
|--------|------|-----|-------|----|------|------|----------|
| 352 01 | 1.5 | 91 | 3.58 | 15 | .58 | 10 | \$.32 |
| 352 02 | 2.0 | 101 | 3.98 | 18 | .70 | 10 | \$.38 |
| 352 04 | 2.5 | 113 | 4.45 | 20 | .78 | 10 | \$.52 |
| 352 06 | 3.0 | 128 | 5.04 | 23 | .90 | 10 | \$.72 |
| 352 08 | 4.0 | 142 | 5.59 | 29 | 1.13 | 10 | \$.82 |
| 352 10 | 5.0 | 163 | 6.42 | 33 | 1.29 | 10 | \$.96 |
| 352 11 | 6.0 | 184 | 7.24 | 38 | 1.49 | 10 | \$ 1.20 |
| 352 12 | 7.0 | 194 | 7.64 | 41 | 1.60 | 10 | \$ 2.22 |
| 352 14 | 8.0 | 206 | 8.11 | 44 | 1.72 | 10 | \$ 2.34 |
| 352 17 | 10.0 | 231 | 9.09 | 50 | 1.96 | 10 | \$ 3.62 |
| 352 19 | 12.0 | 259 | 10.20 | 57 | 2.23 | 1 | \$ 5.95 |
| 352 21 | 14.0 | 291 | 11.46 | 70 | 2.74 | 1 | \$ 8.68 |
| 352 23 | 17.0 | 333 | 13.11 | 80 | 3.13 | 1 | \$ 13.14 |
| 352 27 | 19.0 | 375 | 14.76 | 89 | 3.49 | 1 | \$ 17.54 |

352 Inch L-wrench Hex Key, Long Arm

| Item | Hex | mm | Inch | pkg. | Each |
|--------|------|-----|------|------|----------|
| 352 31 | .050 | 73 | 2.87 | 10 | \$.32 |
| 352 33 | 1/16 | 80 | 3.15 | 10 | \$.32 |
| 352 35 | 5/64 | 88 | 3.46 | 10 | \$.38 |
| 352 37 | 3/32 | 101 | 3.98 | 10 | \$.46 |
| 352 39 | 7/64 | 111 | 4.37 | 10 | \$.92 |
| 352 41 | 1/8 | 121 | 4.76 | 10 | \$.92 |
| 352 43 | 9/64 | 136 | 5.35 | 10 | \$.76 |
| 352 51 | 5/32 | 148 | 5.83 | 10 | \$.76 |
| 352 52 | 3/16 | 163 | 6.42 | 10 | \$.96 |
| 352 53 | 7/32 | 170 | 6.69 | 10 | \$ 1.16 |
| 352 54 | 1/4 | 178 | 7.01 | 10 | \$ 1.26 |
| 352 55 | 5/16 | 189 | 7.44 | 10 | \$ 2.10 |
| 352 56 | 3/8 | 200 | 7.87 | 10 | \$ 3.06 |
| 352 57 | 1/2 | - | - | 1 | \$ 6.92 |
| 352 58 | 9/16 | - | - | 1 | \$ 9.16 |
| 352 59 | 5/8 | - | - | 1 | \$ 10.98 |
| 352 61 | 3/4 | - | - | 1 | \$ 20.76 |



352 97 Metric Hex L-wrench Set,

9 Pc. in Plastic Holder

Equipped with 1.5, 2.0, 2.5, 3.0, 4.0, 5.0, 6.0, 8.0, 10.0mm

pkg. 1 Each \$16.98



352 95 Inch Hex L-wrench Set,

13 Pc. in Plastic Holder

Equipped with .050, 1/16, 5/64, 3/32, 7/64, 1/8, 9/64, 5/32, 3/16, 7/32, 1/4, 5/16, 3/8"

pkg. 1 Each \$13.98

Black Finish Long Arm Hex L-keys



• Ideal for use in clean rooms & other environments where non-oxidizing surfaces are specified or required.

Black Finish

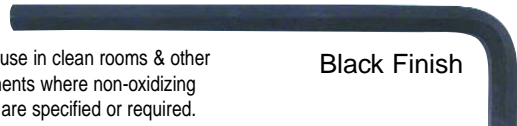

352 Metric L-wrench Hex Key, Long Arm, high alloy CVM steel, hardened, black finish. Precision machined, burr free chamfered ends.

| Item | Hex | mm | Inch | mm | Inch | pkg. | Each |
|--------|------|-----|-------|----|------|------|----------|
| 352 05 | 1.3 | 80 | 3.15 | 13 | .51 | 10 | \$.28 |
| 352 15 | 1.5 | 91 | 3.58 | 15 | .58 | 10 | \$.32 |
| 352 20 | 2.0 | 101 | 3.98 | 18 | .70 | 10 | \$.40 |
| 352 25 | 2.5 | 113 | 4.45 | 20 | .78 | 10 | \$.48 |
| 352 30 | 3.0 | 128 | 5.04 | 23 | .90 | 10 | \$.68 |
| 352 40 | 4.0 | 142 | 5.59 | 29 | 1.13 | 10 | \$.88 |
| 352 50 | 5.0 | 163 | 6.42 | 33 | 1.29 | 10 | \$ 1.02 |
| 352 60 | 6.0 | 184 | 7.24 | 38 | 1.49 | 10 | \$ 1.24 |
| 352 70 | 7.0 | 194 | 7.64 | 41 | 1.60 | 10 | \$ 1.76 |
| 352 80 | 8.0 | 206 | 8.11 | 44 | 1.72 | 10 | \$ 2.42 |
| 352 82 | 10.0 | 231 | 9.09 | 50 | 1.96 | 10 | \$ 3.10 |
| 352 84 | 12.0 | 259 | 10.20 | 57 | 2.23 | 1 | \$ 5.20 |
| 352 85 | 14.0 | 291 | 11.46 | 70 | 2.74 | 1 | \$ 5.48 |
| 352 86 | 17.0 | 333 | 13.11 | 80 | 3.13 | 1 | \$ 12.54 |
| 352 88 | 19.0 | 375 | 14.76 | 89 | 3.49 | 1 | \$ 17.36 |

352 Inch L-wrench Hex Key, Long Arm

| Item | Hex | mm | Inch | pkg. | Each |
|--------|------|-----|------|------|----------|
| 352 14 | .050 | 73 | 2.87 | 10 | \$.34 |
| 352 16 | 1/16 | 80 | 3.15 | 10 | \$.34 |
| 352 18 | 5/64 | 88 | 3.46 | 10 | \$.40 |
| 352 22 | 3/32 | 101 | 3.98 | 10 | \$.46 |
| 352 24 | 7/64 | 111 | 4.37 | 10 | \$.90 |
| 352 26 | 1/8 | 121 | 4.76 | 10 | \$.86 |
| 352 28 | 9/64 | 136 | 5.35 | 10 | \$.76 |
| 352 32 | 5/32 | 148 | 5.83 | 10 | \$.76 |
| 352 34 | 3/16 | 163 | 6.42 | 10 | \$.94 |
| 352 36 | 7/32 | 170 | 6.69 | 10 | \$ 1.15 |
| 352 38 | 1/4 | 178 | 7.01 | 10 | \$ 1.24 |
| 352 42 | 5/16 | 189 | 7.44 | 10 | \$ 2.04 |
| 352 44 | 3/8 | 200 | 7.87 | 10 | \$ 2.96 |
| 352 45 | 1/2 | - | - | 1 | \$ 6.84 |
| 352 46 | 9/16 | - | - | 1 | \$ 9.10 |
| 352 47 | 5/8 | - | - | 1 | \$ 10.90 |
| 352 48 | 3/4 | - | - | 1 | \$ 20.58 |
| 352 49 | 1" | - | - | 1 | \$ 43.86 |



352 90 Metric Hex L-wrench Set,

9 Pc. in Plastic Holder

Equipped with 1.5, 2.0, 2.5, 3.0, 4.0, 5.0, 6.0, 8.0, 10.0mm

pkg. 1 Each \$12.98



352 91 Inch Hex L-wrench Set,

13 Pc. in Plastic Holder

Equipped with .050, 1/16, 5/64, 3/32, 7/64, 1/8, 9/64, 5/32, 3/16, 7/32, 1/4, 5/16, 3/8"

pkg. 1 Each \$14.48



Made in Germany

Toll Free: (800) 494-6104

Click image to view web page

Short Arm Hex L-keys Nickel Finish



• Ideal for use in clean rooms & other environments where non-oxidizing surfaces are specified or required.



Nickel-Plated

351 Metric L-wrench Hex Key, Short Arm, high alloy CVM steel, hardened, nickel plated. Precision machined, burr free chamfered ends.

| Item No. | Size | mm | Inch | mm | Inch | pkg. | Each |
|----------|------|-----|------|----|------|------|---------|
| 351 04 | 1.5 | 46 | 1.8 | 15 | .58 | 10 | \$.27 |
| 351 08 | 2.0 | 51 | 2.0 | 18 | .70 | 10 | \$.27 |
| 351 12 | 2.5 | 57 | 2.2 | 20 | .78 | 10 | \$.30 |
| 351 16 | 3.0 | 64 | 2.5 | 23 | .90 | 10 | \$.34 |
| 351 20 | 4.0 | 72 | 2.8 | 29 | 1.13 | 10 | \$.37 |
| 351 24 | 5.0 | 83 | 3.2 | 33 | 1.29 | 10 | \$.51 |
| 351 28 | 6.0 | 94 | 3.7 | 38 | 1.49 | 10 | \$.62 |
| 351 32 | 7.0 | 99 | 3.9 | 41 | 1.60 | 10 | \$.80 |
| 351 36 | 8.0 | 105 | 4.1 | 44 | 1.72 | 10 | \$ 1.08 |
| 351 40 | 9.0 | 112 | 4.4 | 47 | 1.84 | 10 | \$ 1.48 |
| 351 44 | 10.0 | 119 | 4.7 | 50 | 1.96 | 10 | \$ 1.66 |
| 351 45 | 12.0 | 134 | 5.0 | 57 | 2.23 | 10 | \$ 2.52 |
| 351 75 | 14.0 | 151 | 5.9 | 70 | 2.74 | 1 | \$ 4.28 |
| 351 77 | 17.0 | 173 | 6.8 | 80 | 3.13 | 1 | \$ 7.18 |
| 351 79 | 19.0 | 195 | 7.7 | 89 | 3.49 | 1 | \$ 9.42 |

351 Inch L-wrench Hex Key, Short Arm Nickel-plated

| Item No. | Size | mm | Inch | mm | Inch | pkg. | Each |
|----------|------|-----|------|----|------|------|----------|
| 351 43 | .050 | 40 | 1.6 | 10 | .39 | 10 | \$.27 |
| 351 46 | 1/16 | 46 | 1.8 | 16 | .63 | 10 | \$.27 |
| 351 47 | 5/64 | 50 | 2.0 | 16 | .63 | 10 | \$.30 |
| 351 50 | 3/32 | 52 | 2.1 | 19 | .75 | 10 | \$.34 |
| 351 52 | 7/64 | 54 | 2.1 | 19 | .75 | 10 | \$.37 |
| 351 53 | 1/8 | 58 | 2.3 | 21 | .83 | 10 | \$.37 |
| 351 55 | 9/64 | 62 | 2.4 | 23 | .91 | 10 | \$.41 |
| 351 56 | 5/32 | 68 | 2.7 | 25 | .99 | 10 | \$.44 |
| 351 59 | 3/16 | 70 | 2.8 | 26 | 1.0 | 10 | \$.58 |
| 351 62 | 7/32 | 77 | 3.1 | 29 | 1.2 | 10 | \$.66 |
| 351 65 | 1/4 | 88 | 3.5 | 31 | 1.2 | 10 | \$.76 |
| 351 68 | 5/16 | 98 | 3.9 | 36 | 1.4 | 10 | \$ 1.34 |
| 351 71 | 3/8 | 107 | 4.2 | 38 | 1.5 | 10 | \$ 2.12 |
| 351 74 | 1/2 | 133 | 5.2 | 44 | 1.7 | 1 | \$ 4.14 |
| 351 76 | 9/16 | 158 | 6.2 | 64 | 2.5 | 1 | \$ 4.52 |
| 351 78 | 5/8 | 175 | 6.9 | 71 | 2.8 | 1 | \$ 7.60 |
| 351 80 | 3/4 | 198 | 7.8 | 89 | 3.5 | 1 | \$ 11.48 |



351 91 Metric Hex L-wrench Set, 9 Pc. in Plastic Holder

Equipped with 1.5, 2.0, 2.5, 3.0, 4.0, 5.0, 6.0, 8.0, 10.0mm
 lbs. .59 pkg. 1 Each \$7.98



351 92 Inch Hex L-wrench Set, 8 Pc. in Plastic Holder

Equipped with 5/64, 3/32, 1/8, 5/32, 3/16, 7/32, 1/4, 5/16"
 lbs. .41 pkg. 1 Each \$6.78



351 93 Metric Hex L-wrench Set, 6 Pc. in Plastic Holder

Equipped with 1.5, 2.0, 2.5, 3.0, 4.0, 5.0mm
 lbs. .20 pkg. 1 Each \$4.98



351 94 Inch Hex L-wrench Set, 13 Pc. in Plastic Holder

Equipped with .050 - 3/8"
 lbs. .68 pkg. 1 Each \$11.48

Short Arm Hex L-keys Black Finish



• Ideal for use in clean rooms & other environments where non-oxidizing surfaces are specified or required.

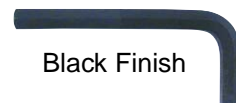

Black Finish

353 Metric L-wrench Hex Key, Short Arm, high alloy CVM steel, hardened, black finish. Precision machined, burr free chamfered ends.

| Item No. | Size | mm | Inch | mm | Inch | pkg. | Each |
|----------|------|------|------|-----|------|------|----------|
| 353 01 | 0.7 | 31.5 | 1.24 | - | - | 10 | \$.50 |
| 353 02 | 0.9 | 32 | 1.26 | - | - | 10 | \$.50 |
| 353 03 | 1.3 | 41 | 1.61 | 13 | .50 | 10 | \$.22 |
| 353 04 | 1.5 | 46 | 1.81 | 15 | .58 | 10 | \$.22 |
| 353 05 | 2.0 | 51 | 2.01 | 18 | .70 | 10 | \$.22 |
| 353 06 | 2.5 | 57 | 2.21 | 20 | .78 | 10 | \$.24 |
| 353 07 | 3.0 | 64 | 2.52 | 23 | .90 | 10 | \$.32 |
| 353 08 | 4.0 | 72 | 2.83 | 29 | 1.13 | 10 | \$.38 |
| 353 09 | 5.0 | 83 | 3.27 | 33 | 1.29 | 10 | \$.52 |
| 353 10 | 6.0 | 94 | 3.70 | 38 | 1.49 | 10 | \$.62 |
| 353 11 | 7.0 | 99 | 3.90 | 41 | 1.60 | 10 | \$.82 |
| 353 12 | 8.0 | 105 | 4.13 | 44 | 1.72 | 10 | \$ 1.10 |
| 353 13 | 9.0 | 112 | 4.41 | 47 | 1.84 | 10 | \$ 1.50 |
| 353 14 | 10.0 | 119 | 4.69 | 50 | 1.96 | 10 | \$ 1.78 |
| 353 16 | 11.0 | 126 | 4.96 | 53 | 2.07 | 10 | \$ 2.10 |
| 353 17 | 12.0 | 134 | 5.28 | 57 | 2.23 | 1 | \$ 3.40 |
| 353 18 | 14.0 | 151 | 5.94 | 70 | 2.74 | 1 | \$ 5.08 |
| 353 19 | 17.0 | 173 | 6.81 | 80 | 3.13 | 1 | \$ 7.38 |
| 353 20 | 19.0 | 195 | 7.68 | 89 | 3.49 | 1 | \$ 11.12 |
| 353 21 | 22.0 | 217 | 8.89 | 102 | 4.00 | 1 | \$ 27.52 |

353 Inch L-wrench Hex Key, Short Arm black finish

| Item No. | Size | mm | Inch | mm | Inch | pkg. | Each |
|----------|------|-----|------|----|------|------|----------|
| 353 30 | .050 | 41 | 1.61 | 10 | .39 | 10 | \$.26 |
| 353 31 | 1/16 | 47 | 1.85 | 16 | .63 | 10 | \$.26 |
| 353 32 | 5/64 | 51 | 2.01 | 16 | .63 | 10 | \$.30 |
| 353 33 | 3/32 | 55 | 2.17 | 19 | .75 | 10 | \$.34 |
| 353 34 | 7/64 | 58 | 2.28 | 19 | .75 | 10 | \$.34 |
| 353 35 | 1/8 | 61 | 2.40 | 21 | .83 | 10 | \$.42 |
| 353 36 | 9/64 | 65 | 2.56 | 23 | .91 | 10 | \$.42 |
| 353 37 | 5/32 | 72 | 2.83 | 25 | .99 | 10 | \$.46 |
| 353 38 | 3/16 | 76 | 2.99 | 26 | 1.0 | 10 | \$.58 |
| 353 39 | 7/32 | 84 | 3.31 | 29 | 1.2 | 10 | \$.74 |
| 353 40 | 1/4 | 94 | 3.70 | 31 | 1.2 | 10 | \$.78 |
| 353 41 | 5/16 | 106 | 4.17 | 36 | 1.4 | 10 | \$ 1.36 |
| 353 42 | 3/8 | 117 | 4.61 | 38 | 1.5 | 10 | \$ 2.16 |
| 353 43 | 1/2 | 143 | 5.63 | 44 | 1.7 | 1 | \$ 4.50 |
| 353 45 | 9/16 | 158 | 6.22 | 64 | 2.5 | 1 | \$ 4.98 |
| 353 46 | 5/8 | 176 | 6.93 | 71 | 2.8 | 1 | \$ 7.26 |
| 353 47 | 3/4 | 198 | 7.80 | 89 | 3.5 | 1 | \$ 11.80 |
| 353 48 | 1" | 220 | 8.66 | - | - | 1 | \$ 29.70 |



353 90 Metric Hex L-wrench Set, 9 Pc. in Plastic Holder

Equipped with 1.5, 2.0, 2.5, 3.0, 4.0, 5.0, 6.0, 8.0, 10.0mm
 lbs. .59 pkg. 1 Each \$8.98



353 91 Inch Hex L-wrench Set, 13 Pc. in Plastic Holder

Equipped with .050 - 3/8"
 lbs. .41 pkg. 1 Each \$10.98





Made in Germany



www.wihatools.com

Click on page number to view product

Wiha Maxiflex Hose System Index

| | Description | Page |
|---|---------------------------|------|
|  | Maxiflex Hose System 1/4" | 45 |
|  | Maxiflex Hose System 1/2" | 46 |

Wiha Hammers Index

| | Description | Page |
|--|-------------------|------|
|  | Dead Blow Hammers | 47 |
|  | Sledge Hammers | 47 |



Wiha Maxiflex Hose System



Flexible hose system for fluids & air

Resistant to chemicals and solvents, non-conductive

Will not alter under pressure or machine vibrations

NEW
from Wiha

A practical holder allows you to set the hose for many diverse applications in fixed constructions.

Available in 1/4" & 1/2" Diameters

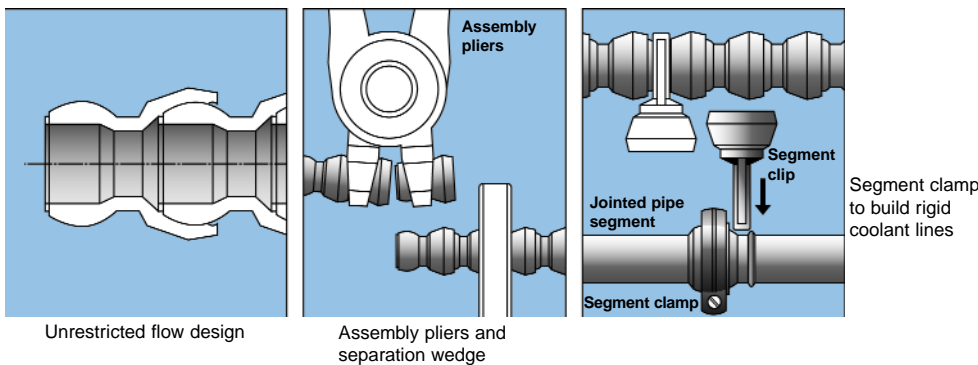

Product Features:

- Flexible hose system for cooling and cleaning in sawing, drilling, turning, milling, grinding and EDM applications 1/4" or 1/2"
- Dimensionally stable through tight fitting components. Will not alter under pressure or machine vibrations
- Resistant to chemicals and solvents, non-conductive
- Compatible with competitive systems
- Ideally suited for positioning and distributing fluids & air

Maxiflex is a universal articulated hose system with the greatest flexibility. The broad range of hose joints, nozzles, threaded connectors, Y-junctions and in line valves allow for a perfect solution to every cooling or cleaning problem. A high quality and indestructible plastic, extensive design knowledge and precise manufacturing of all components ensures that this flexible hose system functions for each individual application without deforming. Adapters enable the user to expand the maxiflex and incorporate other flexible hose systems.

Besides transporting and distributing cooling and cleaning agents the Maxiflex offers more possibilities: use in air vacuum or blowing systems as well as the distribution of various solvents. A practical holder allows you to set the hose for many diverse applications in fixed constructions.



Made in Germany

Toll Free: (800) 494-6104

Click image to view web page

Wiha Maxiflex Hose System 1/4"

344 90 Maxiflex Starter Kit
 2 Threaded Connectors R 1/4" & R 1/8"
 3 Cylindrical Nozzles 1/16", 1/8", 7/32"
 22 Segments - 11"

| Item No. | OAL | pkg. | Each |
|----------|-------------|------|--------|
| 344 90 | 320mm/12.6" | 1 | \$8.95 |



344 02 Segments
 1/4" - Pack with 22 segments 11"

| Item No. | OAL | pkg. | Each |
|----------|-------------|------|--------|
| 344 02 | 280mm/11.0" | 1 | \$4.84 |



344 04 1/16" Nozzle
 1/4" - Nozzle Ø 1.6mm - 1/16"

| Item No. | Dia. | pkg. | Each |
|----------|-------------|------|--------|
| 344 04 | 1.6mm/.620" | 1 | \$1.12 |



344 06 1/8" Nozzle
 1/4" - Nozzle Ø 3.2mm - 1/8"

| Item No. | Dia. | pkg. | Each |
|----------|-------------|------|--------|
| 344 06 | 3.2mm/.125" | 1 | \$1.12 |



344 08 7/32" Nozzle
 1/4" - Nozzle Ø 5.6mm - 7/32"

| Item No. | Dia. | pkg. | Each |
|----------|------------|------|--------|
| 344 08 | 5.6mm/.22" | 1 | \$1.12 |



344 10 Straight Flat Nozzle
 1/4" - Flat Nozzle 24mm wide

| Item No. | Width | pkg. | Each |
|----------|-----------|------|--------|
| 344 10 | 24mm/.94" | 1 | \$3.98 |



344 12 Straight Multi Hole Nozzle
 1/4" - Multi Hole Nozzle 24mm wide

| Item No. | Width | pkg. | Each |
|----------|-----------|------|--------|
| 344 12 | 24mm/.94" | 1 | \$3.98 |



344 14 1/16" Nozzle 90° Bend
 1/4" - Angular Nozzle Ø 1.6mm - 1/16"

| Item No. | Dia. | pkg. | Each |
|----------|-------------|------|--------|
| 344 14 | 1.6mm/.620" | 1 | \$1.40 |



344 16 1/8" Nozzle 90° Bend
 1/4" - Angular Nozzle Ø 3.2mm - 1/8"

| Item No. | Dia. | pkg. | Each |
|----------|-------------|------|--------|
| 344 16 | 3.2mm/.125" | 1 | \$1.40 |



344 18 7/32" Nozzle 90° Bend
 1/4" - Angular Nozzle Ø 5.6mm - 7/32"

| Item No. | Dia. | pkg. | Each |
|----------|------------|------|--------|
| 344 18 | 5.6mm/.22" | 1 | \$1.40 |



344 20 Multi Hole Spray Bar
 1/4" - Right Angle Multi Hole Nozzle

| Item No. | Width | pkg. | Each |
|----------|-----------|------|--------|
| 344 20 | 24mm/.94" | 1 | \$3.20 |

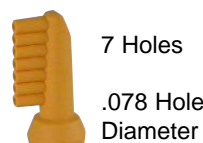

344 32 Adapter for LcLn - 1/4"

| Item No. | OAL | pkg. | Each |
|----------|-------|------|--------|
| 344 32 | 7x2mm | 1 | \$2.90 |



344 34 Male Double End Segment

| Item No. | Size | pkg. | Each |
|----------|------|------|--------|
| 344 34 | 1/4" | 1 | \$3.20 |



344 36 Female Double End Segment

| Item No. | Size | pkg. | Each |
|----------|------|------|--------|
| 344 36 | 1/4" | 1 | \$3.20 |



344 22 BSPT Threaded Connector R 1/8"

| Item No. | Size | pkg. | Each |
|----------|------|------|--------|
| 344 22 | 1/8" | 1 | \$1.12 |



344 24 BSPT Threaded Connector R 1/4"

| Item No. | Size | pkg. | Each |
|----------|------|------|--------|
| 344 24 | 1/4" | 1 | \$1.12 |



344 26 NPT Threaded Connector R 1/8"

| Item No. | Size | pkg. | Each |
|----------|------|------|--------|
| 344 26 | 1/8" | 1 | \$1.12 |



344 28 NPT Threaded Connector R 1/4"

| Item No. | Size | pkg. | Each |
|----------|------|------|--------|
| 344 28 | 1/4" | 1 | \$1.12 |



344 30 1/4" Y-Junction

| Item No. | Size | pkg. | Each |
|----------|------|------|--------|
| 344 30 | 1/4" | 1 | \$3.20 |



344 38 In Line Valve

| Item No. | Size | pkg. | Each |
|----------|------|------|--------|
| 344 38 | 1/4" | 1 | \$6.40 |



344 40 Segment Clip

| Item No. | Size | pkg. | Each |
|----------|------|------|--------|
| 344 40 | 1/4" | 1 | \$3.20 |



344 42 Separation Wedge

| Item No. | Size | pkg. | Each |
|----------|------|------|--------|
| 344 42 | 1/4" | 1 | \$3.98 |



344 44 Assembly Pliers

| Item No. | Size | pkg. | Each |
|----------|------|------|---------|
| 344 44 | 1/4" | 1 | \$14.98 |





Made in Germany

www.wihatools.com

Click image to view web page

Wiha Maxiflex Hose System 1/2"

340 90 Maxiflex Starter Kit
2 Threaded Connectors R 1/2" & 3/8" NPT
Straight, 90° Bend & Multi Hole Nozzles
12 Segments - 12.6"

| Item No. | OAL | pkg. | Each |
|----------|-------------|------|---------|
| 340 90 | 320mm/12.6" | 1 | \$13.98 |



340 00 Segments
1/2" - Pack with 12 segments 11"

| Item No. | OAL | pkg. | Each |
|----------|-----------|------|--------|
| 340 00 | 279mm/11" | 1 | \$5.28 |



340 46 1/2" Pipe Segment

| Item No. | OAL | pkg. | Each |
|----------|-------|------|--------|
| 340 46 | 4.25" | 1 | \$3.60 |



340 48 1/2" Segment Clamp
Including Screws

| Item No. | pkg. | Each |
|----------|------|--------|
| 340 48 | 1 | \$2.98 |



340 02 1/2" Straight Nozzle
1/2" - Nozzles Ø 10mm

| Item No. | Dia. | pkg. | Each |
|----------|------------|------|--------|
| 340 02 | 10mm/.393" | 1 | \$1.20 |



340 08 Straight Multi Hole Nozzle
1/2" - Multi Hole Nozzle 30mm wide

| Item No. | Width | pkg. | Each |
|----------|-----------|------|--------|
| 340 08 | 30mm/1.2" | 1 | \$5.40 |



340 04 Straight Flat Nozzle
1/2" - Flat Nozzle 30mm wide

| Item No. | Width | pkg. | Each |
|----------|-----------|------|--------|
| 340 04 | 30mm/1.2" | 1 | \$5.20 |



340 06 Straight Flat Nozzle
1/2" - Flat Nozzle 60mm wide

| Item No. | Width | pkg. | Each |
|----------|-----------|------|--------|
| 340 06 | 60mm/2.4" | 1 | \$5.60 |



340 12 Nozzle 90° Bend
1/2" - Angular Nozzle Ø 7mm

| Item No. | Dia. | pkg. | Each |
|----------|-----------|------|--------|
| 340 12 | 7mm/.275" | 1 | \$1.98 |



340 10 Nozzle 90° Bend
1/2" - Angular Nozzle Ø 10mm

| Item No. | Dia. | pkg. | Each |
|----------|------------|------|--------|
| 340 10 | 10mm/.393" | 1 | \$1.98 |



340 14 Multi Hole Angular Nozzle
1/2" - Right Angle Side Spray Nozzle

| Item No. | Width | pkg. | Each |
|----------|-----------|------|--------|
| 340 14 | 45mm/1.7" | 1 | \$3.98 |



340 28 Reducer Adapter 1/2" to 1/4"

| Item No. | Size | pkg. | Each |
|----------|------|------|--------|
| 340 28 | 1/2" | 1 | \$2.98 |



340 30 Adapter - 1/2" LcLn

| Item No. | Size | pkg. | Each |
|----------|------|------|--------|
| 340 30 | 1/2" | 1 | \$2.90 |



340 34 Female Double End Segment

| Item No. | Size | pkg. | Each |
|----------|------|------|--------|
| 340 34 | 1/2" | 1 | \$3.98 |



340 36 Male Double End Segment

| Item No. | Size | pkg. | Each |
|----------|------|------|--------|
| 340 36 | 1/2" | 1 | \$3.98 |



340 16 BSPT Threaded Connector R 3/8"

| Item No. | Size | pkg. | Each |
|----------|------|------|--------|
| 340 16 | 1/8" | 1 | \$1.20 |



340 18 BSPT Threaded Connector R 1/2"

| Item No. | Size | pkg. | Each |
|----------|------|------|--------|
| 340 18 | 1/4" | 1 | \$1.20 |



340 20 NPT Threaded Connector R 3/8"

| Item No. | Size | pkg. | Each |
|----------|------|------|--------|
| 340 20 | 1/8" | 1 | \$1.20 |



340 22 NPT Threaded Connector R 1/2"

| Item No. | Size | pkg. | Each |
|----------|------|------|--------|
| 340 22 | 1/4" | 1 | \$1.20 |



340 24 Y-Junction

| Item No. | Size | pkg. | Each |
|----------|------|------|--------|
| 340 24 | 1/2" | 1 | \$4.40 |



340 26 Y Reducer Junction 1/2"-1/4"

| Item No. | Size | pkg. | Each |
|----------|------|------|--------|
| 340 26 | 1/2" | 1 | \$4.40 |



340 38 In Line Valve

| Item No. | Size | pkg. | Each |
|----------|------|------|--------|
| 340 38 | 1/2" | 1 | \$9.20 |



340 40 Segment Clip

| Item No. | Size | pkg. | Each |
|----------|------|------|--------|
| 340 40 | 1/2" | 1 | \$3.98 |



340 42 Separation Wedge

| Item No. | Size | pkg. | Each |
|----------|------|------|--------|
| 340 42 | 1/2" | 1 | \$5.98 |



340 44 Assembly Pliers

| Item No. | Size | pkg. | Each |
|----------|------|------|---------|
| 340 44 | 1/2" | 1 | \$14.98 |





Made in Germany

Toll Free: (800) 494-6104

Click image to view web page

Dead Blow and Sledge Hammers



802 Dead Blow, Medium Hard Face Hammer, Recoilless, Polyurethane, Steel Tube Shaft. "GS" Sign, Cushion Grip.

- Preserves sensitive surfaces and edges.
- Increases striking power.
- Avoids hand fatigue.

Application:

- Machine tools and gear box construction.
- Sheet metal shops and repair shops.

Faces polyurethane, shatterproof, wear resistant, extremely durable.

Faces replaceable. Tubular handle, lacquered in blue, cushion grip.

| Item No. | mm | Inch | mm | Inch | mm | Inch | oz. | pkg. | Each |
|----------|----|------|-----|------|-----|------|-----|------|---------|
| 802 25 | 25 | 1.0 | 106 | 4.2 | 288 | 11.3 | 18 | 1 | \$25.98 |
| 802 30 | 30 | 1.2 | 115 | 4.5 | 290 | 11.4 | 19 | 1 | \$25.98 |
| 802 35 | 35 | 1.4 | 118 | 4.6 | 300 | 11.8 | 22 | 1 | \$26.98 |
| 802 40 | 40 | 1.6 | 125 | 4.9 | 305 | 12.0 | 26 | 1 | \$30.98 |
| 802 45 | 45 | 1.8 | 130 | 5.1 | 310 | 12.2 | 30 | 1 | \$34.98 |
| 802 50 | 50 | 2.0 | 130 | 5.1 | 365 | 14.4 | 40 | 1 | \$38.98 |
| 802 60 | 60 | 2.3 | 156 | 6.1 | 375 | 14.7 | 72 | 1 | \$52.98 |
| 802 70 | 70 | 2.8 | 161 | 6.3 | 385 | 15.1 | 97 | 1 | \$63.98 |



802 Replacement Hammer Faces - Medium hard.

| Item No. | mm | Inch | lbs. | pkg. | Each |
|----------|----|------|------|------|---------|
| 802 00 | 25 | 1.0 | .04 | 1 | \$3.90 |
| 802 02 | 30 | 1.2 | .04 | 1 | \$4.00 |
| 802 04 | 35 | 1.4 | .05 | 1 | \$4.70 |
| 802 06 | 40 | 1.6 | .08 | 1 | \$5.30 |
| 802 08 | 45 | 1.8 | .12 | 1 | \$6.30 |
| 802 10 | 50 | 2.0 | .16 | 1 | \$7.20 |
| 802 13 | 60 | 2.3 | .29 | 1 | \$10.10 |
| 802 16 | 70 | 2.8 | .39 | 1 | \$11.10 |



802 90 3 Piece Dead Blow Hammer Set - Medium hard.

| Item No. | mm | Inch | lbs. |
|----------|--------|------|---------|
| 802 90 | 802 30 | 30 | 6.35 |
| | 802 40 | 40 | Each |
| | 802 50 | 50 | \$95.00 |



800 Dead Blow, Medium Hard Face, Recoilless, Polyurethane Face, Hickory Handle. Application:

- Tools, engineering gear box construction.
- Sheet metal and repair shops, heavy industry.

Steel head for incredible strength. Faces polyurethane, shatterproof, wear resistant, extremely durable. Faces replaceable. Hickory handle.

| Item No. | mm | Inch | mm | Inch | mm | Inch | oz. | pkg. | Each |
|----------|----|------|-----|------|-----|------|------|------|---------|
| 800 25 | 25 | 1.0 | 106 | 4.2 | 320 | 12.5 | 18.3 | 1 | \$22.98 |
| 800 30 | 30 | 1.2 | 113 | 4.4 | 350 | 13.7 | 20.9 | 1 | \$22.98 |
| 800 35 | 35 | 1.4 | 115 | 4.5 | 355 | 13.9 | 24.9 | 1 | \$23.98 |
| 800 40 | 40 | 1.6 | 123 | 4.8 | 375 | 14.7 | 29.9 | 1 | \$27.98 |
| 800 45 | 45 | 1.8 | 130 | 5.1 | 380 | 14.9 | 37.3 | 1 | \$31.98 |
| 800 50 | 50 | 2.0 | 134 | 5.3 | 385 | 15.1 | 49.4 | 1 | \$35.98 |
| 800 60 | 60 | 2.3 | 158 | 6.2 | 420 | 16.5 | 72.0 | 1 | \$49.98 |
| 800 70 | 70 | 2.8 | 158 | 6.2 | 430 | 16.9 | 97.0 | 1 | \$60.98 |



802 Replacement Hammer Faces - Medium hard.

| Item No. | mm | Inch | lbs. | pkg. | Each |
|----------|----|------|------|------|---------|
| 802 00 | 25 | 1.0 | .04 | 1 | \$3.90 |
| 802 02 | 30 | 1.2 | .04 | 1 | \$4.00 |
| 802 04 | 35 | 1.4 | .05 | 1 | \$4.70 |
| 802 06 | 40 | 1.6 | .08 | 1 | \$5.30 |
| 802 08 | 45 | 1.8 | .12 | 1 | \$6.30 |
| 802 10 | 50 | 2.0 | .16 | 1 | \$7.20 |
| 802 13 | 60 | 2.3 | .29 | 1 | \$10.10 |
| 802 16 | 70 | 2.8 | .39 | 1 | \$11.10 |



802 Dead Blow Sledge, Medium Hard Face, Recoilless, Polyurethane Face, Hickory Handle. Application:

- Tools, engineering gear box construction.
- Sheet metal and repair shops, heavy industry.

Faces polyurethane, shatterproof, wear resistant, extremely durable.

Faces replaceable. Hickory handle.

| Item No. | mm | Inch | mm | Inch | mm | Inch | lbs. | pkg. | Each |
|----------|-----|------|-----|------|------|------|------|------|----------|
| 802 80 | 80 | 3.1 | 205 | 8.0 | 882 | 34.6 | 10.0 | 1 | \$149.98 |
| 802 99 | 100 | 3.9 | 210 | 8.2 | 1002 | 39.3 | 15.1 | 1 | \$221.98 |

802 Replacement Hammer Tips - Medium hard.

| Item No. | mm | Inch | lbs. | pkg. | Each |
|----------|-----|------|------|------|---------|
| 802 19 | 80 | 3.1 | .06 | 1 | \$12.98 |
| 802 22 | 100 | 3.9 | .10 | 1 | \$18.98 |





Made in Germany

Toll Free: (800) 494-6104

Click image to view web page

Wiha SoftFinish® Handle - Ergonomic Cushion Grip

Wiha SoftFinish® Handle: Featuring advanced technology dual material molding. A remarkable improvement in handle design, comfort and performance. The SoftFinish® ergonomic shape allows maximum torque and user comfort.

Wiha exclusive "SoftFinish® Zone" features solid molded core with soft outer cushion grip. Requires less force, yet achieves 40% more torque than conventional handles.

Wiha tips are precision machined to exact tolerances for a perfect fit every time.

All blades are made of Wiha's exclusive formula chrome-vanadium-molybdenum tool steel, super hardened plated for unmatched durability.

Handle is molded directly onto the blade for a permanent bond. Large optimized handle diameter allows higher torque with less user hand fatigue.

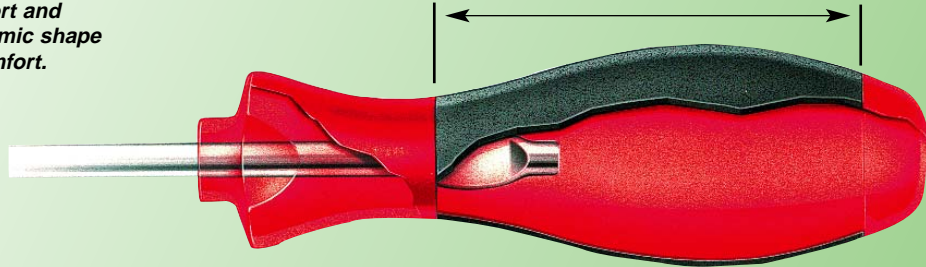

341 Nut Driver, With Wiha-SoftFinish® Handle. Inch sizes. Blade CVM steel, hardened. Deep drawn 1" socket. Solid shafts. Wiha-SoftFinish® handle, multi-component, cushion grips.

| Item | | | | | | | | |
|--------|-------|------|-----|-----|------|------|------|--------|
| No. | Inch | Inch | mm | mm | Inch | lbs. | pkg. | Each |
| 341 34 | 9/64 | 5.0 | 125 | 231 | 9.1 | .18 | 10 | \$5.90 |
| 341 35 | 5/32 | 5.0 | 125 | 238 | 9.4 | .24 | 10 | \$5.90 |
| 341 36 | 3/16 | 5.0 | 125 | 238 | 9.4 | .25 | 10 | \$5.90 |
| 341 37 | 7/32 | 5.0 | 125 | 238 | 9.4 | .26 | 10 | \$5.90 |
| 341 38 | 1/4 | 5.0 | 125 | 246 | 9.7 | .38 | 10 | \$5.90 |
| 341 39 | 5/16 | 5.0 | 125 | 246 | 9.7 | .40 | 10 | \$5.90 |
| 341 40 | 11/32 | 5.0 | 125 | 246 | 9.7 | .40 | 10 | \$6.00 |
| 341 41 | 3/8 | 5.0 | 125 | 246 | 9.7 | .40 | 10 | \$6.10 |
| 341 42 | 7/16 | 5.0 | 125 | 246 | 9.7 | .40 | 10 | \$7.00 |
| 341 43 | 1/2 | 5.0 | 125 | 246 | 9.7 | .40 | 10 | \$7.50 |
| 341 44 | 9/16 | 5.0 | 125 | 246 | 9.7 | .40 | 10 | \$8.90 |
| 341 45 | 5/8 | 5.0 | 125 | 246 | 9.7 | .40 | 10 | \$9.90 |



341 93 Set 7 Pcs. Nut Driver Inch Sizes

Blade chrome-vanadium-molybdenum steel, hardened. Deep drawn 1" socket. Wiha-SoftFinish® handle, multi-component.

| Item | | | | | | | |
|--------|--------|-------|------|--------|------|-----|---------|
| No. | Inch | mm | Inch | mm | lbs. | | |
| 341 93 | 341 36 | 3/16 | 125 | 341 41 | 3/8 | 125 | 1.89 |
| | 341 38 | 1/4 | 125 | 341 42 | 7/16 | 125 | |
| | 341 39 | 5/16 | 125 | 341 43 | 1/2 | 125 | Each |
| | 341 40 | 11/32 | 125 | | | | \$43.80 |



341 Nut Driver, With Wiha-SoftFinish® Handle
Blade CVM steel, hardened. Deep drawn 1" socket. Solid shafts. Wiha-SoftFinish® handle, multi-component, cushion grips.

| Item | | | | | | | | |
|--------|------|-----|------|-----|------|------|------|--------|
| No. | mm | mm | Inch | mm | Inch | lbs. | pkg. | Each |
| 341 20 | 5.0 | 125 | 5.0 | 215 | 8.5 | .14 | 10 | \$5.90 |
| 341 21 | 5.5 | 125 | 5.0 | 215 | 8.5 | .14 | 10 | \$5.90 |
| 341 22 | 6.0 | 125 | 5.0 | 215 | 8.5 | .15 | 10 | \$5.90 |
| 341 23 | 7.0 | 125 | 5.0 | 238 | 9.4 | .25 | 10 | \$5.90 |
| 341 24 | 8.0 | 125 | 5.0 | 238 | 9.4 | .25 | 10 | \$5.90 |
| 341 25 | 9.0 | 125 | 5.0 | 238 | 9.4 | .26 | 10 | \$6.00 |
| 341 26 | 10.0 | 125 | 5.0 | 238 | 9.4 | .27 | 10 | \$6.10 |
| 341 27 | 11.0 | 125 | 5.0 | 247 | 9.7 | .37 | 10 | \$7.00 |
| 341 28 | 12.0 | 125 | 5.0 | 247 | 9.7 | .40 | 10 | \$7.30 |
| 341 29 | 13.0 | 125 | 5.0 | 247 | 9.7 | .40 | 10 | \$7.50 |
| 341 30 | 14.0 | 125 | 5.0 | 247 | 9.7 | .40 | 10 | \$8.90 |
| 341 31 | 15.0 | 125 | 5.0 | 247 | 9.7 | .40 | 10 | \$9.50 |



341 94 Set 7 Pcs. Nut Driver Metric Sizes

| Item | | | | | | | |
|--------|--------|-----|-----|--------|------|-----|---------|
| No. | mm | mm | mm | mm | lbs. | | |
| 341 94 | 341 20 | 5.0 | 125 | 341 24 | 8.0 | 125 | 1.89 |
| | 341 21 | 5.5 | 125 | 341 26 | 10.0 | 125 | |
| | 341 22 | 6.0 | 125 | 341 29 | 13.0 | 125 | Each |
| | 341 23 | 7.0 | 125 | | | | \$42.80 |



Made in Germany

www.wihatools.com

Click image to view web page

Wiha SoftFinish® Heavy Duty Nut Drivers



347 Nut Driver With Hex Bolster & Wiha-SoftFinish® Handle

Blade CVM steel, hardened. Deep drawn 1" socket. Hex bolster for additional torque, Solid shafts. Wiha-SoftFinish® cushion grip handle.

| Item No. | mm | mm | mm | mm | Inch | lbs. | pkg. | Each |
|----------|------|-----|------|-----|------|------|------|---------|
| 347 12 | 7.0 | 125 | 10.0 | 238 | 9.4 | .25 | 10 | \$8.90 |
| 347 15 | 8.0 | 125 | 10.0 | 238 | 9.4 | .25 | 10 | \$9.40 |
| 347 18 | 9.0 | 125 | 10.0 | 238 | 9.4 | .26 | 10 | \$10.20 |
| 347 21 | 10.0 | 125 | 10.0 | 238 | 9.4 | .27 | 10 | \$10.60 |
| 347 24 | 11.0 | 125 | 13.0 | 247 | 9.7 | .37 | 10 | \$12.00 |
| 347 27 | 12.0 | 125 | 13.0 | 247 | 9.7 | .40 | 10 | \$13.00 |
| 347 30 | 13.0 | 125 | 13.0 | 247 | 9.7 | .40 | 10 | \$13.50 |
| 347 33 | 14.0 | 125 | 13.0 | 247 | 9.7 | .40 | 10 | \$17.70 |



347 Nut Driver, With Wiha-SoftFinish® Handle. Inch sizes.

| Item No. | Inch | Inch | mm | Inch | mm | Inch | lbs. | pkg. | Each |
|----------|------|------|-----|------|-----|------|------|------|---------|
| 347 53 | 3/16 | 5.0 | 125 | 5/16 | 231 | 9.1 | .18 | 10 | \$7.90 |
| 347 59 | 1/4 | 5.0 | 125 | 3/8 | 238 | 9.4 | .24 | 10 | \$7.90 |
| 347 65 | 5/16 | 5.0 | 125 | 3/8 | 238 | 9.4 | .25 | 10 | \$9.70 |
| 347 71 | 3/8 | 5.0 | 125 | 3/8 | 238 | 9.4 | .26 | 10 | \$10.80 |
| 347 74 | 7/16 | 5.0 | 125 | 1/2 | 246 | 9.7 | .38 | 10 | \$12.70 |
| 347 77 | 1/2 | 5.0 | 125 | 1/2 | 246 | 9.7 | .40 | 10 | \$13.80 |

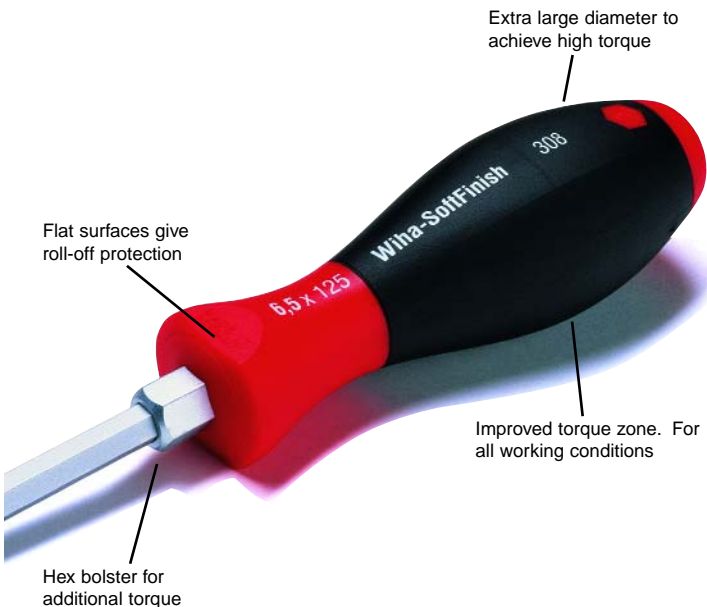

347 91 Set 5 Pcs. Nut Driver Metric Sizes

Blade chrome-vanadium-molybdenum steel, hardened.

Deep drawn 1" socket. Hex bolster for additional torque.

Wiha-SoftFinish® handle, multi-component, cushion grips.

| Item No. | mm | mm | mm | mm | lbs. |
|----------|---------|-----|-----|-------------|---------|
| 347 91 | *341 20 | 5.0 | 125 | 347 21 10.0 | 1.42 |
| | *341 22 | 6.0 | 125 | 347 24 11.0 | Each |
| | 347 15 | 8.0 | 125 | | \$47.50 |

*Standard blade - no hex bolster.



347 92 Set 6 Pcs. Nut Driver Inch Sizes

| Item No. | Inch | Inch | Inch | Inch | lbs. |
|----------|--------|------|------|-------------|---------|
| 347 92 | 347 53 | 3/16 | 5.0 | 347 71 3/8 | 1.94 |
| | 347 59 | 1/4 | 5.0 | 347 74 7/16 | Each |
| | 347 65 | 5/16 | 5.0 | 347 77 1/2 | \$62.80 |



Made in Germany

Toll Free: (800) 494-6104

Click image to view web page

Wiha SoftFinish® Nut Drivers - Hollow Shaft



343 Hollow Shaft Nut Driver-Wiha-SoftFinish® Handle. Inch sizes.

| Item No. | ⌀ Inch | — Inch | — mm | — mm | — Inch | — lbs. | — pkg. | Each |
|----------|--------|--------|------|------|--------|--------|--------|--------|
| 343 36 | 3/16 | 3.0 | 70 | 175 | 7.0 | .18 | 10 | \$5.98 |
| 343 38 | 1/4 | 3.0 | 70 | 175 | 7.0 | .24 | 10 | \$5.98 |
| 343 39 | 5/16 | 3.0 | 70 | 182 | 7.0 | .25 | 10 | \$6.98 |
| 343 40 | 11/32 | 3.0 | 70 | 182 | 7.5 | .25 | 10 | \$6.98 |
| 343 41 | 3/8 | 3.0 | 70 | 182 | 7.5 | .26 | 10 | \$6.98 |
| 343 42 | 7/16 | 3.0 | 70 | 187 | 7.6 | .38 | 10 | \$7.98 |
| 343 43 | 1/2 | 3.0 | 70 | 187 | 7.6 | .40 | 10 | \$8.98 |

343 90 Set 7 Pcs. Hollow Shaft Nut Driver Inch Sizes

| Item No. | ⌀ Inch | — Inch | ⌀ Inch | — Inch | — lbs. | | |
|----------|--------|--------|--------|--------|--------|-----|---------|
| 343 90 | 343 36 | 3/16 | 5.0 | 343 41 | 3/8 | 5.0 | 1.55 |
| | 343 38 | 1/4 | 5.0 | 343 42 | 7/16 | 5.0 | |
| | 343 39 | 5/16 | 5.0 | 343 43 | 1/2 | 5.0 | Each |
| | 343 40 | 11/32 | 5.0 | | | | \$49.78 |



343 Hollow Shaft Nut Driver With Wiha-SoftFinish® Handle

| Item No. | ⌀ mm | — mm | — mm | — Inch | — lbs. | — pkg. | Each |
|----------|------|------|------|--------|--------|--------|--------|
| 343 02 | 5.0 | 70 | 175 | 8.5 | .14 | 10 | \$5.98 |
| 343 04 | 5.5 | 70 | 175 | 8.5 | .14 | 10 | \$5.98 |
| 343 06 | 6.0 | 70 | 175 | 8.5 | .15 | 10 | \$5.98 |
| 343 08 | 7.0 | 70 | 182 | 9.4 | .25 | 10 | \$6.98 |
| 343 10 | 8.0 | 70 | 182 | 9.4 | .25 | 10 | \$6.98 |
| 343 12 | 10.0 | 70 | 187 | 9.4 | .27 | 10 | \$7.98 |
| 343 14 | 13.0 | 70 | 187 | 9.7 | .40 | 10 | \$8.98 |

343 91 Set 7 Pcs. Hollow Shaft Nut Driver Metric Sizes

| Item No. | ⌀ mm | — mm | ⌀ mm | — mm | — lbs. | | |
|----------|--------|------|------|--------|--------|-----|---------|
| 343 91 | 343 02 | 5.0 | 125 | 343 10 | 8.0 | 125 | 1.41 |
| | 343 04 | 5.5 | 125 | 343 12 | 10.0 | 125 | |
| | 343 06 | 6.0 | 125 | 343 14 | 13.0 | 125 | Each |
| | 343 08 | 8.0 | 125 | | | | \$48.78 |





Made in Germany

www.wihatools.com

Click image to view web page

Wiha T-Handle Nut Drivers



336 Nut Driver, With Wiha T-handle Blade CVM steel, hardened, nickel-plated. Wiha T-handle high quality plastic, impact resistant. Deep drawn 1" socket, solid shaft.

| Item No. | mm | mm | mm | lbs. | pkg. | Each |
|----------|------|-----|-----|------|------|---------|
| 336 03 | 6.0 | 125 | 100 | .16 | 10 | \$6.70 |
| 336 06 | 8.0 | 125 | 100 | .18 | 10 | \$6.70 |
| 336 07 | 8.0 | 200 | 100 | .22 | 10 | \$13.40 |
| 336 09 | 9.0 | 125 | 100 | .23 | 10 | \$6.80 |
| 336 12 | 10.0 | 125 | 100 | .24 | 10 | \$7.10 |
| 336 20 | 12.0 | 125 | 100 | .26 | 10 | \$7.20 |
| 336 22 | 13.0 | 125 | 100 | .27 | 10 | \$7.20 |



336 Nut Driver, With Wiha T-handle Blade CVM steel, hardened, nickel-plated. Wiha T-handle high quality plastic, impact resistant. Deep drawn 1" socket, solid shaft.

| Item No. | Inch | Inch | Inch | lbs. | pkg. | Each |
|----------|------|------|------|------|------|--------|
| 336 53 | 3/16 | 6.0 | 4.0 | .16 | 10 | \$5.90 |
| 336 59 | 1/4 | 6.0 | 4.0 | .18 | 10 | \$6.50 |
| 336 65 | 5/16 | 6.0 | 4.0 | .19 | 10 | \$6.50 |
| 336 71 | 3/8 | 6.0 | 4.0 | .20 | 10 | \$6.80 |
| 336 74 | 7/16 | 6.0 | 4.0 | .26 | 10 | \$7.10 |
| 336 77 | 1/2 | 6.0 | 4.0 | .30 | 10 | \$7.10 |



339 Square Drive Socket Adapters, With Wiha-T-handle. Blade CVM steel, hardened, chrome-plated, ball retainer. Wiha-T-handle high quality plastic, impact resistant.

| Item No. | Size | mm | Inch | mm | Inch | lbs. | Each |
|----------|------|-----|------|-----|------|------|---------|
| 339 00 | 1/4 | 150 | 6.0 | 80 | 3.0 | .23 | \$7.90 |
| 339 20 | 3/8 | 150 | 6.0 | 100 | 4.0 | .23 | \$13.80 |
| 339 50 | 1/2 | 150 | 6.0 | 100 | 4.0 | .53 | \$18.90 |



336 90 Set 6 Pc. Nut Driver T-handle Inch Sizes

Blade CVM steel, hardened, nickel-plated. Wiha-T-handle high quality plastic, impact resistant. Deep drawn 1" socket, solid shaft.

| Item No. | Inch | Inch | Inch | Inch | lbs. |
|----------|--------|------|------|--------|-----------------|
| 336 90 | 336 53 | 3/16 | 6.0 | 336 71 | 3/8 6.0 1.58 |
| | 336 59 | 1/4 | 6.0 | 336 74 | 7/16 6.0 Each |
| | 336 65 | 5/16 | 6.0 | 336 77 | 1/2 6.0 \$39.48 |



336 91 Set 5 Pc. Nut Driver T-handle Metric Sizes

Blade CVM steel, hardened, nickel-plated. Wiha-T-handle high quality plastic, impact resistant. Deep drawn 1" socket, solid shaft.

| Item No. | mm | mm | mm | mm | lbs. |
|----------|--------|-----|-----|--------|---------------|
| 336 91 | 336 03 | 6.0 | 125 | 336 12 | 10.0 125 1.57 |
| | 336 06 | 8.0 | 125 | 336 22 | 13.0 125 Each |
| | 336 09 | 9.0 | 125 | | \$34.28 |



388 00 Bit Holder With Wiha T-handle

Magnetic, holds bit and screw. Retainer out of stainless steel. Hex shaft chrome-vanadium-molybdenum steel, nickel-plated. Wiha-T-handle high quality plastic, impact resistant.

| Item No. | Size | mm | Inch | mm | Inch | lbs. | pkg. | Each |
|----------|------|-----|------|----|------|------|------|--------|
| 388 00 | 1/4 | 150 | 6.0 | 80 | 3.0 | .18 | 1 | \$7.98 |



Made in Germany

Toll Free: (800) 494-6104

Click image to view web page

Insulated Nut Drivers - SoftFinish® Handle



322 Nut Driver, With Wiha-SoftFinish® Handle Insulation According to ASTM F-1505-01, New VDE Specification 0682/part 201 and IEC 900, Δ up to 1000 Volt. "GS" Sign. Individually Tested. Blade CVM steel, hardened. Insulation molded directly onto blade. Deep drawn 1" socket. Wiha-SoftFinish® handle, multi-component. Inch sizes

| Item | | | | | | | | | | |
|--------|------|------|-----|------|------|------|---------|--|--|--|
| No. | Inch | Inch | mm | Inch | lbs. | pkg. | Each | | | |
| 322 43 | 3/32 | 5.0 | 236 | 8.5 | .14 | 10 | \$6.80 | | | |
| 322 46 | 7/64 | 5.0 | 236 | 8.5 | .14 | 10 | \$6.80 | | | |
| 322 49 | 1/8 | 5.0 | 236 | 8.5 | .14 | 10 | \$6.80 | | | |
| 322 52 | 9/64 | 5.0 | 236 | 8.5 | .15 | 10 | \$7.70 | | | |
| 322 55 | 5/32 | 5.0 | 236 | 8.5 | .15 | 10 | \$7.70 | | | |
| 322 58 | 3/16 | 5.0 | 236 | 8.5 | .15 | 10 | \$7.90 | | | |
| 322 61 | 7/32 | 5.0 | 236 | 8.5 | .16 | 10 | \$7.90 | | | |
| 322 64 | 1/4 | 5.0 | 243 | 8.5 | .24 | 10 | \$7.90 | | | |
| 322 67 | 5/16 | 5.0 | 243 | 8.9 | .25 | 10 | \$9.50 | | | |
| 322 70 | 3/8 | 5.0 | 243 | 9.3 | .26 | 10 | \$10.70 | | | |
| 322 73 | 7/16 | 5.0 | 243 | 9.3 | .36 | 10 | \$11.60 | | | |
| 322 76 | 1/2 | 5.0 | 243 | 9.3 | .39 | 10 | \$12.20 | | | |
| 322 78 | 9/16 | 5.0 | 243 | 9.3 | .39 | 10 | \$12.40 | | | |
| 322 80 | 5/8 | 5.0 | 243 | 9.5 | .41 | 10 | \$13.70 | | | |



322 Nut Driver, With Wiha-SoftFinish® Handle Insulation According to ASTM F-1505-01, New VDE Specification 0682/part 201 and IEC 900, Δ up to 1000 Volt. "GS" Sign. Individually Tested. Blade CVM steel, hardened. Insulation molded directly onto blade. Deep drawn 1" socket. Wiha-SoftFinish® handle, multi-component. Metric Sizes

| Item | | | | | | | | | | |
|--------|------|-----|-----|------|------|------|---------|--|--|--|
| No. | mm | mm | mm | Inch | lbs. | pkg. | Each | | | |
| 322 06 | 4.0 | 125 | 236 | 9.3 | .15 | 10 | \$7.70 | | | |
| 322 09 | 5.0 | 125 | 236 | 9.3 | .16 | 10 | \$7.90 | | | |
| 322 12 | 5.5 | 125 | 236 | 9.3 | .16 | 10 | \$7.90 | | | |
| 322 15 | 6.0 | 125 | 236 | 9.3 | .16 | 10 | \$7.90 | | | |
| 322 18 | 7.0 | 125 | 243 | 9.3 | .25 | 10 | \$8.90 | | | |
| 322 21 | 8.0 | 125 | 243 | 9.6 | .25 | 10 | \$9.50 | | | |
| 322 24 | 9.0 | 125 | 243 | 9.6 | .25 | 10 | \$10.70 | | | |
| 322 27 | 10.0 | 125 | 243 | 9.6 | .27 | 10 | \$11.30 | | | |
| 322 30 | 11.0 | 125 | 243 | 9.6 | .37 | 10 | \$11.60 | | | |
| 322 33 | 12.0 | 125 | 243 | 9.6 | .38 | 10 | \$11.90 | | | |
| 322 36 | 13.0 | 125 | 243 | 9.6 | .39 | 10 | \$12.20 | | | |



322 92 Set 5 Pcs. Nut Driver Inch Sizes

| Item | | | | | | | | | | |
|--------|--------|------|------|--------|------|------|---------|------|------|------|
| No. | Inch | Inch | Inch | Inch | lbs. | Inch | Inch | Inch | Inch | lbs. |
| 322 92 | 322 61 | 7/32 | 5.0 | 322 70 | 3/8 | 5.0 | 1.52 | | | |
| | 322 64 | 1/4 | 5.0 | 322 76 | 1/2 | 5.0 | Each | | | |
| | 322 67 | 5/16 | 5.0 | | | | \$48.96 | | | |



322 94 Set 7 Pcs. Nut Driver Inch Sizes

| Item | | | | | | | | | | |
|--------|--------|------|------|--------|------|------|---------|------|------|------|
| No. | Inch | Inch | Inch | Inch | lbs. | Inch | Inch | Inch | Inch | lbs. |
| 322 94 | 322 58 | 3/16 | 5.0 | 322 70 | 3/8 | 5.0 | 2.24 | | | |
| | 322 61 | 7/32 | 5.0 | 322 73 | 7/16 | 5.0 | | | | |
| | 322 64 | 1/4 | 5.0 | 322 76 | 1/2 | 5.0 | Each | | | |
| | 322 67 | 5/16 | 5.0 | | | | \$69.98 | | | |



322 91 Set 5 Pcs. Nut Driver Metric Sizes

| Item | | | | | | | | | | |
|--------|--------|-----|-----|--------|------|-----|---------|----|----|------|
| No. | mm | mm | mm | mm | lbs. | mm | mm | mm | mm | lbs. |
| 322 91 | 322 15 | 6.0 | 125 | 322 24 | 9.0 | 125 | 1.36 | | | |
| | 322 18 | 7.0 | 125 | 322 27 | 10.0 | 125 | Each | | | |
| | 322 21 | 8.0 | 125 | | | | \$48.76 | | | |



322 93 Set 7 Pcs. Nut Driver Metric Sizes

| Item | | | | | | | | | | |
|--------|--------|-----|-----|--------|------|-----|---------|----|----|------|
| No. | mm | mm | mm | mm | lbs. | mm | mm | mm | mm | lbs. |
| 322 93 | 322 09 | 5.0 | 125 | 322 21 | 8.0 | 125 | 2.05 | | | |
| | 322 12 | 5.5 | 125 | 322 27 | 10.0 | 125 | | | | |
| | 322 15 | 6.0 | 125 | 322 36 | 13.0 | 125 | Each | | | |
| | 322 18 | 7.0 | 125 | | | | \$66.98 | | | |



Wiha Open End Wrenches

NEW
from Wiha

Made from 31CRV3 High Performance Tool Steel

Meets DIN 3110 / ISO10102 Specifications

Precision formed for an exact fit

Satin Chromed Sure Grip Body

The wrench specified by BMW, Mercedes & Rolls Royce

Polished heads

- Open End Inch/Metric
- SoftGrip Wrenches
- Combination Inch/Metric
- Box Wrenches Inch/Metric

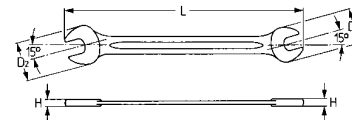
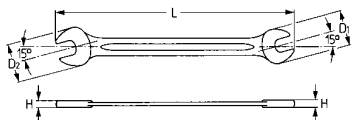

350 Open End Wrenches Metric DIN 3110 / ISO 10102

Made from 31CRV3 high performance tool steel. Satin chromed sure grip body. Polished Head. Precision formed for exact fit.

| Item No. | mm | mm | OAL mm | OAL Inch | H mm | D ¹ mm | D ² mm | lbs. | pkg. | Each |
|----------|-------------|-----|--------|----------|------|-------------------|-------------------|------|---------|------|
| 35001 | 4.0 x 5.0 | 103 | 4.0 | 3.3 | 11.6 | 13.7 | .02 | 10 | \$6.98 | |
| 35002 | 5.0 x 5.5 | 104 | 4.1 | 3.3 | 13.7 | 14.7 | .02 | 10 | \$6.98 | |
| 35003 | 5.5 x 7.0 | 122 | 4.8 | 3.6 | 15.7 | 17.7 | .04 | 10 | \$6.98 | |
| 35004 | 6.0 x 7.0 | 122 | 4.8 | 3.6 | 15.7 | 17.7 | .04 | 10 | \$6.98 | |
| 35005 | 7.0 x 8.0 | 130 | 5.1 | 3.9 | 17.7 | 20.8 | .06 | 10 | \$6.98 | |
| 35006 | 8.0 x 9.0 | 140 | 5.5 | 3.9 | 20.8 | 22.9 | .07 | 10 | \$6.98 | |
| 35007 | 8.0 x 10.0 | 140 | 5.5 | 3.9 | 20.8 | 22.9 | .07 | 10 | \$6.98 | |
| 35008 | 10.0 x 11.0 | 156 | 6.1 | 4.8 | 23.9 | 26.9 | .12 | 10 | \$6.98 | |
| 35009 | 10.0 x 13.0 | 172 | 6.7 | 5.3 | 24.0 | 30.0 | .15 | 10 | \$7.98 | |
| 35010 | 12.0 x 13.0 | 172 | 6.7 | 5.3 | 28.0 | 31.0 | .13 | 10 | \$7.98 | |
| 35011 | 12.0 x 14.0 | 172 | 6.7 | 5.3 | 28.0 | 31.0 | .13 | 10 | \$7.98 | |
| 35012 | 13.0 x 14.0 | 190 | 7.5 | 5.7 | 32.5 | 34.9 | .20 | 10 | \$7.98 | |
| 35013 | 14.0 x 15.0 | 190 | 7.5 | 5.7 | 32.5 | 34.9 | .20 | 10 | \$8.98 | |
| 35014 | 16.0 x 17.0 | 204 | 8.0 | 5.9 | 36.1 | 39.2 | .23 | 10 | \$9.98 | |
| 35015 | 16.0 x 18.0 | 204 | 8.0 | 5.9 | 36.1 | 39.2 | .23 | 10 | \$10.98 | |
| 35016 | 18.0 x 19.0 | 223 | 8.7 | 6.5 | 40.2 | 42.3 | .33 | 5 | \$10.98 | |
| 35017 | 19.0 x 22.0 | 236 | 9.3 | 6.8 | 44.9 | 48.4 | .42 | 5 | \$11.98 | |
| 35018 | 20.0 x 22.0 | 236 | 9.3 | 6.8 | 44.9 | 48.4 | .41 | 5 | \$12.98 | |
| 35019 | 21.0 x 23.0 | 250 | 9.8 | 7.3 | 47.4 | 51.5 | .58 | 5 | \$13.98 | |
| 35020 | 22.0 x 24.0 | 250 | 9.8 | 7.3 | 47.4 | 51.5 | .57 | 5 | \$14.98 | |
| 35021 | 24.0 x 26.0 | 265 | 10.4 | 7.8 | 52.5 | 58.6 | .70 | 5 | \$15.98 | |
| 35022 | 24.0 x 27.0 | 265 | 10.4 | 7.8 | 52.5 | 58.6 | .68 | 5 | \$16.98 | |
| 35023 | 25.0 x 28.0 | 280 | 11.0 | 8.1 | 55.2 | 61.3 | .77 | 1 | \$17.98 | |
| 35024 | 27.0 x 29.0 | 280 | 11.0 | 8.1 | 58.6 | 64.4 | .79 | 1 | \$20.98 | |
| 35025 | 27.0 x 30.0 | 280 | 11.0 | 8.1 | 58.6 | 64.4 | .78 | 1 | \$21.98 | |
| 35026 | 30.0 x 32.0 | 302 | 11.8 | 8.6 | 64.8 | 70.3 | 1.06 | 1 | \$22.98 | |
| 35027 | 32.0 x 36.0 | 325 | 12.7 | 8.8 | 66.5 | 74.5 | 1.21 | 1 | \$35.98 | |
| 35028 | 36.0 x 41.0 | 358 | 14.0 | 8.8 | 74.5 | 84.0 | 1.61 | 1 | \$48.98 | |
| 35029 | 46.0 x 50.0 | 450 | 17.6 | 10.8 | 93.5 | 105.0 | 3.23 | 1 | \$88.98 | |

350 Open End Wrenches Inch DIN 3110 / ISO 10102

Made from 31CRV3 high performance tool steel. Satin chromed sure grip body. Polished Head. Precision formed for exact fit.

| Item No. | Inch | Inch | OAL mm | OAL Inch | H mm | D ¹ mm | D ² mm | lbs. | pkg. | Each |
|----------|---------------|------|--------|----------|------|-------------------|-------------------|------|---------|------|
| 35032 | 1/4 x 5/16 | 190 | 7.5 | 5.7 | 32.5 | 34.9 | .20 | 10 | \$6.98 | |
| 35033 | 5/16 x 3/8 | 204 | 8.0 | 5.9 | 36.1 | 39.2 | .23 | 10 | \$6.98 | |
| 35034 | 3/8 x 7/16 | 236 | 9.3 | 6.8 | 44.9 | 48.4 | .45 | 10 | \$6.98 | |
| 35035 | 7/16 x 1/2 | 250 | 9.8 | 7.3 | 47.4 | 51.5 | .58 | 10 | \$6.98 | |
| 35036 | 1/2 x 9/16 | 190 | 7.5 | 5.7 | 32.5 | 34.9 | .20 | 10 | \$7.98 | |
| 35037 | 9/16 x 5/8 | 190 | 7.5 | 5.7 | 32.5 | 34.9 | .20 | 10 | \$8.98 | |
| 35038 | 19/32 x 11/16 | 204 | 8.0 | 5.9 | 36.1 | 29.2 | .24 | 10 | \$9.98 | |
| 35039 | 5/8 x 11/16 | 204 | 8.0 | 5.9 | 36.1 | 29.2 | .23 | 10 | \$9.98 | |
| 35040 | 5/8 x 3/4 | 223 | 8.7 | 6.5 | 40.2 | 42.3 | .34 | 5 | \$10.98 | |
| 35041 | 11/16 x 3/4 | 223 | 8.7 | 6.5 | 40.2 | 42.3 | .33 | 5 | \$11.98 | |
| 35042 | 3/4 x 25/32 | 236 | 9.3 | 6.8 | 44.9 | 48.4 | .42 | 5 | \$11.98 | |
| 35043 | 3/4 x 7/8 | 236 | 9.3 | 6.8 | 44.9 | 48.4 | .41 | 5 | \$12.98 | |
| 35044 | 13/16 x 7/8 | 236 | 9.3 | 6.8 | 44.9 | 48.4 | .40 | 5 | \$13.98 | |
| 35045 | 7/8 x 15/16 | 250 | 9.8 | 7.3 | 47.4 | 51.5 | .57 | 5 | \$14.98 | |
| 35046 | 15/16 x 1 | 265 | 10.4 | 7.8 | 52.5 | 58.6 | .68 | 5 | \$16.98 | |
| 35047 | 1 x 1-1/8 | 280 | 11.0 | 8.1 | 55.7 | 61.3 | .76 | 1 | \$17.98 | |
| 35048 | 1-1/16x1-1/4 | 302 | 11.8 | 8.6 | 59.7 | 69.9 | 1.01 | 1 | \$22.98 | |
| 35049 | 1-1/8x1-5/16 | 302 | 11.8 | 8.6 | 64.8 | 70.3 | 1.06 | 1 | \$24.98 | |
| 35050 | 1-3/16x1-5/16 | 302 | 11.8 | 8.6 | 64.8 | 70.3 | 1.03 | 1 | \$26.98 | |
| 35051 | 1-1/4 x 1-3/8 | 325 | 12.7 | 8.8 | 66.5 | 74.5 | 1.22 | 1 | \$44.98 | |
| 35052 | 1-5/16x1-1/2 | 325 | 12.7 | 8.8 | 66.5 | 74.5 | 1.19 | 1 | \$45.98 | |
| 35053 | 1-7/16x1-5/8 | 358 | 14.0 | 8.8 | 74.5 | 84.0 | 1.60 | 1 | \$56.98 | |
| 35054 | 1-1/2 x 1-5/8 | 358 | 14.0 | 8.8 | 74.5 | 84.0 | 1.56 | 1 | \$57.98 | |
| 35055 | 1-11/16x1-7/8 | 400 | 15.7 | 9.8 | 84.0 | 93.5 | 2.18 | 1 | \$72.98 | |
| 35056 | 1-13/16 x 2 | 450 | 17.6 | 10.8 | 93.5 | 105.0 | 3.22 | 1 | \$92.98 | |



Made in Germany

Toll Free: (800) 494-6104

Click image to view web page

Wiha Heyco Open End Wrenches



- Made from 31CRV3 high performance tool steel
- Satin chromed sure grip body
- Polished Head
- Precision formed for exact fit



- Made from 31CRV3 high performance tool steel
- Satin chromed sure grip body
- Polished Head
- Precision formed for exact fit



350 90 Set 12 Piece Metric Open End Wrenches

| | |
|--|-----------------------------------|
| Item No. 350 90 Includes: | |
| 4.0 x 5.0, 5.0 x 5.5, 6.0 x 7.0, 8.0 x 9.0, 10.0 x 11.0, 12.0 x 13.0, 14.0 x 15.0, 16.0 x 17.0, 18.0 x 19.0, 21.0 x 23.0, 20.0 x 22.0, 24.0 x 26.0 | lbs. 3.30 Each \$114.98 |

350 91 Set 11 Piece Inch Open End Wrenches In Tool Box

| | |
|---|-----------------------------------|
| Item No. 350 91 Includes: | |
| 1/4x5/16, 3/8x7/16, 7/16x1/2, 1/2x9/16, 5/8x11/16, 3/4x25/32, 13/16x7/8, 15/16x1, 1x1-1/8, 1-1/16x1-1/4, 1-1/8x1-15/16" | lbs. 8.92 Each \$144.98 |



350 92 Set 15 Piece Metric Open End Wrenches In tool box

| | |
|---|------------------------------------|
| Item No. 350 92 Includes: | |
| 6.0 x 7.0, 8.0 x 9.0, 10.0 x 11.0, 12.0 x 13.0, 14.0 x 15.0, 16.0 x 17.0, 18.0 x 19.0, 20.0 x 22.0, 21.0 x 23.0, 24.0 x 26.0, 25.0 x 28.0, 27.0 x 29.0, 30.0 x 32.0, 36.0 x 41.0, 46.0 x 50.0 | lbs. 15.00 Each \$299.98 |

350 93 Set 15 Piece Inch Open End Wrenches In tool box

| | |
|---|-----------------------------------|
| Item No. 350 93 Includes: | |
| 1/4x5/16, 3/8x7/16, 7/16x1/2, 1/2x9/16, 5/8x11/16, 3/4x25/32, 13/16x7/8, 15/16x1, 1x1-1/8, 1-1/16x1-1/4, 1-1/8x1-15/16, 1-5/16x1-1/2, 1-7/16x1-5/8, 1-11/16x1-7/8, 1-13/16x2" | lbs. 17.7 Each \$417.98 |

350 94 Set 10 Piece Metric Open End Wrenches

| | |
|--|-----------------------------------|
| Item No. 350 94 Includes: | |
| 6.0 x 7.0, 8.0 x 9.0, 10.0 x 11.0, 12.0 x 13.0, 14.0 x 15.0, 16.0 x 17.0, 18.0 x 19.0, 20.0 x 22.0, 21.0 x 23.0, 24.0 x 26.0 | lbs. 3.31 Each \$111.98 |

350 95 Set 10 Piece Inch Open End Wrenches In tool box

| | |
|---|-----------------------------------|
| Item No. 350 95 Includes: | |
| 3/8x7/16, 1/2x9/16, 5/8x11/16, 3/4x25/32, 13/16x7/8, 15/16x1, 1-1/16x1-1/4, 1-1/8x1-15/16, 1-1/4x1-3/8, 1-5/16x1-1/2" | lbs. 8.92 Each \$144.98 |



350 96 Set 7 Piece Metric Open End Wrenches

| | |
|---|---------------------|
| Item No. 350 96 Includes: | lbs. 1.50 |
| 6.0 x 7.0, 8.0 x 9.0, 10.0 x 11.0, 12.0 x 13.0, 14.0 x 15.0, 16.0 x 17.0, 18.0 x 19.0 | Each \$56.98 |

350 97 Set 7 Piece Inch Open End Wrenches

| | |
|---|---------------------|
| Item No. 350 97 Includes: | lbs. 2.55 |
| 1/4x5/16, 3/8x7/16, 1/2x9/16, 5/8x11/16, 3/4x25/32, 13/16x7/8, 15/16x1" | Each \$73.98 |



350 98 Set 5 Piece Metric Open End Wrenches

| | |
|---|---------------------|
| Item No. 350 98 Includes: | lbs. .55 |
| 4.0 x 5.0, 5.0 x 5.5, 6.0 x 7.0, 8.0 x 9.0, 10.0 x 11.0 | Each \$33.98 |

350 99 Set 5 Piece Inch Open End Wrenches

| | |
|--|---------------------|
| Item No. 350 99 Includes: | lbs. 2.55 |
| 3/8x7/16, 1/2x9/16, 9/16x5/8, 1/16x3/4, 13/16x7/8" | Each \$73.98 |



Made in Germany

www.wihatools.com

Click image to view web page

Wiha SoftGrip Wrenches

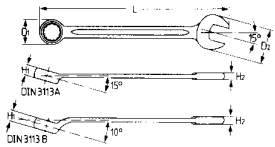

- Made from 31CRV3 high performance tool steel
- Soft grip body
- Polished Head
- Precision formed for exact fit

500 SoftGrip Wrenches Inch DIN 3113A/ISO 3318 - ISO 7738

| Item No. | AF | OAL | OAL | H ¹ | H ² | D ¹ | D ² | Weight | lbs. | pkg. | Each |
|----------|--------|-----|------|----------------|----------------|----------------|----------------|--------|------|------|---------|
| | mm | mm | Inch | mm | mm | mm | mm | | | | |
| 500 43 | 1/4 | 100 | 3.9 | 5.0 | 3.9 | 10.1 | 15.7 | .03 | 10 | | \$10.98 |
| 500 44 | 5/16 | 120 | 4.7 | 5.9 | 4.4 | 12.9 | 19.0 | .05 | 10 | | \$10.98 |
| 500 45 | 3/8 | 140 | 5.5 | 6.9 | 5.0 | 15.9 | 22.8 | .09 | 10 | | \$11.98 |
| 500 46 | 7/16 | 150 | 5.9 | 7.4 | 5.2 | 17.3 | 25.4 | .11 | 10 | | \$11.98 |
| 500 47 | 1/2 | 170 | 6.7 | 8.4 | 5.8 | 20.2 | 29.3 | .14 | 10 | | \$12.98 |
| 500 48 | 9/16 | 180 | 7.1 | 8.9 | 6.1 | 21.6 | 31.2 | .19 | 10 | | \$13.98 |
| 500 50 | 5/8 | 200 | 7.8 | 9.8 | 6.6 | 24.6 | 34.5 | .23 | 10 | | \$14.98 |
| 500 51 | 11/16 | 210 | 8.2 | 10.3 | 6.9 | 25.9 | 37.3 | .30 | 10 | | \$16.98 |
| 500 52 | 3/4 | 230 | 9.0 | 11.1 | 7.3 | 28.8 | 40.4 | .34 | 5 | | \$18.98 |
| 500 54 | 13/16 | 250 | 9.8 | 11.7 | 7.7 | 31.7 | 44.2 | .45 | 5 | | \$20.98 |
| 500 55 | 7/8 | 260 | 10.2 | 12.0 | 7.9 | 33.0 | 46.6 | .51 | 5 | | \$22.98 |
| 500 56 | 15/16 | 280 | 11.0 | 12.7 | 8.3 | 35.8 | 50.1 | .63 | 1 | | \$25.98 |
| 500 57 | 1 | 290 | 11.4 | 13.0 | 8.5 | 37.3 | 52.8 | .65 | 1 | | \$26.98 |
| 500 58 | 1-1/16 | 310 | 12.2 | 13.6 | 8.9 | 40.2 | 55.9 | .83 | 1 | | \$33.98 |
| 500 59 | 1-1/8 | 330 | 13.0 | 14.2 | 9.3 | 42.8 | 59.8 | .98 | 1 | | \$36.98 |

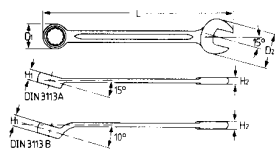

- Made from 31CRV3 high performance tool steel
- Soft grip body
- Polished Head
- Precision formed for exact fit

500 SoftGrip Wrenches Metric DIN 3113A/ISO 3318 - ISO 7738

| Item No. | MM | OAL | OAL | H ¹ | H ² | D ¹ | D ² | Weight | lbs. | pkg. | Each |
|----------|------|-----|------|----------------|----------------|----------------|----------------|--------|------|------|---------|
| | mm | mm | Inch | mm | mm | mm | mm | | | | |
| 500 04 | 8.0 | 120 | 4.7 | 5.9 | 4.4 | 12.9 | 19.0 | .05 | 10 | | \$10.98 |
| 500 05 | 9.0 | 130 | 5.1 | 6.4 | 4.7 | 14.5 | 20.9 | .07 | 10 | | \$10.98 |
| 500 06 | 10.0 | 140 | 5.5 | 6.9 | 5.0 | 15.9 | 22.8 | .09 | 10 | | \$11.98 |
| 500 07 | 11.0 | 150 | 5.9 | 7.4 | 5.2 | 17.3 | 25.4 | .11 | 10 | | \$11.98 |
| 500 08 | 12.0 | 160 | 6.3 | 7.9 | 5.5 | 18.7 | 26.7 | .13 | 10 | | \$11.98 |
| 500 09 | 13.0 | 170 | 6.7 | 8.4 | 5.8 | 20.2 | 29.3 | .14 | 10 | | \$12.98 |
| 500 11 | 14.0 | 180 | 7.1 | 8.9 | 6.1 | 21.6 | 31.2 | .19 | 10 | | \$13.98 |
| 500 12 | 15.0 | 190 | 7.5 | 9.3 | 6.3 | 23.1 | 33.0 | .21 | 10 | | \$14.98 |
| 500 13 | 16.0 | 200 | 7.8 | 9.8 | 6.6 | 24.6 | 34.5 | .23 | 10 | | \$15.98 |
| 500 14 | 17.0 | 210 | 8.2 | 10.3 | 6.9 | 25.4 | 37.3 | .30 | 10 | | \$16.98 |
| 500 15 | 18.0 | 220 | 8.6 | 10.8 | 7.1 | 27.4 | 38.4 | .32 | 10 | | \$17.98 |
| 500 16 | 19.0 | 230 | 9.0 | 11.1 | 7.3 | 28.8 | 40.4 | .34 | 10 | | \$17.98 |
| 500 17 | 20.0 | 240 | 9.4 | 11.4 | 7.5 | 30.2 | 42.3 | .39 | 5 | | \$19.98 |
| 500 19 | 22.0 | 260 | 10.2 | 12.0 | 7.9 | 33.0 | 46.6 | .51 | 5 | | \$22.98 |
| 500 27 | 24.0 | 280 | 11.0 | 12.7 | 8.3 | 35.8 | 50.1 | .62 | 5 | | \$26.98 |



500 89 Set 15 Piece Inch Combination Wrenches Roll up pouch

| | |
|---|----------|
| Item No. 500 89 Includes: | Each |
| 1/4, 5/16, 3/8, 7/16, 1/2, 9/16, 5/8, 11/16, 3/4, 13/16, 7/8, 15/16, 1, 1-1/16, 1-1/8 | \$293.98 |



500 95 Set 10 Piece Inch Combination Wrenches Roll up pouch

| | |
|--|---------------|
| Item No. 500 95: 7/16, 1/2, 9/16, 5/8, 11/16, 3/4, 13/16, 7/8, 15/16, 1" | Each \$185.98 |
|--|---------------|



500 91 Set 12 Piece Inch Combination Wrenches Roll up pouch

| | |
|--|----------|
| Item No. 500 91 Includes: | Each |
| 5/16, 3/8, 7/16, 1/2, 9/16, 5/8, 11/16, 3/4, 13/16, 7/8, 15/16, 1" | \$208.98 |



500 87 Set 15 Piece Inch Combination Wrenches Roll up pouch

| | |
|--|----------|
| Item No. 500 87 Includes: | Each |
| 8, 9, 10, 11, 12, 13, 14, 15, 16, 17, 18, 19, 20, 22, 24mm | \$237.98 |



500 94 Set 10 Piece Inch Combination Wrenches Roll up pouch

| | |
|--|---------------|
| Item No. 500 94 Includes: 10, 11, 12, 13, 14, 15, 16, 17, 18, 19mm | Each \$145.98 |
|--|---------------|



500 88 Set 12 Piece Inch Combination Wrenches Roll up pouch

| | |
|--|---------------|
| Item No. 500 88 Includes: 8, 9, 10, 11, 12, 13, 14, 15, 16, 17, 18, 19mm | Each \$167.98 |
|--|---------------|



Made in Germany

Toll Free: (800) 494-6104

Click image to view web page

Wiha Combination Wrenches

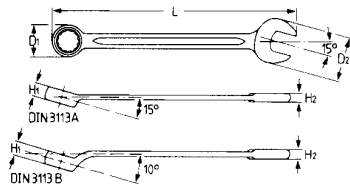

400 Combination Wrenches Inch DIN 3113A/ISO 3318 - ISO 7738

Made from 31CRV3 high performance tool steel. Satin chromed sure grip body. Polished Head. Precision formed for exact fit.

| Item No. | AF | OAL | OAL | H ¹ | H ² | D ¹ | D ² | ↵ | Ⓜ | Each |
|----------|---------|-----|------|----------------|----------------|----------------|----------------|------|------|----------|
| | mm | mm | Inch | mm | mm | mm | mm | lbs. | pkg. | |
| 400 43 | 1/4 | 100 | 3.9 | 5.0 | 3.9 | 10.1 | 15.7 | .03 | 10 | \$6.98 |
| 400 44 | 5/16 | 120 | 4.7 | 5.9 | 4.4 | 12.9 | 19.0 | .05 | 10 | \$6.98 |
| 400 45 | 3/8 | 140 | 5.5 | 6.9 | 5.0 | 15.9 | 22.8 | .09 | 10 | \$7.98 |
| 400 46 | 7/16 | 150 | 5.9 | 7.4 | 5.2 | 17.3 | 25.4 | .11 | 10 | \$7.98 |
| 400 47 | 1/2 | 170 | 6.7 | 8.4 | 5.8 | 20.2 | 29.3 | .14 | 10 | \$8.98 |
| 400 48 | 9/16 | 180 | 7.1 | 8.9 | 6.1 | 21.6 | 31.2 | .19 | 10 | \$9.98 |
| 400 49 | 19/32 | 190 | 7.5 | 9.3 | 6.3 | 23.1 | 33.0 | .21 | 10 | \$11.98 |
| 400 50 | 5/8 | 200 | 7.8 | 9.8 | 6.6 | 24.6 | 34.5 | .23 | 10 | \$11.98 |
| 400 51 | 11/16 | 210 | 8.2 | 10.3 | 6.9 | 25.9 | 37.3 | .30 | 10 | \$12.98 |
| 400 52 | 3/4 | 230 | 9.0 | 11.1 | 7.3 | 28.8 | 40.4 | .34 | 5 | \$14.98 |
| 400 53 | 25/32 | 240 | 9.4 | 11.4 | 7.5 | 30.2 | 42.3 | .39 | 5 | \$16.98 |
| 400 54 | 13/16 | 250 | 9.8 | 11.7 | 7.7 | 31.7 | 44.2 | .45 | 5 | \$17.98 |
| 400 55 | 7/8 | 260 | 10.2 | 12.0 | 7.9 | 33.0 | 46.6 | .51 | 5 | \$18.98 |
| 400 56 | 15/16 | 280 | 11.0 | 12.7 | 8.3 | 35.8 | 50.1 | .63 | 5 | \$21.98 |
| 400 57 | 1 | 290 | 11.4 | 13.0 | 8.5 | 37.3 | 52.8 | .65 | 1 | \$23.98 |
| 400 58 | 1-1/16 | 310 | 12.2 | 13.6 | 8.9 | 40.2 | 55.9 | .83 | 1 | \$28.98 |
| 400 59 | 1-1/8 | 330 | 13.0 | 14.2 | 9.3 | 42.8 | 59.8 | .98 | 1 | \$33.98 |
| 400 60 | 1-1/4 | 360 | 14.1 | 15.2 | 9.9 | 47.2 | 66.9 | 1.31 | 1 | \$33.98 |
| 400 61 | 1-5/16 | 360 | 14.1 | 15.2 | 9.9 | 47.2 | 66.9 | 1.28 | 1 | \$35.98 |
| 400 62 | 1-3/8 | 400 | 15.7 | 22.8 | 14.1 | 54.6 | 77.5 | 2.56 | 1 | \$55.98 |
| 400 63 | 1-7/16 | 400 | 15.7 | 22.8 | 14.1 | 54.6 | 77.5 | 2.38 | 1 | \$56.98 |
| 400 64 | 1-1/2 | 400 | 15.7 | 22.8 | 14.1 | 54.6 | 77.5 | 2.33 | 1 | \$57.98 |
| 400 65 | 1-5/8 | 450 | 17.6 | 25.8 | 15.8 | 62.1 | 83.7 | 3.19 | 1 | \$69.98 |
| 400 66 | 1-3/4 | 500 | 19.6 | 28.8 | 17.5 | 69.6 | 93.1 | 4.44 | 1 | \$104.98 |
| 400 67 | 1-13/16 | 500 | 19.6 | 28.8 | 17.5 | 69.6 | 93.1 | 4.31 | 1 | \$104.98 |
| 400 68 | 2 | 540 | 21.2 | 31.2 | 18.9 | 75.6 | 102.6 | 5.72 | 1 | \$130.98 |

400 89 Set 15 Piece Inch Combination Wrenches Made from

31CRV3 high performance tool steel. Satin chromed sure grip body. Polished Head. Precision formed for exact fit. In roll up pouch.

| Item No. | OAL | OAL |
|----------|--------|------|
| | Inch | Inch |
| 400 43 | 1/4 | 100 |
| 400 44 | 5/16 | 120 |
| 400 45 | 3/8 | 140 |
| 400 46 | 7/16 | 150 |
| 400 47 | 1/2 | 170 |
| 400 48 | 9/16 | 180 |
| 400 50 | 5/8 | 200 |
| 400 51 | 11/16 | 210 |
| 400 52 | 3/4 | 230 |
| 400 54 | 13/16 | 250 |
| 400 55 | 7/8 | 260 |
| 400 56 | 15/16 | 280 |
| 400 57 | 1 | 290 |
| 400 58 | 1-1/16 | 310 |
| 400 59 | 1-1/8 | 330 |
| \$230.98 | | |



400 91 Set 12 Piece Inch Combination Wrenches

Made from 31CRV3 high performance tool steel. Satin chromed sure grip body. Polished Head. Precision formed for exact fit. In roll up pouch

| Item No. | OAL | OAL |
|----------|-------|------|
| | Inch | Inch |
| 400 44 | 5/16 | 120 |
| 400 45 | 3/8 | 140 |
| 400 46 | 7/16 | 150 |
| 400 47 | 1/2 | 170 |
| 400 48 | 9/16 | 180 |
| 400 50 | 5/8 | 200 |
| 400 51 | 11/16 | 210 |
| 400 52 | 3/4 | 230 |
| 400 54 | 13/16 | 250 |
| 400 55 | 7/8 | 260 |
| 400 56 | 15/16 | 280 |
| 400 57 | 1 | 290 |
| \$169.00 | | |



Made in Germany

www.wihatools.com

Click image to view web page

Wiha Combination Wrenches



400 93 Set 7 Piece Inch Combination Wrenches

Made from 31CRV3 high performance tool steel. Satin chromed sure grip body. Polished Head. Precision formed for exact fit.

| Item No. | OAL | | OAL | |
|----------|--------|----------|---------------------|-----------|
| | Inch | mm | Inch | mm |
| 400 93 | 400 45 | 3/8 140 | 400 50 | 5/8 200 |
| | 400 46 | 7/16 150 | 400 51 | 11/16 210 |
| lbs. | 400 47 | 1/2 170 | 400 52 | 3/4 230 |
| 1.60 | 400 48 | 9/16 180 | Each \$74.98 | |



400 97 Set 15 Piece Inch Combination Wrenches Made from 31CRV3 high performance tool steel. Satin chromed sure grip body. Polished Head. Precision formed for exact fit. In molded tool box.

| Item No. | OAL | | OAL | |
|-----------------|--------|-----------|--------|------------|
| | Inch | mm | Inch | mm |
| 400 97 | 400 44 | 5/16 120 | 400 54 | 13/16 250 |
| | 400 45 | 3/8 140 | 400 55 | 7/8 260 |
| | 400 46 | 7/16 150 | 400 56 | 15/16 280 |
| | 400 47 | 1/2 170 | 400 57 | 1 290 |
| lbs. | 400 48 | 9/16 180 | 400 58 | 1-1/16 310 |
| 11.0 | 400 50 | 5/8 200 | 400 59 | 1-1/8 330 |
| Each | 400 51 | 11/16 210 | 400 60 | 1-1/4 360 |
| \$259.98 | 400 52 | 3/4 230 | | |



400 95 Set 10 Piece Inch Combination Wrenches In roll up pouch

| Item No. | OAL | | OAL | |
|-----------------|--------|-----------|--------|-----------|
| | Inch | mm | Inch | mm |
| 400 95 | 400 46 | 7/16 150 | 400 52 | 3/4 230 |
| | 400 47 | 1/2 170 | 400 54 | 13/16 250 |
| lbs. 7.50 | 400 48 | 9/16 180 | 400 55 | 7/8 260 |
| Each | 400 50 | 5/8 200 | 400 56 | 15/16 280 |
| \$153.00 | 400 51 | 11/16 210 | 400 57 | 1 290 |



400 99 Set 26 Piece Inch Combination Wrenches With Tool Box

Made from 31CRV3 high performance tool steel. Satin chromed sure grip body. Polished Head. Precision formed for exact fit.

| Item No. | OAL | | OAL | |
|-----------------|--------|-----------|--------|-------------|
| | Inch | mm | Inch | mm |
| 400 99 | 400 43 | 1/4 100 | 400 56 | 15/16 280 |
| | 400 44 | 5/16 120 | 400 57 | 1 290 |
| | 400 45 | 3/8 140 | 400 58 | 1-1/16 310 |
| | 400 46 | 7/16 150 | 400 59 | 1-1/8 330 |
| | 400 47 | 1/2 170 | 400 60 | 1-1/4 360 |
| | 400 48 | 9/16 180 | 400 61 | 1-5/16 360 |
| | 400 49 | 19/32 190 | 400 62 | 1-3/8 400 |
| | 400 50 | 5/8 200 | 400 63 | 1-7/16 400 |
| | 400 51 | 11/16 210 | 400 64 | 1-1/2 400 |
| lbs. | 400 52 | 3/4 230 | 400 65 | 1-5/8 450 |
| 38.5 | 400 53 | 25/32 240 | 400 66 | 1-3/4 500 |
| Each | 400 54 | 13/16 250 | 400 67 | 1-13/16 500 |
| \$899.98 | 400 55 | 7/8 260 | 400 68 | 2 540 |



Made in Germany

Toll Free: (800) 494-6104

Click image to view web page

Wiha Combination Wrenches

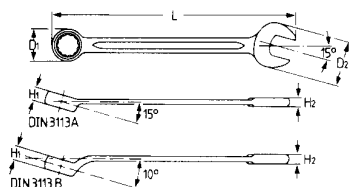

400 Combination Wrenches Metric DIN 3113A/ISO 3318 - ISO 7738

Made from 31CRV3 high performance tool steel. Satin chromed sure grip body. Polished Head. Precision formed for exact fit.

| Item No. | mm | OAL mm | OAL Inch | H1 mm | H2 mm | D ¹ mm | D ² mm | lbs. | pkg. | Each |
|----------|------|--------|----------|-------|-------|-------------------|-------------------|------|------|----------|
| 400 01 | 5.5 | 100 | 3.9 | 5.0 | 3.0 | 10.1 | 15.7 | .03 | 10 | \$6.98 |
| 400 02 | 6.0 | 100 | 3.9 | 5.0 | 3.9 | 10.1 | 15.7 | .03 | 10 | \$6.98 |
| 400 03 | 7.0 | 110 | 4.3 | 5.5 | 4.2 | 11.5 | 17.0 | .04 | 10 | \$6.98 |
| 400 04 | 8.0 | 120 | 4.7 | 5.9 | 4.4 | 12.9 | 19.0 | .05 | 10 | \$7.98 |
| 400 05 | 9.0 | 130 | 5.1 | 6.4 | 4.7 | 14.5 | 20.9 | .07 | 10 | \$7.98 |
| 400 06 | 10.0 | 140 | 5.5 | 6.9 | 5.0 | 15.9 | 22.8 | .09 | 10 | \$8.98 |
| 400 07 | 11.0 | 150 | 5.9 | 7.4 | 5.2 | 17.3 | 25.4 | .11 | 10 | \$8.98 |
| 400 08 | 12.0 | 160 | 6.3 | 7.9 | 5.5 | 18.7 | 26.7 | .13 | 10 | \$8.98 |
| 400 09 | 13.0 | 170 | 6.7 | 8.4 | 5.8 | 20.2 | 29.3 | .14 | 10 | \$9.98 |
| 400 11 | 14.0 | 180 | 7.1 | 8.9 | 6.1 | 21.6 | 31.2 | .19 | 10 | \$10.98 |
| 400 12 | 15.0 | 190 | 7.5 | 9.3 | 6.3 | 23.1 | 33.0 | .21 | 10 | \$11.98 |
| 400 13 | 16.0 | 200 | 7.8 | 9.8 | 6.6 | 24.6 | 34.5 | .23 | 10 | \$11.98 |
| 400 14 | 17.0 | 210 | 8.2 | 10.3 | 6.9 | 25.4 | 37.3 | .30 | 10 | \$12.98 |
| 400 15 | 18.0 | 220 | 8.6 | 10.8 | 7.1 | 27.4 | 38.4 | .32 | 10 | \$13.98 |
| 400 16 | 19.0 | 230 | 9.0 | 11.1 | 7.3 | 28.8 | 40.4 | .34 | 10 | \$13.98 |
| 400 17 | 20.0 | 240 | 9.4 | 11.4 | 7.5 | 30.2 | 42.3 | .39 | 5 | \$15.98 |
| 400 18 | 21.0 | 250 | 9.8 | 11.7 | 7.7 | 31.7 | 44.2 | .44 | 5 | \$17.98 |
| 400 19 | 22.0 | 260 | 10.2 | 12.0 | 7.9 | 33.0 | 46.6 | .51 | 5 | \$18.98 |
| 400 20 | 23.0 | 270 | 10.6 | 12.4 | 8.1 | 34.5 | 48.8 | .56 | 5 | \$19.98 |
| 400 27 | 24.0 | 280 | 11.0 | 12.7 | 8.3 | 35.8 | 50.1 | .62 | 5 | \$22.98 |
| 400 28 | 25.0 | 290 | 11.4 | 13.0 | 8.5 | 37.3 | 52.8 | .66 | 1 | \$24.98 |
| 400 29 | 26.0 | 300 | 11.8 | 13.3 | 8.7 | 38.7 | 53.9 | .74 | 1 | \$24.98 |
| 400 30 | 27.0 | 310 | 12.2 | 13.6 | 8.9 | 40.2 | 55.9 | .83 | 1 | \$29.98 |
| 400 31 | 28.0 | 320 | 12.5 | 13.9 | 9.1 | 41.5 | 57.8 | .88 | 1 | \$30.98 |
| 400 32 | 29.0 | 330 | 12.9 | 14.2 | 9.3 | 42.8 | 59.8 | .97 | 1 | \$31.98 |
| 400 33 | 30.0 | 340 | 13.3 | 14.6 | 9.5 | 44.3 | 62.6 | 1.08 | 1 | \$32.98 |
| 400 34 | 32.0 | 360 | 14.1 | 15.2 | 9.9 | 47.2 | 66.9 | 1.30 | 1 | \$33.98 |
| 400 35 | 34.0 | 380 | 14.9 | 15.8 | 10.3 | 50.1 | 69.5 | 1.50 | 1 | \$38.98 |
| 400 36 | 36.0 | 400 | 15.7 | 22.8 | 14.1 | 54.6 | 77.5 | 2.40 | 1 | \$55.98 |
| 400 37 | 38.0 | 400 | 15.7 | 22.8 | 14.1 | 54.6 | 77.5 | 2.35 | 1 | \$65.98 |
| 400 38 | 41.0 | 450 | 17.6 | 25.8 | 15.8 | 62.1 | 83.7 | 3.19 | 1 | \$67.98 |
| 400 39 | 46.0 | 500 | 19.6 | 28.8 | 17.5 | 69.6 | 93.1 | 4.31 | 1 | \$105.98 |
| 400 40 | 50.0 | 540 | 21.1 | 31.2 | 18.9 | 75.6 | 102.6 | 5.72 | 1 | \$122.98 |

400 87 Set 15 Piece Metric Combination Wrenches Made from

31CRV3 high performance tool steel. Satin chromed sure grip body.

Polished Head. Precision formed for exact fit. In roll up pouch

| Item No. | OAL mm | OAL mm | | |
|----------|--------|----------|--------|----------|
| 400 87 | 400 04 | 8.0 120 | 400 13 | 16.0 200 |
| | 400 05 | 9.0 130 | 400 14 | 17.0 210 |
| | 400 06 | 10.0 140 | 400 15 | 18.0 220 |
| | 400 07 | 11.0 150 | 400 16 | 19.0 230 |
| lbs. | 400 08 | 12.0 160 | 400 17 | 20.0 240 |
| 6.75 | 400 09 | 13.0 170 | 400 19 | 22.0 260 |
| Each | 400 11 | 14.0 180 | 400 27 | 24.0 280 |
| \$188.98 | 400 12 | 15.0 190 | | |



400 92 Set 26 Piece Metric Combination Wrenches In tool box

| Item No. | OAL mm | OAL mm | | |
|----------|--------|----------|--------|----------|
| 400 92 | 400 02 | 6.0 100 | 400 16 | 19.0 230 |
| | 400 03 | 7.0 110 | 400 17 | 20.0 240 |
| | 400 04 | 8.0 120 | 400 18 | 21.0 250 |
| | 400 05 | 9.0 130 | 400 19 | 22.0 260 |
| | 400 06 | 10.0 140 | 400 20 | 23.0 270 |
| | 400 07 | 11.0 150 | 400 27 | 24.0 280 |
| | 400 08 | 12.0 160 | 400 28 | 25.0 290 |
| | 400 09 | 13.0 170 | 400 29 | 26.0 300 |
| | 400 11 | 14.0 180 | 400 30 | 27.0 310 |
| lbs. | 400 12 | 15.0 190 | 400 31 | 28.0 320 |
| 15.3 | 400 13 | 16.0 200 | 400 32 | 29.0 330 |
| Each | 400 14 | 17.0 210 | 400 33 | 30.0 340 |
| \$448.98 | 400 15 | 18.0 220 | 400 34 | 32.0 360 |



Made in Germany

www.wihatools.com

Click image to view web page

Wiha Combination Wrenches



400 96 Set 15 Piece Metric Combination Wrenches Made from 31CRV3 high performance tool steel. Satin chromed sure grip body. Polished Head. Precision formed for exact fit. In Molded tool box

| Item No. | OAL | | OAL | |
|-----------------|--------|----------|--------|----------|
| | mm | mm | mm | mm |
| 400 96 | 400 03 | 7.0 110 | 400 12 | 15.0 190 |
| | 400 04 | 8.0 120 | 400 13 | 16.0 200 |
| | 400 05 | 9.0 130 | 400 14 | 17.0 210 |
| | 400 06 | 10.0 140 | 400 15 | 18.0 220 |
| lbs. | 400 07 | 11.0 150 | 400 16 | 19.0 230 |
| 6.75 | 400 08 | 12.0 160 | 400 17 | 20.0 240 |
| Each | 400 09 | 13.0 170 | 400 18 | 21.0 250 |
| \$169.98 | 400 11 | 14.0 180 | | |

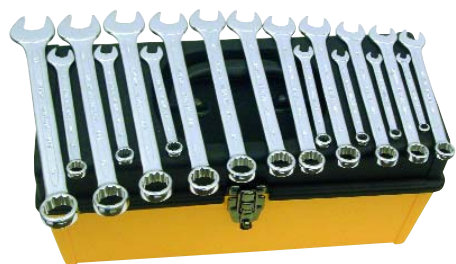

400 98 Set 18 Piece Metric Combination Wrenches In tool box Made from 31CRV3 high performance tool steel. Satin chromed sure grip body. Polished Head. Precision formed for exact fit.

| Item No. | OAL | | OAL | |
|-----------------|--------|----------|--------|----------|
| | mm | mm | mm | mm |
| 400 98 | 400 03 | 7.0 110 | 400 13 | 16.0 200 |
| | 400 04 | 8.0 120 | 400 14 | 17.0 210 |
| | 400 05 | 9.0 130 | 400 15 | 18.0 220 |
| | 400 06 | 10.0 140 | 400 16 | 19.0 230 |
| | 400 07 | 11.0 150 | 400 17 | 20.0 240 |
| lbs. | 400 08 | 12.0 160 | 400 18 | 21.0 250 |
| 8.7 | 400 09 | 13.0 170 | 400 19 | 22.0 260 |
| Each | 400 11 | 14.0 180 | 400 20 | 23.0 270 |
| \$231.98 | 400 12 | 15.0 190 | 400 27 | 24.0 280 |



400 86 Set 9 Piece Metric Combination Wrenches

Made from 31CRV3 high performance tool steel. Polished Head.

| Item No. | OAL | | OAL | |
|----------------|--------|----------|--------|----------|
| | mm | mm | mm | mm |
| 400 86 | 400 03 | 7.0 110 | 400 08 | 12.0 160 |
| | 400 04 | 8.0 120 | 400 09 | 13.0 170 |
| lbs. 1.3 | 400 05 | 9.0 130 | 400 11 | 14.0 180 |
| Each | 400 06 | 10.0 140 | 400 12 | 15.0 190 |
| \$81.98 | 400 07 | 11.0 150 | | |



400 88 Set 14 Piece Metric Combination Wrenches Made from 31CRV3 high performance tool steel. Satin chromed sure grip body. Polished Head. Precision formed for exact fit. In pouch

| Item No. | OAL | | OAL | |
|-----------------|--------|----------|--------|----------|
| | mm | mm | mm | mm |
| 400 96 | 400 02 | 6.0 100 | 400 09 | 13.0 170 |
| | 400 03 | 7.0 110 | 400 11 | 14.0 180 |
| | 400 04 | 8.0 120 | 400 12 | 15.0 190 |
| lbs. | 400 05 | 9.0 130 | 400 13 | 16.0 200 |
| 2.3 | 400 06 | 10.0 140 | 400 14 | 17.0 210 |
| Each | 400 07 | 11.0 150 | 400 15 | 18.0 220 |
| \$130.00 | 400 08 | 12.0 160 | 400 16 | 19.0 230 |



400 94 Set 10 Piece Metric Combination Wrenches

Made from 31CRV3 high performance tool steel. Satin chromed sure grip body. Polished Head. Precision formed for exact fit. In pouch

| Item No. | OAL | | OAL | |
|-----------------|--------|----------|--------|----------|
| | mm | mm | mm | mm |
| 400 94 | 400 06 | 10.0 140 | 400 12 | 15.0 190 |
| | 400 07 | 11.0 150 | 400 13 | 16.0 200 |
| lbs. 2.3 | 400 08 | 12.0 160 | 400 14 | 17.0 210 |
| Each | 400 09 | 13.0 170 | 400 15 | 18.0 220 |
| \$114.00 | 400 11 | 14.0 180 | 400 16 | 19.0 230 |



Made in Germany

Toll Free: (800) 494-6104

Click image to view web page

Wiha Box Wrenches

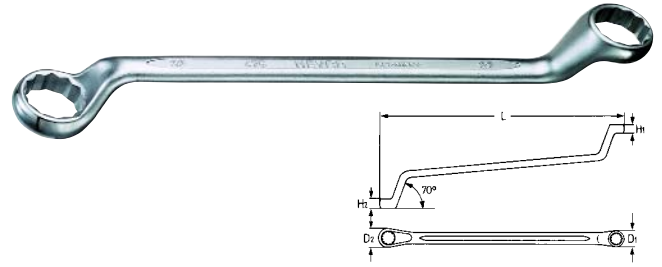
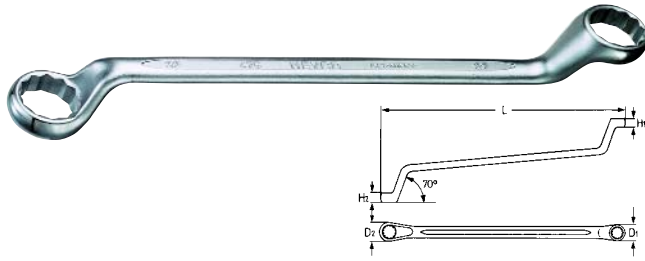

475 Box Wrenches Metric DIN 838 / ISO 10104

Satin chromed sure grip body. Made from 31CRV3 high performance forged tool steel. Precision formed for an exact fit. Polished head and ring. 12 point drive.

| Item No. | mm | mm | OAL mm | OAL Inch | H ¹ mm | H mm | D ¹ mm | D ² mm | lbs. | pkg. | Each |
|----------|-------------|-----|--------|----------|-------------------|------|-------------------|-------------------|------|----------|------|
| 475 01 | 5.5 x 7.0 | 165 | 6.5 | 5.8 | 6.3 | 10.6 | 12.2 | .09 | 10 | \$9.98 | |
| 475 02 | 6.0 x 7.0 | 165 | 6.5 | 5.8 | 6.3 | 10.6 | 12.2 | .09 | 10 | \$9.98 | |
| 475 41 | 7.0 x 8.0 | 170 | 6.7 | 6.0 | 6.7 | 12.2 | 13.5 | .12 | 10 | \$9.98 | |
| 475 03 | 8.0 x 9.0 | 180 | 7.1 | 6.7 | 7.3 | 13.7 | 15.1 | .13 | 10 | \$9.98 | |
| 475 04 | 10.0 x 11.0 | 195 | 7.6 | 7.5 | 8.1 | 16.4 | 17.9 | .19 | 10 | \$10.98 | |
| 475 05 | 12.0 x 13.0 | 216 | 8.5 | 8.4 | 9.0 | 19.7 | 20.9 | .26 | 10 | \$11.98 | |
| 475 06 | 14.0 x 15.0 | 238 | 9.3 | 9.6 | 10.1 | 22.4 | 25.0 | .33 | 10 | \$12.98 | |
| 475 07 | 16.0 x 17.0 | 262 | 10.3 | 10.2 | 10.4 | 25.4 | 27.0 | .44 | 10 | \$13.98 | |
| 475 08 | 18.0 x 19.0 | 290 | 11.4 | 10.8 | 11.0 | 27.8 | 29.7 | .55 | 5 | \$15.98 | |
| 475 09 | 20.0 x 22.0 | 320 | 12.5 | 11.5 | 12.2 | 31.8 | 34.0 | .75 | 5 | \$17.98 | |
| 475 10 | 21.0 x 23.0 | 326 | 12.8 | 11.8 | 12.5 | 32.4 | 35.3 | .77 | 5 | \$20.98 | |
| 475 11 | 24.0 x 26.0 | 337 | 13.2 | 12.8 | 13.9 | 37.0 | 41.0 | .92 | 5 | \$24.98 | |
| 475 12 | 25.0 x 28.0 | 346 | 13.6 | 13.0 | 14.2 | 29.2 | 43.0 | 1.1 | 1 | \$25.98 | |
| 475 13 | 27.0 x 29.0 | 346 | 13.6 | 13.9 | 14.6 | 40.5 | 45.3 | 1.1 | 1 | \$31.98 | |
| 475 14 | 30.0 x 32.0 | 360 | 14.1 | 13.9 | 15.5 | 45.5 | 49.0 | 1.3 | 1 | \$31.98 | |
| 475 15 | 30.0 x 34.0 | 380 | 14.9 | 14.8 | 16.5 | 45.5 | 51.8 | 1.3 | 1 | \$33.98 | |
| 475 16 | 36.0 x 41.0 | 440 | 17.3 | 18.0 | 19.5 | 53.5 | 60.5 | 2.5 | 1 | \$58.98 | |
| 475 17 | 46.0 x 50.0 | 500 | 19.6 | 21.4 | 22.4 | 67.0 | 73.0 | 3.6 | 1 | \$117.98 | |

475 Box Wrenches Inch DIN 838 / ISO 10104

Satin chromed sure grip body. Made from 31CRV3 high performance forged tool steel. Precision formed for an exact fit. Polished head and ring. 12 point drive.

| Item No. | Inch | Inch | OAL mm | OAL Inch | H ¹ mm | H mm | D ¹ mm | D ² mm | lbs. | pkg. | Each |
|----------|---------------|------|--------|----------|-------------------|------|-------------------|-------------------|------|----------|------|
| 475 18 | 1/4x5/16 | 170 | 6.7 | 6.0 | 6.7 | 12.2 | 13.5 | .12 | 10 | \$11.98 | |
| 475 19 | 5/16x3/8 | 180 | 7.1 | 6.7 | 7.5 | 13.7 | 16.4 | .14 | 10 | \$11.98 | |
| 475 20 | 3/8x7/16 | 195 | 7.6 | 7.5 | 8.1 | 16.4 | 17.9 | .19 | 10 | \$12.98 | |
| 475 21 | 7/16x1/2 | 216 | 8.5 | 8.4 | 9.0 | 18.3 | 20.9 | .24 | 10 | \$13.98 | |
| 475 22 | 1/2x9/16 | 239 | 9.4 | 9.0 | 9.3 | 20.9 | 22.3 | .32 | 10 | \$13.98 | |
| 475 23 | 9/16x5/8 | 239 | 9.4 | 9.3 | 9.7 | 22.3 | 25.0 | .32 | 10 | \$13.98 | |
| 475 24 | 5/8x11/16 | 262 | 10.3 | 10.2 | 10.4 | 25.4 | 27.0 | .42 | 10 | \$14.98 | |
| 475 25 | 5/8x3/4 | 290 | 11.4 | 10.2 | 11.0 | 25.4 | 29.7 | .51 | 10 | \$16.98 | |
| 475 26 | 11/16x3/4 | 290 | 11.4 | 10.8 | 11.0 | 27.8 | 29.7 | .58 | 5 | \$16.98 | |
| 475 27 | 3/4x25/32 | 290 | 11.4 | 11.0 | 11.4 | 29.7 | 31.8 | .57 | 5 | \$16.98 | |
| 475 28 | 3/4x7/8 | 320 | 12.5 | 11.0 | 12.2 | 29.7 | 34.0 | .67 | 5 | \$19.98 | |
| 475 29 | 13/16x7/8 | 320 | 12.5 | 11.5 | 12.2 | 31.8 | 34.0 | .69 | 5 | \$20.98 | |
| 475 30 | 7/8x15/16 | 326 | 12.8 | 12.2 | 12.8 | 34.0 | 37.0 | .77 | 5 | \$22.98 | |
| 475 31 | 15/16x1 | 337 | 13.2 | 12.8 | 13.9 | 37.0 | 41.0 | .98 | 1 | \$26.98 | |
| 475 32 | 1x1-1/8 | 346 | 13.6 | 13.0 | 14.2 | 39.2 | 43.0 | 1.1 | 1 | \$27.98 | |
| 475 33 | 1-1/16x1-1/4 | 358 | 14.0 | 13.9 | 15.5 | 42.0 | 49.0 | 1.3 | 1 | \$32.98 | |
| 475 34 | 1-1/8x1-5/16 | 360 | 14.1 | 14.6 | 15.5 | 45.5 | 50.0 | 1.2 | 1 | \$34.98 | |
| 475 35 | 1-3/16x1-5/16 | 360 | 14.1 | 14.6 | 15.5 | 45.5 | 50.0 | 1.3 | 1 | \$36.98 | |
| 475 36 | 1-1/4x1-3/8 | 412 | 16.2 | 17.0 | 18.2 | 48.2 | 53.5 | 1.8 | 1 | \$54.98 | |
| 475 37 | 1-5/16x1-1/2 | 412 | 16.2 | 17.0 | 18.2 | 48.2 | 53.5 | 1.8 | 1 | \$54.98 | |
| 475 38 | 1-7/16x1-5/8 | 440 | 17.3 | 18.0 | 19.5 | 53.5 | 60.5 | 2.3 | 1 | \$69.98 | |
| 475 39 | 1-11/16x1-7/8 | 476 | 18.7 | 19.7 | 21.4 | 63.0 | 70.0 | 2.8 | 1 | \$89.98 | |
| 475 40 | 1-13/16x2 | 500 | 19.6 | 21.4 | 22.4 | 67.0 | 73.0 | 3.4 | 1 | \$119.98 | |

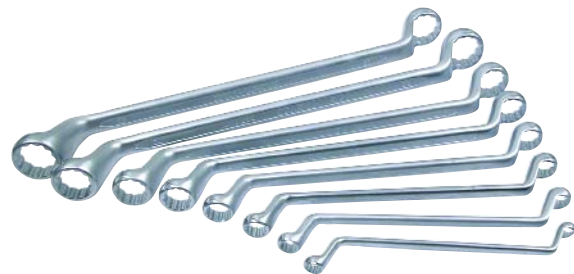
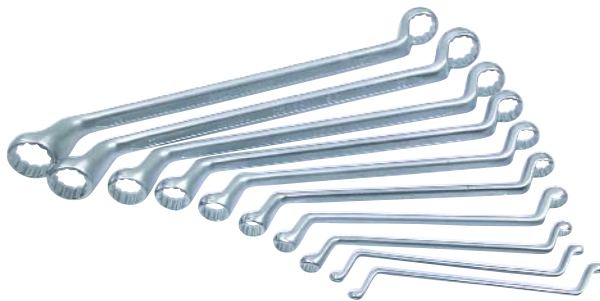

475 90 Set 10 Piece Metric Box Wrenches

| Item No. | mm x mm | OAL mm | Item No. | mm x mm | OAL mm |
|-----------|--------------------|--------|----------|-------------|--------|
| 475 90 | 475 01 5.5 x 7.0 | 165 | 475 06 | 14.0 x 15.0 | 238 |
| ↺ | 475 02 6.0 x 7.0 | 165 | 475 07 | 16.0 x 17.0 | 262 |
| lbs. 3.95 | 475 03 8.0 x 9.0 | 180 | 475 08 | 18.0 x 19.0 | 290 |
| Each | 475 04 10.0 x 11.0 | 195 | 475 09 | 20.0 x 22.0 | 320 |
| \$133.98 | 475 05 12.0 x 13.0 | 216 | 475 10 | 21.0 x 23.0 | 326 |

475 91 Set 8 Piece Inch Box Wrenches

| Item No. | mm x mm | OAL mm | Item No. | mm x mm | OAL mm |
|-----------|-------------------|--------|----------|-------------|--------|
| 475 91 | 475 18 1/4 x 5/16 | 170 | 475 25 | 5/8 x 3/4 | 290 |
| ↺ | 475 20 3/8 x 7/16 | 195 | 475 26 | 11/16 x 3/4 | 290 |
| lbs. 2.55 | 475 21 7/16 x 1/2 | 216 | 475 29 | 13/16 x 7/8 | 320 |
| Each | 475 22 1/2 x 9/16 | 239 | | | |
| \$120.98 | 475 23 9/16 x 5/8 | 239 | | | |

















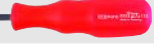









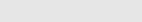



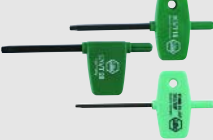







Made in Germany

www.wihatools.com

Click on page number to view product

Wiha Screwdrivers Index

| | Description | Page | |
|---|--|--|----|
|  | Orbit Phillips Drivers | 63 | |
|  | SoftFinish Slotted/Phillips Drivers | 64-66 | |
| | SoftFinish Torx/TR Torx Drivers | 15,176 | |
| | SoftFinish TorxPlus Drivers | 24 | |
| | SoftFinish Pozidriv Drivers | 67 | |
| | SoftFinish Square Drivers | 67 | |
| | SoftFinish Nut Drivers | 49-51 | |
| | SoftFinish Bit Holders | 67,154 | |
| |  | ESD Safe SoftFinish Drivers Slotted/Phillips/Torx | 68 |
| |  | Universal Razor Edge Scraper | 67 |
|  | Microfinish Slotted Drivers | 69-70 | |
| | MicroFinish Phillips Drivers | 69-70 | |
| | MicroFinish Torx Drivers | 16 | |
| | MicroFinish Bit Holders | 69,154 | |
|  | ACO Slotted/Phillips Drivers | 71 | |
|  | 3K Series Slotted/Phillips | 72-73 | |
| | 3K Series Torx Drivers | 18 | |
| | 3K Series Hex Drivers | 41 | |
| | 3K Series Bit Holders | 73,154 | |
|  | Protorn Torx Drivers | 17 | |
|  | Square Handle Slotted Drivers | 74 | |
|  | Square Handle Phillips Drivers | 74 | |
|  | Stubby Screwdrivers | 66 | |
|  | Dynamic Slotted/Phillips Drivers | 75 | |
|  | Magnetizer/Demagnetizer | 75 | |
|  | SYSTEM 6 Handles/Blades | 76-78 | |
|  | SYSTEM 6 Sets | 77-79 | |
|  | Topra Ratchet Handle | 80,147 | |
|  | Round Awls | 80 | |
|  | Square Reaming Awl | 80 | |
|  | Offset Slotted Screwdrivers | 81 | |
|  | Offset Phillips Screwdrivers | 81 | |

| | | | |
|--|---|--------------------------|-----|
|  | Insulated Slotted Drivers | 85 | |
| | Insulated Phillips Drivers | 82-83 | |
| | Insulated Torx Drivers | 85 | |
|  | Insulated Nut Drivers | 53,84 | |
| | Ins Retaining Ring Bit Holder | 85,154 | |
| | Wing Handle Torx Driver | 22,177 | |
|  | Flag Handle Torx Driver | 22 | |
|  | Wing Handle TorxPlus Driver | 25 | |
|  | Torx/Hex/Nut Driver T-handles | 21,38,52 | |
|  | ComfortGrip T-handles L-keys | 20 | |
|  | Multi-Bit Screwdrivers | 149 | |
|  | Bit Holders | 154 | |
|  | ESD Safe Prec Slotted Drivers | 111 | |
| | ESD Safe Prec Phillips Drivers | 111 | |
| | ESD Safe Torx Drivers | 111 | |
| | ESD Safe Prec Hex Drivers | 112 | |
| | ESD Safe Prec Nut Drivers | 112 | |
|  | Precision Slotted Drivers | 113-114 | |
| | Precision Phillips Drivers | 113-114 | |
| | Precision Pozidriv Drivers | 115 | |
| | Precision Hex Drivers | 114 | |
| | Precision Ball End Drivers | 115 | |
| | Precision Nut Drivers | 116 | |
| | Precision Torx Drivers | 117 | |
| | Precision Chip Lifters | 117 | |
| |  | Protorn Prec Slotted Set | 118 |
| |  | Protorn Prec Combo Set | 118 |
|  | Protorn Ball End Hex Set | 119 | |
|  | Protorn Prec Hex Set | 119 | |
|  | Protorn Prec Torx Set | 120 | |
|  | Protorn Chip Lifter | 119 | |
|  | SYSTEM 4 Handles/Blades | 122-123 | |
|  | SYSTEM 4 Sets | 124-126 | |
|  | MicroBits Handles/Blades/Sets | 127-129 | |



Made in Germany

Toll Free: (800) 494-6104

Click image to view web page

Wiha SoftFinish® Orbit Pivoting Phillips Drivers

Works On All Standard Phillips Head Screws

NEW
From Wiha

Reach & turn Phillips screws at up to 20° angle with full 360° rotation

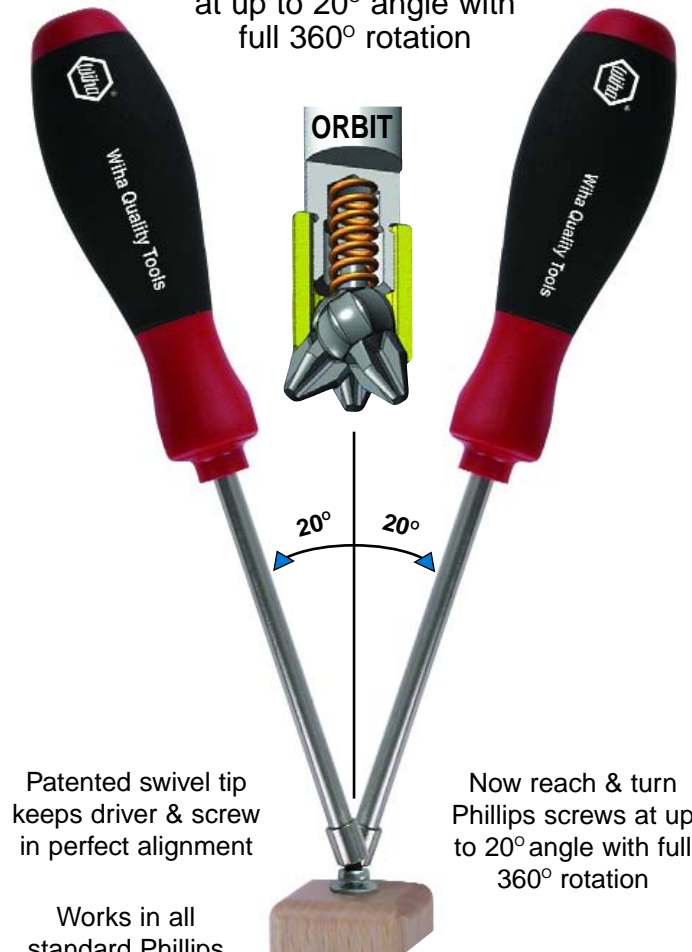
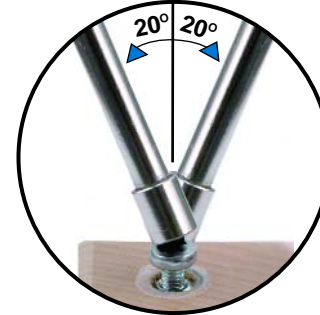

Patented swivel tip keeps driver & screw in perfect alignment

Works in all standard Phillips head screws

Now reach & turn Phillips screws at up to 20° angle with full 360° rotation

2 Piece Orbit Driver Set

- Includes #1 & #2 Phillips drivers
- Now reach and turn Phillips screws at up to 20° angle with full 360° rotation
- Easily access those hard to reach screws
- Patented swivel tip keeps driver & screw in perfect alignment, maintains full engagement
- Reduces cam out damage, screws & tools last longer
- Works on all standard Phillips Screws
- Ergonomic function allows natural wrist rotation
- Easily works around obstructions

**Saves Time!
Improves Productivity!
Makes The Job Easy!**

Wiha Patented Design

US Patent 6,575,062 B2



311 Wiha Orbit Pivot Drivers, With Wiha-SoftFinish® Handle

Hex blade high alloy chrome-vanadium-molybdenum steel, hardened, chrome-plated, Wiha-Chromtop finish on tips. Hex bolster for additional torque. Wiha-SoftFinish® handle, multi-component.

| Item No. | Size | mm | Inch | mm | Inch | lbs. | pkg. | Each |
|----------|------|-----|------|-----|------|------|------|---------|
| 311 68 | 1 | 80 | 3.0 | 191 | 7.5 | 1.64 | 10 | \$9.98 |
| 311 69 | 2 | 100 | 4.0 | 218 | 8.6 | 2.27 | 10 | \$10.98 |

311 99 Set 2 Pcs. Phillips Orbit Pivot Drivers

Hex blade, high alloy chrome-vanadium-molybdenum steel, hardened, chrome-plated. Hex bolster for additional torque. Wiha-Chromtop finish on tips. Wiha-SoftFinish® handle, multi-component.

| Item No. | Size | mm | lbs. | Each | |
|----------|-------|----|------|------|---------|
| 311 99 | 31168 | 1 | 80 | .45 | \$19.98 |
| | 31169 | 2 | 100 | | |



Made in Germany

www.wihatools.com

Click image to view web page

Wiha SoftFinish® Handle - Ergonomic Cushion Grip

The Wiha SoftFinish® Handle: Featuring advanced technology dual material molding. A remarkable improvement in handle design, comfort and performance. The SoftFinish® ergonomic shape allows maximum torque and user comfort.

Wiha exclusive "SoftFinish® Zone" features solid molded core with soft outer cushion grip. Requires less force, yet achieves 40% more torque than conventional handles.

All blades are made of Wiha's exclusive formula chrome-vanadium-molybdenum tool steel, super hardened & chrome-plated for unmatched durability.

Wiha tips are precision machined to exact tolerances for a perfect fit every time.

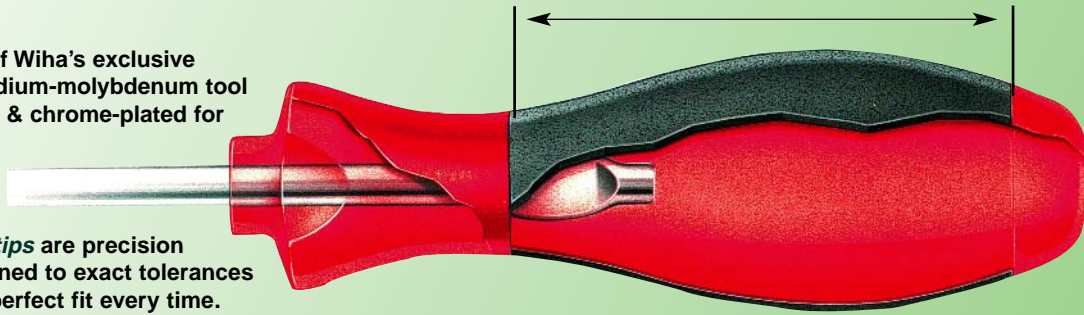

Handle is molded directly onto the blade for a permanent bond. Large optimized handle diameter allows higher torque with less user hand fatigue.

Wiha SoftFinish® Extra Heavy Duty



530 Slotted Screwdriver, With Wiha-SoftFinish® Handle and Solid Metal Cap. Hex blade extending through handle manufactured from high alloy chrome-vanadium-molybdenum steel, hardened, chrome-plated, Wiha-Chromtop finish on tips. Wiha-SoftFinish® handle, multi-component. Hex bolster for additional torque.

| Item No. | mm | Inch | mm | Inch | mm | Inch | mm | Inch | lbs. | pkg. | Each |
|----------|------|------|-----|------|-----|------|-----|------|------|------|---------|
| 530 10* | 3.5 | .139 | 75 | 3.0 | 0.6 | .024 | 186 | 7.3 | .16 | 10 | \$8.60 |
| 530 15* | 4.5 | .177 | 90 | 3.5 | 0.8 | .031 | 201 | 7.9 | .17 | 10 | \$9.10 |
| 530 20 | 5.5 | .196 | 100 | 4.0 | 1.0 | .039 | 213 | 8.4 | .23 | 10 | \$11.10 |
| 530 25 | 6.5 | .255 | 125 | 5.0 | 1.2 | .047 | 238 | 9.4 | .33 | 10 | \$12.10 |
| 530 27 | 8.0 | .315 | 150 | 6.0 | 1.2 | .047 | 268 | 10.6 | .56 | 10 | \$16.80 |
| 530 35 | 10.0 | .393 | 175 | 7.0 | 1.6 | .063 | 293 | 11.6 | .58 | 10 | \$17.20 |
| 530 40 | 12.0 | .472 | 200 | 8.0 | 2.0 | .079 | 318 | 12.5 | .76 | 10 | \$18.20 |

*No Hex Bolster



531 Phillips Screwdriver, With Wiha-SoftFinish® Handle and Solid Metal Cap. Hex blade extending through handle manufactured from high alloy chrome-vanadium-molybdenum steel, hardened, chrome-plated, Wiha-Chromtop finish on tips. Wiha-SoftFinish® handle, multi-component. Hex bolster for additional torque.

| Item No. | Size | mm | Inch | mm | Inch | mm | Inch | lbs. | pkg. | Each |
|----------|------|-----|------|-----|-------|-----|------|------|------|---------|
| 531 10 | 1 | 80 | 3.0 | 5.0 | 13/64 | 186 | 7.3 | .20 | 10 | \$9.10 |
| 531 15 | 2 | 100 | 4.0 | 6.0 | 1/4 | 213 | 8.4 | .32 | 10 | \$11.10 |
| 531 20 | 3 | 150 | 6.0 | 8.0 | 5/16 | 268 | 10.6 | .56 | 10 | \$15.10 |



530 90 Set 5 Pcs. Slotted & Phillips - Extra Heavy Duty

| Item No. | mm | mm | Size | mm | lbs. | | |
|----------|--------|-----|------|--------|------|-----|---------|
| 530 90 | 530 20 | 5.5 | 100 | 531 10 | 1 | 80 | 1.79 |
| | 530 25 | 6.5 | 125 | 531 15 | 2 | 100 | Each |
| | 530 27 | 8.0 | 150 | | | | \$59.68 |



530 97 Set 7 Pcs. Slotted & Phillips - Extra Heavy Duty

| Item No. | mm | mm | Size | mm | lbs. | | |
|----------|--------|------|------|--------|------|-----|---------|
| 530 97 | 530 20 | 5.5 | 100 | 531 10 | 1 | 80 | 3.15 |
| | 530 25 | 6.5 | 125 | 531 15 | 2 | 100 | |
| | 530 27 | 8.0 | 150 | 531 20 | 3 | 150 | Each |
| | 530 35 | 10.0 | 175 | | | | \$91.68 |



Made in Germany

Toll Free: (800) 494-6104

Click image to view web page

Wiha SoftFinish® Heavy Duty Screwdriver



308 Slotted Screwdriver, With Wiha-SoftFinish® Handle

Hex blade high alloy chrome-vanadium-molybdenum steel, hardened, chrome-plated, Wiha-Chromtop finish on tips. Hex bolster for additional torque. Wiha-SoftFinish® handle, multi-component.

| Item | ↓ | ↑ | ← | → | ⊖ | ⊕ | ↺ | ↻ | ↻ | ↻ | ↻ | ↻ | ↻ | ↻ | ↻ | ↻ | ↻ | ↻ | ↻ | ↻ |
|--------|------|------|-----|------|-----|------|-----|------|------|------|---------|---|---|---|---|---|---|---|---|---|
| No. | mm | Inch | mm | Inch | mm | Inch | mm | Inch | lbs. | pkg. | Each | | | | | | | | | |
| 308 15 | 5.5 | .216 | 100 | 4.0 | 1.0 | .039 | 213 | 8.4 | .19 | 10 | \$8.60 | | | | | | | | | |
| 308 17 | 6.5 | .255 | 125 | 5.0 | 1.2 | .047 | 238 | 9.4 | .23 | 10 | \$9.30 | | | | | | | | | |
| 308 20 | 7.0 | .275 | 125 | 5.0 | 1.1 | .043 | 238 | 9.4 | .23 | 10 | \$9.30 | | | | | | | | | |
| 308 25 | 8.0 | .315 | 150 | 6.0 | 1.2 | .047 | 271 | 10.7 | .37 | 10 | \$10.20 | | | | | | | | | |
| 308 30 | 10.0 | .393 | 175 | 7.0 | 1.6 | .063 | 296 | 11.7 | .40 | 10 | \$14.60 | | | | | | | | | |
| 308 35 | 12.0 | .472 | 200 | 8.0 | 2.0 | .079 | 321 | 12.6 | .58 | 10 | \$18.10 | | | | | | | | | |



312 Phillips Screwdriver, With Wiha-SoftFinish® Handle

Hex blade high alloy chrome-vanadium-molybdenum steel, hardened, chrome-plated, Wiha-Chromtop finish on tips. Hex bolster for additional torque. Wiha-SoftFinish® handle, multi-component.

| Item | ⊕ | ← | → | ⊖ | ⊕ | ← | → | ↺ | ↻ | ↻ | ↻ | ↻ | ↻ | ↻ | ↻ | ↻ | ↻ | ↻ | ↻ | ↻ |
|--------|------|-----|------|-----|------|-----|------|------|------|---------|---|---|---|---|---|---|---|---|---|---|
| No. | Size | mm | Inch | mm | Inch | mm | Inch | lbs. | pkg. | Each | | | | | | | | | | |
| 312 01 | 1 | 80 | 3.0 | 5.0 | 3/16 | 186 | 7.3 | .13 | 10 | \$6.70 | | | | | | | | | | |
| 312 02 | 2 | 100 | 4.0 | 6.0 | 7/32 | 213 | 8.4 | .21 | 10 | \$9.10 | | | | | | | | | | |
| 312 03 | 3 | 150 | 6.0 | 8.0 | 5/16 | 271 | 10.7 | .37 | 10 | \$12.80 | | | | | | | | | | |



308 92 Set 5 Pcs. Slotted & Phillips

Hex blade, high alloy chrome-vanadium-molybdenum steel, hardened, chrome-plated. Hex bolster for additional torque. Wiha-Chromtop finish on tips. Wiha-SoftFinish® handle, multi-component.

| Item | ↓ | ↑ | ← | → | ⊖ | ⊕ | ↺ | ↻ | ↻ | ↻ | ↻ | ↻ | ↻ | ↻ | ↻ | ↻ | ↻ | ↻ | ↻ | ↻ | |
|--------|--------|-----|------|--------|----|------|---------|---|---|---|---|---|---|---|---|---|---|---|---|---|--|
| No. | mm | mm | Size | | mm | lbs. | | | | | | | | | | | | | | | |
| 308 92 | 308 15 | 5.5 | 100 | 312 01 | 1 | 80 | 1.40 | | | | | | | | | | | | | | |
| | 308 20 | 7.0 | 125 | 312 02 | 2 | 100 | Each | | | | | | | | | | | | | | |
| | 308 25 | 8.0 | 150 | | | | \$41.80 | | | | | | | | | | | | | | |



308 98 Set 8 Pcs. Slotted & Phillips

| Item | ↓ | ↑ | ← | → | ⊖ | ⊕ | ↺ | ↻ | ↻ | ↻ | ↻ | ↻ | ↻ | ↻ | ↻ | ↻ | ↻ | ↻ | ↻ | ↻ | |
|--------|--------|------|------|--------|----|------|---------|---|---|---|---|---|---|---|---|---|---|---|---|---|--|
| No. | mm | mm | Size | | mm | lbs. | | | | | | | | | | | | | | | |
| 308 98 | 308 15 | 5.5 | 100 | 312 01 | 1 | 80 | 2.52 | | | | | | | | | | | | | | |
| | 308 17 | 6.5 | 125 | 312 02 | 2 | 100 | | | | | | | | | | | | | | | |
| | 308 20 | 7.0 | 125 | 312 03 | 3 | 150 | | | | | | | | | | | | | | | |
| | 308 25 | 8.0 | 150 | | | | Each | | | | | | | | | | | | | | |
| | 308 30 | 10.0 | 175 | | | | \$80.98 | | | | | | | | | | | | | | |



www.wihatools.com

Click image to view web page

Made in Germany

Wiha SoftFinish® Handle - Standard Series



302 Slotted Screwdriver, With Wiha-SoftFinish® Handle

Round blade, high alloy CVM, hardened, chrome-plated, Wiha-Chromtop finish on tips. Wiha-SoftFinish® handle, multi-component.

| Item No. | mm | Inch | mm | Inch | mm | Inch | mm | Inch | lbs. | pkg. | Each |
|----------|------|------|-----|------|-----|------|-----|------|------|------|---------|
| 302 05 | 3.0 | .118 | 100 | 4.0 | 0.5 | .020 | 204 | 8.0 | .06 | 10 | \$4.30 |
| 302 10 | 3.5 | .139 | 100 | 4.0 | 0.6 | .024 | 204 | 8.0 | .07 | 10 | \$4.60 |
| 302 15 | 4.0 | .157 | 100 | 4.0 | 0.8 | .031 | 211 | 8.3 | .11 | 10 | \$4.60 |
| 302 17 | 4.0 | .157 | 150 | 6.0 | 0.8 | .031 | 261 | 10.3 | .12 | 10 | \$4.80 |
| 302 20 | 5.5 | .216 | 125 | 5.0 | 1.0 | .039 | 236 | 9.3 | .15 | 10 | \$5.10 |
| 302 38 | 5.5 | .216 | 300 | 11.8 | 1.0 | .039 | 411 | 16.1 | .24 | 10 | \$7.30 |
| 302 23 | 6.5 | .255 | 100 | 4.0 | 1.0 | .039 | 218 | 8.6 | .20 | 10 | \$6.70 |
| 302 25 | 6.5 | .255 | 150 | 6.0 | 1.2 | .047 | 268 | 10.6 | .22 | 10 | \$6.90 |
| 302 27 | 8.0 | .315 | 150 | 6.0 | 1.2 | .047 | 274 | 10.8 | .29 | 10 | \$9.10 |
| 302 30 | 8.0 | .315 | 175 | 7.0 | 1.2 | .047 | 299 | 11.8 | .30 | 10 | \$9.10 |
| 302 35 | 10.0 | .393 | 200 | 8.0 | 1.6 | .063 | 324 | 12.8 | .36 | 10 | \$10.20 |
| 302 36 | 12.0 | .472 | 250 | 9.8 | 2.0 | .078 | 374 | 14.7 | .52 | 10 | \$14.00 |

302 Stubby Slotted Screwdriver, With Wiha-SoftFinish® Handle

| Item No. | mm | Inch | mm | Inch | mm | Inch | mm | Inch | lbs. | pkg. | Each |
|----------|-----|------|----|------|-----|------|----|------|------|------|--------|
| 302 39 | 4.0 | .157 | 25 | 1.0 | 0.8 | .031 | 75 | 2.95 | .09 | 10 | \$4.80 |
| 302 55 | 5.5 | .216 | 25 | 1.0 | 1.0 | .039 | 75 | 2.95 | .09 | 10 | \$6.00 |
| 302 65 | 6.5 | .255 | 25 | 1.0 | 1.2 | .047 | 75 | 2.95 | .10 | 10 | \$6.10 |



311 Phillips Screwdriver, With Wiha-SoftFinish® Handle

Round blade, high alloy CVM steel, hardened, chrome-plated, Wiha-Chromtop finish on tips. Wiha-SoftFinish® handle, multi-component.

| Item No. | Size | mm | Inch | mm | Inch | mm | Inch | lbs. | pkg. | Each |
|----------|------|-----|------|------|------|-----|------|------|------|---------|
| 311 05 | 0 | 60 | 2.4 | 3.0 | .118 | 164 | 6.5 | .06 | 10 | \$3.60 |
| 311 10 | 1 | 80 | 3.0 | 4.5 | .177 | 191 | 7.5 | .11 | 10 | \$4.90 |
| 311 12 | 1 | 200 | 8.0 | 4.5 | .177 | 311 | 12.3 | .15 | 10 | \$6.60 |
| 311 14 | 1 | 300 | 12.0 | 4.5 | .177 | 411 | 16.2 | .18 | 10 | \$9.60 |
| 311 15 | 2 | 100 | 4.0 | 6.0 | .236 | 218 | 8.6 | .20 | 10 | \$6.60 |
| 311 17 | 2 | 200 | 8.0 | 6.0 | .236 | 318 | 12.5 | .25 | 10 | \$7.10 |
| 311 18 | 2 | 300 | 12.0 | 6.0 | .236 | 418 | 16.5 | .30 | 10 | \$8.00 |
| 311 20 | 3 | 150 | 6.0 | 8.0 | .315 | 274 | 10.8 | .33 | 10 | \$9.10 |
| 311 25 | 4 | 200 | 8.0 | 10.0 | .393 | 323 | 12.7 | .51 | 10 | \$14.30 |

311 Stubby Phillips Screwdriver, With Wiha-SoftFinish® Handle

| Item No. | Size | mm | Inch | mm | Inch | mm | Inch | lbs. | pkg. | Each |
|----------|------|----|------|-----|------|----|------|------|------|--------|
| 311 35 | 1 | 25 | 1.0 | 4.5 | .177 | 75 | 3.0 | .09 | 10 | \$4.30 |
| 311 40 | 2 | 25 | 1.0 | 6.0 | .236 | 75 | 3.0 | .10 | 10 | \$4.80 |



302 95 Set 5 Pcs. Slotted & Phillips

| Item No. | mm | Inch | mm | Inch | mm | Inch | lbs. | Each |
|----------|--------|------|-----|--------|----|------|---------|------|
| 302 95 | 302 05 | 3.0 | 100 | 311 10 | 1 | 80 | 1.02 | |
| | 302 15 | 4.0 | 100 | 311 15 | 2 | 100 | Each | |
| | 302 25 | 6.5 | 150 | | | | \$26.98 | |



302 94 Set 6 Pcs. Slotted & Phillips

Round blade, high alloy CVM steel, hardened, chrome-plated. Wiha-Chromtop finish on tips. Wiha-SoftFinish® handle, multi-component.

| Item No. | mm | Inch | mm | Inch | mm | Inch | lbs. | Each |
|----------|--------|------|-----|--------|----|------|---------|------|
| 302 94 | 302 15 | 4.0 | 100 | 311 10 | 1 | 80 | 1.29 | |
| | 302 25 | 6.5 | 150 | 311 15 | 2 | 100 | | |
| | 302 27 | 8.0 | 150 | | | | Each | |
| | 302 39 | 4.0 | 25 | | | | \$37.48 | |

302 98 Set 8 Pcs. Slotted & Phillips

Round blade, high alloy CVM steel, hardened, chrome-plated. Wiha-Chromtop finish on tips. Wiha-SoftFinish® handle, multi-component.

| Item No. | mm | Inch | mm | Inch | mm | Inch | lbs. | Each |
|----------|--------|------|-----|--------|----|------|---------|------|
| 302 98 | 302 05 | 3.0 | 100 | 311 10 | 1 | 80 | 1.87 | |
| | 302 15 | 4.0 | 100 | 311 15 | 2 | 100 | | |
| | 302 20 | 5.5 | 125 | 311 20 | 3 | 150 | | |
| | 302 25 | 6.5 | 150 | | | | Each | |
| | 302 30 | 8.0 | 175 | | | | \$49.48 | |



302 97 Set 12 Pcs. Slotted & Phillips

Round blade, high alloy CVM steel, hardened, chrome-plated. Wiha-Chromtop finish on tips. Wiha-SoftFinish® handle, multi-component.

| Item No. | mm | Inch | mm | Inch | mm | Inch | lbs. | Each |
|----------|---------|------|-----|---------|----|------|---------|------|
| 302 97 | 302 05 | 3.0 | 100 | 311 05 | 0 | 60 | 2.48 | |
| | 302 15 | 4.0 | 100 | 311 10 | 1 | 80 | | |
| | 302 20 | 5.5 | 125 | *311 40 | 2 | 25 | | |
| | 302 25 | 6.5 | 150 | 311 15 | 2 | 100 | | |
| | *302 65 | 6.5 | 25 | 311 20 | 3 | 150 | | |
| | 302 30 | 8.0 | 175 | | | | Each | |
| | 302 35 | 10 | 200 | | | | \$73.98 | |

302 99 Set 20 Pcs. Slotted, Phillips, TORX®, Square & Pozidriv®

| Item No. | Slotted | mm | Inch | Phillips | Size | mm | TORX® | mm | Inch |
|----------|---------|-----|------|----------|------|-----|--------|-----|---------|
| 302 99 | 302 05 | 3.0 | 100 | 311 05 | 0 | 60 | 362 66 | T6 | 60 |
| | 302 15 | 4.0 | 100 | 311 10 | 1 | 80 | 362 70 | T8 | 60 |
| | 302 20 | 5.5 | 125 | 311 15 | 2 | 100 | 362 74 | T10 | 80 |
| | 302 25 | 6.5 | 150 | | | | 362 76 | T15 | 80 |
| | 302 30 | 8.0 | 175 | | | | 362 78 | T20 | 100 |
| | | | | | | | 362 80 | T25 | 100 |
| | | | | | | | 362 84 | T30 | 115 |
| | | | | | | | | | Each |
| | | | | | | | | | \$99.98 |

*Stubby screwdriver with Wiha SoftFinish handle



Made in Germany

Toll Free: (800) 494-6104

Click image to view web page



384 1/4" Bit Holding Screwdriver, With Wiha-SoftFinish® Handle
Magnetic, holds bit and screw. Retainer out of stainless steel. Shaft CVM steel, nickel-plated. Cushion grip handles.

| Item | ○ | — | — | — | — | — | — | — | — |
|--------|------|-----|------|-----|------|------|------|---------|---|
| No. | Size | mm | Inch | mm | Inch | lbs. | pkg. | Each | |
| 384 50 | 1/4" | 125 | 5.0 | 240 | 9.5 | .23 | 10 | \$10.68 | |
| 384 60 | 1/4" | 300 | 11.8 | 418 | 16.4 | .33 | 10 | \$17.98 | |

See additional bit holders on page 154



384 90 Wiha-SoftFinish® Handle Bit Holder & Bit-Selector Set
Magnetic, holds bit and screw. Retainer out of stainless steel. Shaft chrome-vanadium-molybdenum steel, nickel-plated.

Set includes 1/4" magnetic bit holder and 6 of the following bits:

| | | | |
|---|--------------------------------|-----|---------|
| ⊖ | Slotted sizes: 5.5, 6.5mm | ↔ | Each |
| ⊕ | Phillips sizes: #0, #1, #2, #3 | .53 | \$19.98 |



358 Square Screwdriver, With Wiha-SoftFinish® Handle
Round blade high alloy chrome-vanadium-molybdenum steel, hardened, chrome-plated, Wiha-Chromtop finish on tips. Wiha-SoftFinish® handle, multi-component, cushion grips.

| Item | ○ | — | — | ⊖ | ⊕ | — | — | — | — | |
|--------|------|-----|------|-----|------|-----|------|------|------|--------|
| No. | Size | mm | Inch | mm | Inch | mm | Inch | lbs. | pkg. | Each |
| 358 01 | 1 | 100 | 4.0 | 4.5 | 5/32 | 210 | 8.2 | .12 | 10 | \$4.50 |
| 358 02 | 2 | 150 | 6.0 | 5.0 | 1/4 | 268 | 10.5 | .19 | 10 | \$4.90 |
| 358 03 | 3 | 150 | 6.0 | 6.0 | 1/4 | 268 | 10.5 | .22 | 10 | \$5.30 |



313 Pozidriv® Screwdriver, With Wiha-SoftFinish® Handle
Round blade high alloy chrome-vanadium-molybdenum steel, hardened, chrome-plated, Wiha-Chromtop finish on tips. Wiha-SoftFinish® handle, multi-component, cushion grips.

| Item | ⊕ | — | — | ⊖ | ⊕ | — | — | — | — | |
|--------|------|-----|------|-----|------|-----|------|------|------|---------|
| No. | Size | mm | Inch | mm | Inch | mm | Inch | lbs. | pkg. | Each |
| 313 05 | 0 | 60 | 2.4 | 3.0 | .118 | 164 | 6.5 | .06 | 10 | \$4.70 |
| 313 10 | 1 | 80 | 3.0 | 4.5 | .177 | 191 | 7.5 | .11 | 10 | \$5.60 |
| 313 12 | 1 | 200 | 7.8 | 4.5 | .177 | 311 | 12.3 | .15 | 10 | \$7.30 |
| 313 15 | 2 | 100 | 4.0 | 6.0 | .236 | 218 | 8.6 | .20 | 10 | \$7.30 |
| 313 20 | 3 | 150 | 6.0 | 8.0 | .315 | 274 | 10.8 | .33 | 10 | \$10.90 |

Wiha Universal Razor Edged Scraper



SoftFinish "Cushion" Grip

430 90 Universal Razor Edged Scraper, With Wiha-SoftFinish® Handle Removes sealing material, glue residue, layers of film and labels. Includes item #43092 - 10 replacement blades.

| Item | — | — | ↔ | ↔ | |
|--------|-----|------|------|------|---------|
| No. | mm | Inch | lbs. | pkg. | Each |
| 430 90 | 170 | 6.7 | .22 | 1 | \$13.98 |

430 40 Universal Razor Edged Scraper, With Wiha-SoftFinish® Handle Removes sealing material, glue residue, layers of film, and labels. Handle only.

| Item | — | — | ↔ | ↔ | |
|--------|-----|------|------|------|---------|
| No. | mm | Inch | lbs. | pkg. | Each |
| 430 40 | 140 | 5.5 | .15 | 10 | \$10.98 |

430 92 Replacement Blades for Universal Razor Edged Scraper Package of 10 blades. Standard.

| Item No. | ↔ | ↔ | lbs. | Each |
|----------|-----|--------|------|------|
| 430 92 | .07 | \$3.98 | | |

430 93 Replacement Blades for Universal Razor Edged Scraper Package of 10 blades. Standard.

| Item No. | ↔ | ↔ | lbs. | Each |
|----------|-----|--------|------|------|
| 430 93 | .07 | \$3.98 | | |

430 94 Replacement Blades for Universal Razor Edged Scraper Package of 10 blades.

| Item No. | ↔ | ↔ | lbs. | Each |
|----------|-----|--------|------|------|
| 430 94 | .07 | \$3.98 | | |

430 95 Replacement Blades for Universal Razor Edged Scraper Package of 10 blades.

| Item No. | ↔ | ↔ | lbs. | Each |
|----------|-----|--------|------|------|
| 430 95 | .07 | \$5.98 | | |

430 96 Replacement Blades for Universal Razor Edged Scraper Package of 10 blades.

| Item No. | ↔ | ↔ | lbs. | Each |
|----------|-----|--------|------|------|
| 430 96 | .07 | \$3.98 | | |

430 97 Replacement Blades for Universal Razor Edged Scraper Combo Pack. Package of 10 blades - 2 of each blade.

| Item No. | ↔ | ↔ | lbs. | Each |
|----------|-----|--------|------|------|
| 430 97 | .07 | \$4.98 | | |



900 00 Plastic Screwdriver Tool Rack Rack holds all Wiha screwdrivers, with holes for hanging. Made from high quality plastic.

| Item | ↔ | ↔ | lbs. | pkg. | Each |
|--------|--------------------------------------|---|------|------|--------|
| 900 00 | Rack for Wiha screwdrivers 5.75 x 2" | | .10 | 1 | \$3.00 |



Made in Germany

www.wihatools.com

Click image to view web page

Wiha ESD Safe SoftFinish Cushion Grip Screwdrivers

For working on electrostatically sensitive components

Dissipative material
Offers protection against electrostatic discharge

NEW
from Wiha

SoftFinish cushion grip handle

Chrome-vanadium-molybdenum steel hardened, chrome-plated

DIN EN 61340-5-1/ 61340-5-2



302 92 Set 6 Pcs. ESD Safe Slotted & Phillips
DIN EN 61340-5-1/ 61340-5-2 Round blade, high alloy CVM steel, hardened, chrome-plated. Dissipative SoftFinish® cushion grip handle, multi-component, ESD Safe (10⁶-10⁹ Ohm).

| Item No. | Slotted | Phillips | Size | mm | lbs. |
|----------|---------|----------|------|--------------|---------|
| 302 42 | 3.0 | .118 | 100 | 311 50 0 60 | .96 |
| 302 44 | 4.0 | .157 | 100 | 311 51 1 80 | Each |
| 302 46 | 5.5 | .216 | 125 | 311 52 2 100 | \$36.98 |



302 ESD Safe Slotted Screwdrivers, With Wiha-SoftFinish® Handle
DIN EN 61340-5-1/ 61340-5-2 Round blade, high alloy CVM steel, hardened, chrome-plated. Offers protection against electrostatic discharge. Dissipative SoftFinish® cushion grip handle, multi-component, ESD Safe (10⁶-10⁹ Ohm).

| Item No. | Slotted | Phillips | Size | mm | Inch | mm | Inch | lbs. | pkg. | Each |
|----------|---------|----------|------|-----|------|------|------|------|------|-----------|
| 302 40 | 2.5 | .098 | 75 | 3.0 | 0.4 | .016 | 175 | 7.0 | .06 | 10 \$4.98 |
| 302 42 | 3.0 | .118 | 100 | 4.0 | 0.5 | .020 | 204 | 8.0 | .06 | 10 \$5.48 |
| 302 44 | 4.0 | .157 | 100 | 4.0 | 0.8 | .031 | 211 | 8.3 | .11 | 10 \$5.98 |
| 302 46 | 5.5 | .216 | 125 | 5.0 | 1.0 | .039 | 236 | 9.3 | .15 | 10 \$6.98 |
| 302 48 | 6.5 | .255 | 150 | 6.0 | 1.2 | .047 | 268 | 10.6 | .22 | 10 \$7.98 |



362 ESD Safe TORX® Screwdriver, With Wiha-SoftFinish® Handle
DIN EN 61340-5-1/ 61340-5-2 Round blade, high alloy CVM steel, hardened, chrome-plated. Offers protection against electrostatic discharge. Dissipative SoftFinish® cushion grip handle, multi-component, ESD Safe (10⁶-10⁹ Ohm).

| Item No. | TORX | Size | mm | Inch | mm | Inch | lbs. | pkg. | Each |
|----------|------|------|-----|------|------|------|------|------|-----------|
| 362 04 | T4 | 60 | 2.4 | 3.5 | .139 | 164 | 6.5 | .06 | 10 \$5.98 |
| 362 06 | T6 | 60 | 2.4 | 3.5 | .139 | 164 | 6.5 | .06 | 10 \$5.98 |
| 362 08 | T8 | 60 | 2.4 | 3.5 | .139 | 164 | 6.5 | .06 | 10 \$5.98 |
| 362 09 | T9 | 60 | 2.4 | 4.0 | .157 | 171 | 6.7 | .10 | 10 \$5.98 |
| 362 18 | T10 | 80 | 3.0 | 4.0 | .157 | 191 | 7.5 | .11 | 10 \$5.98 |
| 362 19 | T15 | 80 | 3.0 | 4.0 | .157 | 191 | 7.5 | .11 | 10 \$5.98 |
| 362 24 | T20 | 100 | 4.0 | 4.0 | .157 | 211 | 8.3 | .11 | 10 \$5.98 |



311 ESD Safe Phillips Screwdriver, With Wiha-SoftFinish® Handle
DIN EN 61340-5-1/ 61340-5-2 Round blade, high alloy CVM steel, hardened, chrome-plated. Offers protection against electrostatic discharge. Dissipative SoftFinish® cushion grip handle, multi-component, ESD Safe (10⁶-10⁹ Ohm).

| Item No. | Phillips | Size | mm | Inch | mm | Inch | lbs. | pkg. | Each |
|----------|----------|------|-----|------|------|------|------|------|-----------|
| 311 50 | 0 | 60 | 2.4 | 3.0 | 1/8 | 164 | 6.5 | .06 | 10 \$5.68 |
| 311 51 | 1 | 80 | 3.0 | 4.5 | 3/16 | 191 | 7.5 | .11 | 10 \$5.98 |
| 311 52 | 2 | 100 | 4.0 | 6.0 | 1/4 | 218 | 8.6 | .20 | 10 \$6.98 |



362 89 Set 6 Pcs. ESD Safe TORX® Screwdrivers
Round blade high alloy chrome-vanadium-molybdenum steel, hardened, Hard chrome finish with Wiha-Chromtop satin grip tips. Molded on SoftFinish® cushion grip handle, multi-component.

| Item No. | TORX | Size | mm | TORX | Size | mm | lbs. |
|----------|--------|------|----|--------|------|-----|---------|
| 362 89 | 362 06 | T6 | 60 | 362 18 | T10 | 80 | .81 |
| | 362 08 | T8 | 60 | 362 19 | T15 | 80 | Each |
| | 362 09 | T9 | 60 | 362 24 | T20 | 100 | \$33.98 |



Made in Germany

Toll Free: (800) 494-6104

Click image to view web page

Wiha MicroFinish Handle - Non-Slip Grip

Wiha MicroFinish handle has a patented non-slip surface - it won't peel, crack or deteriorate when exposed to petroleum solvents. Oil and moisture flow away from the handle surface for a powerful, non-slip grip. You get maximum force and comfort with dry, oily or wet hands.

Blade Chrome-vanadium-molybdenum, hardened and tempered tool steel, gives exceptional tool life, wear resistance and high torque performance.

Exact fit precision ground tips.

Blades are hardened & chrome-plated.

MicroFinish Handle with patented non slip surface. Ergonomic handle shape for maximum comfort and exceptional torque transfer.

Safe, high density material, eliminates risk of sharp objects becoming embedded in the handle.

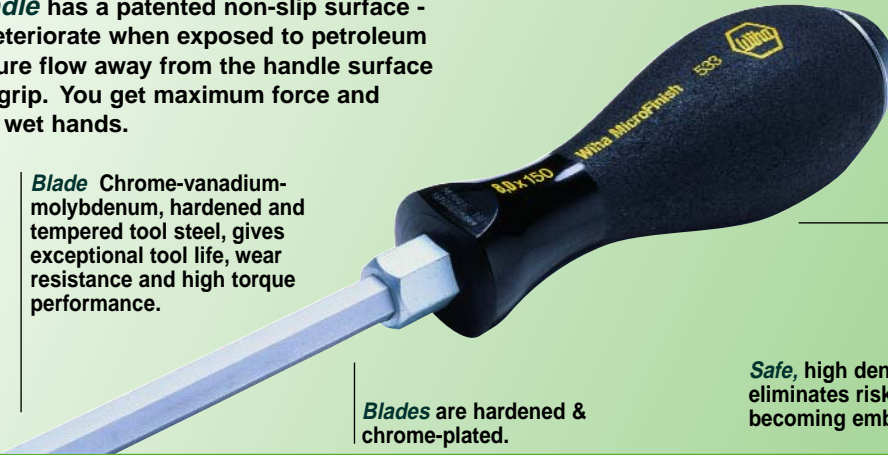

520 Slotted Screwdriver, With Wiha-MicroFinish Handle

Blade high alloy chrome-vanadium-molybdenum steel, hardened, chrome-plated. Wiha-MicroFinish handle, cellulose-acetate, impact resistant, non-slip, oil and grease resistant. Round blades.

| Item No. | mm | Inch | mm | Inch | mm | Inch | mm | Inch | lbs | pkg. | Each |
|----------|------|------|-----|------|-----|------|-----|------|-----|------|---------|
| 520 05 | 4.0 | .157 | 100 | 4.0 | 0.8 | .031 | 211 | 8.3 | .16 | 10 | \$5.70 |
| 520 10 | 4.0 | .157 | 150 | 6.0 | 0.8 | .031 | 261 | 10.3 | .17 | 10 | \$6.50 |
| 520 20 | 5.5 | .216 | 125 | 5.0 | 1.0 | .039 | 236 | 9.3 | .20 | 10 | \$6.40 |
| 520 25 | 5.5 | .216 | 150 | 6.0 | 1.0 | .039 | 261 | 10.3 | .21 | 10 | \$6.90 |
| 520 35 | 6.5 | 6.5 | 150 | 6.0 | 1.2 | .047 | 268 | 10.6 | .28 | 10 | \$8.70 |
| 520 40 | 8.0 | .315 | 150 | 6.0 | 1.2 | .047 | 274 | 10.8 | .37 | 10 | \$11.10 |
| 520 50 | 10.0 | .393 | 200 | 8.0 | 1.6 | .063 | 324 | 12.8 | .50 | 10 | \$12.50 |

521 Phillips Screwdriver, With Wiha-MicroFinish Handle

Blade high alloy chrome-vanadium-molybdenum steel, hardened, chrome-plated. Wiha-MicroFinish handle, cellulose-acetate, impact resistant, non-slip, oil and grease resistant. Round blades.

| Item No. | Size | mm | Inch | mm | Inch | lbs. | pkg. | Each |
|----------|------|-----|------|-----|------|------|------|---------|
| 521 05 | 1 | 80 | 3.1 | 191 | 7.5 | .15 | 10 | \$6.30 |
| 521 10 | 1 | 200 | 8.1 | 311 | 12.2 | .21 | 10 | \$7.40 |
| 521 15 | 2 | 100 | 4.0 | 218 | 8.6 | .26 | 10 | \$8.50 |
| 521 20 | 2 | 200 | 8.0 | 318 | 12.5 | .34 | 10 | \$9.60 |
| 521 25 | 3 | 150 | 6.0 | 274 | 10.8 | .41 | 10 | \$11.70 |



526 1/4" Bit holding Screwdriver, With Wiha-MicroFinish Handle

Magnetic, holds bit and screw. Retainer out of stainless steel. Shaft chrome-vanadium steel, nickel-plated. Wiha-MicroFinish handle, cellulose-acetate, impact resistant, non-slip, oil and grease resistant.

| Item No. | Size | mm | Inch | mm | Inch | lbs. | pkg. | Each |
|----------|------|-----|------|-----|------|------|------|---------|
| 526 50 | 1/4 | 125 | 5.0 | 243 | 9.6 | .24 | 10 | \$13.80 |

See additional bit holders on page 154

520 90 Set 5 Pcs. Slotted & Phillips

Blade chrome-vanadium-molybdenum steel, hardened, chrome-plated. Wiha-MicroFinish handle, cellulose acetate, impact resistant, non-slip, oil and grease resistant.

| Item No. | mm | mm | Size | mm | lbs. | | |
|----------|--------|-----|------|--------|------|-----|---------|
| 520 90 | 520 05 | 4.0 | 100 | 521 05 | 1 | 80 | 1.2 |
| | 520 20 | 5.5 | 125 | 521 15 | 2 | 100 | Each |
| | 520 40 | 8.0 | 150 | | | | \$37.60 |





Made in Germany

www.wihatools.com

Click image to view web page

Wiha MicroFinish Extra Heavy Duty Handle



533 Heavy Duty Slotted Screwdriver, Wiha-MicroFinish Handle & Steel Striking Cap. Blade high alloy chrome-vanadium-molybdenum steel, hardened, chrome-plated. Hex blade extending through handle with striking plate. Hex bolster for additional torque. Wiha-MicroFinish handle, cellulose-acetate, impact resistant, non-slip, oil and grease resistant.

| Item No. | ↓ | ↕ | ↔ | ↔ | ↕ | ↕ | ↔ | ↔ | ↕ | ↕ | ↔ | ↔ | ↕ | ↕ |
|----------|------|------|-----|------|-----|------|-----|------|------|------|---------|---|---|---|
| | mm | Inch | mm | Inch | mm | Inch | mm | Inch | lbs. | pkg. | Each | | | |
| 533 10* | 4.5 | .177 | 90 | 3.6 | 1.0 | .039 | 201 | 7.9 | .20 | 10 | \$8.80 | | | |
| 533 15 | 5.5 | .216 | 100 | 4.0 | 1.0 | .039 | 213 | 8.4 | .33 | 10 | \$10.40 | | | |
| 533 20 | 6.5 | .255 | 125 | 5.0 | 1.2 | .047 | 238 | 9.4 | .38 | 10 | \$11.60 | | | |
| 533 25 | 8.0 | .315 | 150 | 6.0 | 1.2 | .047 | 271 | 10.7 | .61 | 10 | \$16.10 | | | |
| 533 30 | 10.0 | .393 | 175 | 7.0 | 1.6 | .063 | 296 | 11.7 | .65 | 10 | \$16.40 | | | |

*No hex bolster.



534 Heavy Duty Phillips Screwdriver, Wiha-MicroFinish Handle & Steel Striking Cap. Blade high alloy chrome-vanadium-molybdenum steel, hardened, chrome-plated. Hex blade extending through handle with striking plate. Hex bolster for additional torque. Wiha-MicroFinish handle, cellulose-acetate, impact resistant, non-slip, oil and grease resistant.

| Item No. | ⊕ | ↔ | ↔ | ↔ | ↔ | ↕ | ↕ | ↔ | ↔ | ↕ | ↕ | ↔ | ↔ | ↕ |
|----------|------|-----|------|-----|------|------|------|---------|---|---|---|---|---|---|
| | Size | mm | Inch | mm | Inch | lbs. | pkg. | Each | | | | | | |
| 534 05* | 1 | 80 | 3.1 | 186 | 7.3 | .22 | 10 | \$9.00 | | | | | | |
| 534 10 | 2 | 100 | 4.0 | 213 | 8.4 | .37 | 10 | \$10.90 | | | | | | |
| 534 25 | 3 | 150 | 6.0 | 268 | 10.6 | .71 | 10 | \$14.50 | | | | | | |

*No hex bolster.



533 90 Set 5 Pcs. Slotted & Phillips, Heavy Duty Set
Blade chrome-vanadium-molybdenum steel, hardened, chrome-plated. Hex blade extending through handle with steel striking cap. Hex bolster for additional torque. Wiha-MicroFinish handle, cellulose-acetate, impact resistant, non-slip, oil and grease resistant.

| Item No. | ↓ | ↕ | ↔ | ⊕ | ↔ | ↕ | ↕ | ↔ | ↔ | ↕ | ↕ | ↔ | ↔ | ↕ |
|----------|--------|-----|-----|---------|----|------|---------|---|---|---|---|---|---|---|
| | mm | mm | mm | Size | mm | lbs. | | | | | | | | |
| 533 90 | 533 15 | 5.5 | 100 | 534 05* | 1 | 80 | 2.1 | | | | | | | |
| | 533 20 | 6.5 | 125 | 534 10 | 2 | 100 | Each | | | | | | | |
| | 533 25 | 8.0 | 150 | | | | \$58.80 | | | | | | | |

*No hex bolster.



533 98 Set 8 Pcs. Slotted & Phillips, Heavy Duty Set
Blade chrome-vanadium-molybdenum steel, hardened, chrome-plated. Hex blade extending through handle with steel striking cap. Hex bolster for additional torque. Wiha-MicroFinish handle, cellulose-acetate, impact resistant, non-slip, oil and grease resistant.

| Item No. | ↓ | ↕ | ↔ | ⊕ | ↔ | ↕ | ↕ | ↔ | ↔ | ↕ | ↕ | ↔ | ↔ | ↕ |
|----------|---------|------|-----|---------|----|------|---------|---|---|---|---|---|---|---|
| | mm | mm | mm | Size | mm | lbs. | | | | | | | | |
| 533 98 | 533 10* | 4.5 | 90 | 534 05* | 1 | 80 | 3.67 | | | | | | | |
| | 533 15 | 5.5 | 100 | 534 10 | 2 | 100 | | | | | | | | |
| | 533 20 | 6.5 | 125 | 534 25 | 3 | 150 | | | | | | | | |
| | 533 25 | 8.0 | 150 | | | | Each | | | | | | | |
| | 533 30 | 10.0 | 175 | | | | \$98.48 | | | | | | | |

*No hex bolster.

See MicroFinish Torx Drivers On Page 16



Made in Germany

Toll Free: (800) 494-6104

Click image to view web page

Wiha ACO Slotted & Phillips Screwdrivers

ACO

Anti-Cam-Out Ribs

Anti-Cam-Out ribs give maximum grip in the screw head

Dual material handle has molded in soft grip panels & hang hole

Round blade made CVM special tool steel

Precision machined exact fit slotted tips ACO ribs

3K overdrive maximum comfort molded on ergonomic handle

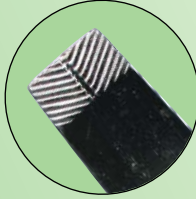

469 ACO Slotted Screwdriver, With Wiha-3K Series Handle

Blade chrome-vanadium-molybdenum steel, hardened, nickel-plated. Wiha-3k Ergo handle, cushion grip.

| Item No. | mm | Inch | mm | Inch | mm | Inch | mm | Inch | lbs. | pkg. | Each |
|----------|-----|------|-----|------|-----|------|-----|------|------|------|--------|
| 469 12 | 4.5 | .177 | 80 | 3.1 | 1.3 | .050 | 186 | 7.3 | .13 | 10 | \$3.98 |
| 469 15 | 4.5 | .177 | 150 | 6.0 | 1.3 | .050 | 256 | 10.0 | .16 | 10 | \$4.98 |
| 469 21 | 6.0 | .236 | 100 | 4.0 | 1.5 | .058 | 218 | 8.5 | .21 | 10 | \$5.58 |
| 469 24 | 6.0 | .236 | 150 | 6.0 | 1.5 | .058 | 269 | 10.5 | .23 | 10 | \$5.98 |
| 469 33 | 8.0 | .315 | 150 | 6.0 | 2.0 | .078 | 269 | 10.5 | .27 | 10 | \$6.98 |



469 91 Set 6 Pcs. Slotted & Phillips 3K ACO Soft Grip Set

Blade chrome-vanadium-molybdenum steel, hardened, nickel-plated. Wiha-3k Ergo handle, cushion grip.

| Item No. | mm | mm | Size | mm | lbs. | | |
|----------|--------|-----|------|--------|------|-----|---------|
| 469 91 | 469 12 | 4.5 | 80 | 468 03 | 1 | 80 | 1.49 |
| | 469 21 | 6.0 | 100 | 468 06 | 1 | 150 | Each |
| | 469 33 | 8.0 | 150 | 468 12 | 2 | 100 | \$32.48 |



468 ACO Phillips Screwdriver, With Wiha-3K Series Handle

Blade chrome-vanadium-molybdenum steel, hardened, nickel-plated. Wiha-3k Ergo handle, cushion grip.

| Item No. | Size | mm | Inch | mm | Inch | lbs. | pkg. | Each |
|----------|------|-----|------|-----|------|------|------|--------|
| 468 03 | 1 | 80 | 3.1 | 186 | 7.3 | .13 | 10 | \$3.98 |
| 468 06 | 1 | 150 | 6.0 | 257 | 10.1 | .15 | 10 | \$4.98 |
| 468 12 | 2 | 100 | 4.0 | 218 | 8.5 | .21 | 10 | \$5.98 |
| 468 15 | 2 | 150 | 6.0 | 234 | 9.2 | .23 | 10 | \$6.98 |

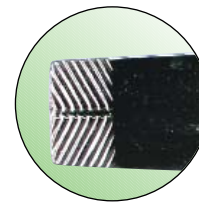

ACO Slotted

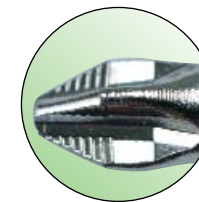

ACO Phillips



Made in Germany

www.wihatools.com

Click image to view web page

Wiha 3K Series Screwdrivers and Sets

3K Ergonomic Series Screwdrivers & Sets



Exact fit precision machined tips

Hole in handle for hanging

Dual material handle has molded soft grip panels

Blades made of chrome-vanadium-molybdenum tool steel, hardened, nickel-plated



460 Slotted Screwdriver, With Wiha-3K Series Handle
Blade chrome-vanadium-molybdenum steel, hardened, nickel-plated. Wiha-3k Ergo handle, cushion grip.

| Item No. | mm | Inch | mm | Inch | mm | Inch | mm | Inch | lbs. | pkg. | Each |
|----------|------|------|-----|------|-----|------|-----|------|------|------|--------|
| 460 60** | 2.5 | .098 | 75 | 3.0 | 0.4 | .016 | 161 | 6.3 | .06 | 10 | \$3.30 |
| 460 70** | 3.0 | .118 | 100 | 4.0 | 0.5 | .020 | 185 | 7.3 | .07 | 10 | \$3.30 |
| 460 72** | 3.5 | .139 | 100 | 4.0 | 0.6 | .024 | 197 | 7.7 | .09 | 10 | \$3.80 |
| 460 74** | 4.0 | .157 | 100 | 4.0 | 0.8 | .031 | 206 | 8.1 | .12 | 10 | \$3.80 |
| 460 75 | 4.5 | .177 | 100 | 4.0 | 1.0 | .039 | 207 | 8.1 | .13 | 10 | \$3.50 |
| 460 76 | 4.5 | .177 | 150 | 6.0 | 1.0 | .039 | 257 | 10.1 | .14 | 10 | \$4.20 |
| 460 77 | 4.5 | .177 | 200 | 8.0 | 1.0 | .039 | 306 | 12.0 | .15 | 10 | \$4.50 |
| 460 78 | 5.5 | .216 | 125 | 5.0 | 1.0 | .039 | 243 | 9.5 | .19 | 10 | \$3.90 |
| 460 80 | 6.0 | .236 | 100 | 4.0 | 0.9 | .035 | 218 | 8.5 | .20 | 10 | \$4.40 |
| 460 81 | 6.0 | .236 | 150 | 6.0 | 0.9 | .035 | 268 | 10.5 | .23 | 10 | \$4.90 |
| 460 82 | 6.0 | .236 | 200 | 8.0 | 0.9 | .035 | 318 | 12.5 | .25 | 10 | \$5.10 |
| 460 84* | 6.5 | .236 | 40 | 1.5 | 1.2 | .047 | 90 | 3.5 | .08 | 10 | \$4.30 |
| 460 85 | 6.5 | .236 | 150 | 6.0 | 1.2 | .047 | 268 | 10.5 | .23 | 10 | \$5.20 |
| 460 87 | 8.0 | .315 | 150 | 6.0 | 1.2 | .047 | 268 | 10.5 | .26 | 10 | \$6.40 |
| 460 89 | 10.0 | .393 | 200 | 8.0 | 1.6 | .063 | 318 | 12.5 | .35 | 10 | \$6.70 |

* Stubby screwdriver with Wiha Powerhandle - 46084
** Cabinet Tip



461 Phillips Screwdriver, With Wiha-3K Series Handle
Blade chrome-vanadium-molybdenum steel, hardened, nickel-plated. Wiha-3k Ergo handle, cushion grip.

| Item No. | mm | mm | Inch | mm | Inch | lbs. | pkg. | Each |
|----------|----|-----|------|-----|------|------|------|--------|
| 461 47 | 0 | 60 | 2.4 | 145 | 5.7 | .06 | 10 | \$3.30 |
| 461 50 | 1 | 80 | 3.1 | 187 | 7.3 | .13 | 10 | \$3.70 |
| 461 51 | 1 | 200 | 8.0 | 307 | 12.0 | .16 | 10 | \$4.60 |
| 461 53 | 2 | 100 | 4.0 | 218 | 8.5 | .21 | 10 | \$5.00 |
| 461 52 | 2 | 150 | 6.0 | 268 | 10.5 | .23 | 10 | \$5.20 |
| 461 57 | 2 | 200 | 8.0 | 318 | 12.5 | .25 | 10 | \$5.30 |
| 461 62* | 2 | 40 | 1.6 | 90 | 3.5 | .08 | 10 | \$3.90 |
| 461 67 | 3 | 150 | 6.0 | 268 | 10.5 | .31 | 10 | \$6.40 |

* Stubby screwdriver with Wiha Powerhandle



461 90 Set 6 Pcs. Phillips Screwdriver Set
Blade chrome-vanadium-molybdenum steel, hardened, nickel-plated. Wiha-3k Ergo handle, cushion grip.

| Item No. | Size | mm | Size | mm | lbs. |
|----------|--------|----|------|--------|---------------|
| 461 90 | 461 47 | 0 | 60 | 461 52 | 2 150 1.27 |
| | 461 50 | 1 | 80 | 461 62 | 2 40 Each |
| | 461 53 | 2 | 100 | 461 67 | 3 150 \$26.98 |



Made in Germany

Toll Free: (800) 494-6104

Click image to view web page

Wiha 3K Series Screwdrivers and Sets



460 94 Set 6 Pcs. Slotted & Phillips

Blade chrome-vanadium-molybdenum steel, hardened, nickel-plated. Wiha-3k Ergo handle, cushion grip.

| Item No. | Slotted mm | Phillips mm | Size | mm | lbs. |
|----------|------------|-------------|------|--------|-------------------|
| 460 94 | 460 70 | 3.0 | 100 | 461 50 | 1 80 .91 |
| | 460 75 | 4.5 | 100 | 461 52 | 2 150 Each |
| | 460 78 | 5.5 | 125 | | \$23.70 |
| | 460 85 | 6.5 | 150 | | |



460 97 Set 8 Pcs. Slotted & Phillips

Blade chrome-vanadium-molybdenum steel, hardened, nickel-plated. Wiha-3k Ergo handle, cushion grip.

| Item No. | Slotted mm | Phillips mm | Size | mm | lbs. |
|----------|------------|-------------|------|--------|----------------------|
| 460 97 | 460 70 | 3.0 | 100 | 461 50 | 1 80 1.70 |
| | 460 75 | 4.5 | 100 | 461 53 | 2 100 |
| | 460 80 | 6.0 | 100 | 461 62 | 2 40 Each |
| | 460 87 | 8.0 | 150 | 461 67 | 3 150 \$37.68 |



460 95 Set 5 Pcs. Slotted & Phillips

Blade chrome-vanadium-molybdenum steel, hardened, nickel-plated. Wiha-3k Ergo handle, cushion grip.

| Item No. | Slotted mm | Phillips mm | Size | mm | lbs. |
|----------|------------|-------------|------|--------|----------------------|
| 460 95 | 460 75 | 4.5 | 100 | 461 47 | 0 60 1.04 |
| | 460 80 | 6.0 | 100 | 461 50 | 1 80 Each |
| | | | | 461 53 | 2 100 \$20.40 |



460 98 Set 4 Pcs. Slotted & Phillips

Blade chrome-vanadium-molybdenum steel, hardened, nickel-plated. Wiha-3k Ergo handle, cushion grip.

| Item No. | Slotted mm | Phillips mm | Size | mm | .98 lbs. |
|----------|------------|-------------|------|--------|----------------------|
| 460 98 | 460 75 | 4.5 | 100 | 461 50 | 1 80 Each |
| | 460 80 | 6.0 | 100 | 461 53 | 2 100 \$17.30 |



484 01 1/4" Bit holding Screwdriver, With Wiha-Ergo 3K Handle

Magnetic, holds bit and screw. Retainer out of stainless steel. Shaft CVM tool steel, nickel plated.

| Item No. | Size | mm | Inch | mm | Inch | lbs. | pkg. | Each |
|----------|------|-----|------|-----|------|------|------|---------------|
| 484 01 | 1/4" | 125 | 5.0 | 144 | 5.6 | .24 | 1 | \$7.98 |

See Additional Bit Holders On Page 154



Made in Germany

www.wihatools.com

Click image to view web page

Wiha Cabinet Tip and Screw Holding Screwdrivers



186 Slotted Cabinet Tip Screwdriver, With Wiha-Square Handle

Blade chrome-vanadium-molybdenum steel, hardened, nickel-plated. Tip parallel to shaft. Series includes extra long dimensions for screws in difficult to reach locations. Wiha-square handle cellulose-acetate, impact resistant.

| Item | Icons | No. | mm | Inch | mm | Inch | mm | Inch | lbs. | pkg. | Each | |
|--------|-------|------|------|------|------|------|------|------|------|------|------|--------|
| 186 01 | ☐ | 2.0 | .078 | 40 | 1.6 | 0.40 | .016 | 100 | 4.0 | .02 | 10 | \$2.00 |
| 186 03 | ☐ | 2.5 | .098 | 50 | 2.0 | 0.40 | .016 | 110 | 4.3 | .02 | 10 | \$2.10 |
| 186 06 | ☐ | 3.0 | .118 | 75 | 3.0 | 0.50 | .020 | 150 | 5.9 | .05 | 10 | \$2.30 |
| 186 09 | ☐ | 3.0 | .118 | 100 | 4.0 | 0.50 | .020 | 175 | 6.9 | .06 | 10 | \$2.40 |
| 186 12 | ☐ | 3.0 | .118 | 150 | 6.0 | 0.50 | .020 | 225 | 8.9 | .06 | 10 | \$2.50 |
| 186 15 | ☐ | 3.0 | .118 | 200 | 8.0 | 0.50 | .020 | 285 | 11.2 | .08 | 10 | \$2.80 |
| 186 24 | ☐ | 4.0 | .157 | 100 | 4.0 | 0.60 | .024 | 185 | 7.3 | .08 | 10 | \$2.90 |
| 186 27 | ☐ | 4.0 | .157 | 150 | 6.0 | 0.60 | .024 | 235 | 9.3 | .10 | 10 | \$3.30 |
| 186 30 | ☐ | 4.0 | .157 | 200 | 8.0 | 0.60 | .024 | 285 | 11.2 | .11 | 10 | \$3.90 |
| 186 42 | ☐ | 5.0 | .196 | 100 | 4.0 | 0.70 | .028 | 195 | 7.7 | .13 | 10 | \$4.20 |
| 186 45 | ☐ | 5.0 | .196 | 150 | 6.0 | 0.70 | .028 | 245 | 9.6 | .15 | 10 | \$4.20 |
| 186 48 | ☐ | 5.0 | .196 | 200 | 8.0 | 0.70 | .028 | 295 | 11.6 | .17 | 10 | \$4.40 |
| 186 51 | ☐ | 5.0 | .196 | 300 | 12.0 | 0.70 | .028 | 395 | 15.6 | .20 | 10 | \$5.00 |
| 186 54 | ☐ | 6.0 | .236 | 100 | 4.0 | 0.90 | .035 | 205 | 8.1 | .19 | 10 | \$5.30 |
| 186 57 | ☐ | 6.0 | .236 | 150 | 6.0 | 0.90 | .035 | 255 | 10.0 | .21 | 10 | \$5.80 |
| 186 60 | ☐ | 6.0 | .236 | 200 | 8.0 | 0.90 | .035 | 305 | 12.0 | .24 | 10 | \$5.90 |
| 186 63 | ☐ | 6.0 | .236 | 300 | 12.0 | 0.90 | .035 | 405 | 15.9 | .29 | 10 | \$6.40 |
| 186 72 | ☐ | 8.0 | .315 | 200 | 8.0 | 1.20 | .047 | 315 | 12.4 | .32 | 10 | \$8.20 |
| 186 78 | ☐ | 8.0 | .315 | 300 | 12.0 | 1.20 | .047 | 415 | 16.3 | .39 | 10 | \$9.10 |
| 186 81 | ☐ | 10.0 | .393 | 200 | 8.0 | 1.60 | .063 | 315 | 12.4 | .37 | 10 | \$9.30 |

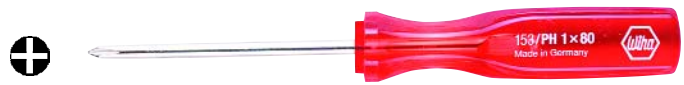

153 Phillips Screwdriver, With Wiha-Square Handle

Blade chrome-vanadium-molybdenum steel, hardened, nickel-plated. Wiha-square handle cellulose-acetate, impact resistant.

| Item | Icons | No. | Size | mm | Inch | mm | Inch | mm | Inch | lbs. | pkg. | Each |
|--------|-------|-----|------|------|------|------|------|------|------|------|------|--------|
| 153 05 | ☐ | 0 | 60 | 2.4 | 3.0 | .118 | 135 | 5.3 | .05 | 10 | 10 | \$2.80 |
| 153 10 | ☐ | 1 | 80 | 3.0 | 4.5 | .177 | 175 | 6.9 | .11 | 10 | 10 | \$4.10 |
| 153 15 | ☐ | 1 | 200 | 8.0 | 4.5 | .177 | 295 | 11.6 | .15 | 10 | 10 | \$5.10 |
| 153 25 | ☐ | 2 | 100 | 4.0 | 6.0 | .236 | 205 | 8.1 | .18 | 10 | 10 | \$5.50 |
| 153 30 | ☐ | 2 | 250 | 10.0 | 6.0 | .236 | 355 | 14.0 | .27 | 10 | 10 | \$7.30 |
| 153 35 | ☐ | 2 | 350 | 13.7 | 6.0 | .236 | 455 | 17.8 | .33 | 10 | 10 | \$8.30 |
| 153 40 | ☐ | 3 | 150 | 6.0 | 8.0 | .315 | 265 | 10.4 | .33 | 10 | 10 | \$8.00 |



222 Pozidriv® Screwdriver, With Wiha-Square Handle

Blade chrome-vanadium-molybdenum steel, hardened, nickel-plated. Wiha-square handle cellulose-acetate, impact resistant.

| Item | Icons | No. | Size | mm | Inch | mm | Inch | mm | Inch | lbs. | pkg. | Each |
|--------|-------|-----|------|-----|------|-----|------|------|------|------|------|--------|
| 222 20 | ☐ | 1 | 200 | 7.8 | 4.5 | .17 | 295 | 11.6 | .15 | 10 | 10 | \$6.70 |
| 222 30 | ☐ | 2 | 250 | 9.8 | 6.0 | .23 | 355 | 13.9 | .27 | 10 | 10 | \$7.70 |



Clamping sleeve to hold screw

394 Slotted Screw-Holding Screwdriver, With Wiha-Square Handle

Blade CVM steel, hardened, black finish. Clamping sleeve polyimide. Wiha-square handle cellulose-acetate, impact resistant.

| Item | Icons | No. | mm | Inch | mm | Inch | mm | Inch | lbs. | pkg. | Each |
|--------|-------|-----|------|------|-----|------|------|------|------|------|---------|
| 394 25 | ☐ | 2.5 | .098 | 75 | 3.0 | 160 | 6.3 | .07 | 10 | 10 | \$12.90 |
| 394 30 | ☐ | 3.0 | .118 | 100 | 4.0 | 195 | 7.6 | .11 | 10 | 10 | \$13.50 |
| 394 40 | ☐ | 4.0 | .157 | 125 | 5.0 | 230 | 9.0 | .18 | 10 | 10 | \$17.40 |
| 394 50 | ☐ | 5.0 | .196 | 150 | 6.0 | 265 | 10.4 | .25 | 10 | 10 | \$20.70 |
| 394 60 | ☐ | 6.0 | .236 | 175 | 6.9 | 290 | 11.4 | .30 | 10 | 10 | \$23.50 |



Clamping sleeve to hold screw

395 Phillips Screw-Holding Screwdriver, With Wiha-Square Handle

Blade CVM steel, hardened, black finish. Clamping sleeve polyimide. Wiha-square handle cellulose-acetate, impact resistant.

| Item | Icons | No. | Size | mm | Inch | mm | Inch | lbs. | pkg. | Each |
|--------|-------|-----|------|-----|------|------|------|------|------|---------|
| 395 00 | ☐ | 0 | 100 | 4.0 | 195 | 7.6 | .11 | 10 | 10 | \$14.70 |
| 395 01 | ☐ | 1 | 125 | 5.0 | 230 | 9.0 | .18 | 10 | 10 | \$20.20 |
| 395 02 | ☐ | 2 | 175 | 7.0 | 290 | 11.4 | .30 | 10 | 10 | \$24.70 |

Wiha Offset Screwdrivers



161 Phillips Offset Screwdriver, With Handle

For working in confined spaces. Blade CVM special steel, hardened, chrome-plated. Handle high quality plastic, impact resistant.

| Item | Icons | No. | Size | mm | Inch | mm | Inch | lbs. | pkg. | Each |
|--------|-------|-------|------|------|------|------|------|------|------|---------|
| 161 12 | ☐ | 1 + 2 | 125 | 4.9 | 5.5 | .217 | .08 | 10 | 10 | \$4.40 |
| 161 34 | ☐ | 3 + 4 | 200 | 10.0 | 8.0 | .315 | .33 | 10 | 10 | \$10.30 |

207 Slotted Offset Screwdriver, With Handle

| Item | Icons | No. | mm | Inch | mm | Inch | mm | Inch | lbs. | pkg. | Each |
|--------|-------|------|------|------|-----|------|------|------|------|------|---------|
| 207 15 | ☐ | 6.5 | 1/4 | 125 | 5.0 | 1.2 | .047 | .07 | 10 | 10 | \$4.70 |
| 207 20 | ☐ | 8.0 | 5/16 | 150 | 6.0 | 1.2 | .047 | .15 | 10 | 10 | \$6.70 |
| 207 25 | ☐ | 10.0 | 3/8 | 175 | 6.9 | 1.6 | .063 | .23 | 10 | 10 | \$11.70 |



207 90 5 Pc. Set Slotted & Phillips Offset Screwdrivers

| Item | Icons | Set includes the following drivers: | | Each |
|--------|-------|-------------------------------------|-------------------------|---------|
| 207 90 | ☐ | lbs. | Slotted: 6.5, 8.0, 10.0 | Each |
| 207 90 | ☐ | .86 | Phillips: 1 + 2, 3 + 4 | \$36.98 |



Made in Germany

Toll Free: (800) 494-6104

Click image to view web page

Wiha Dynamic Series

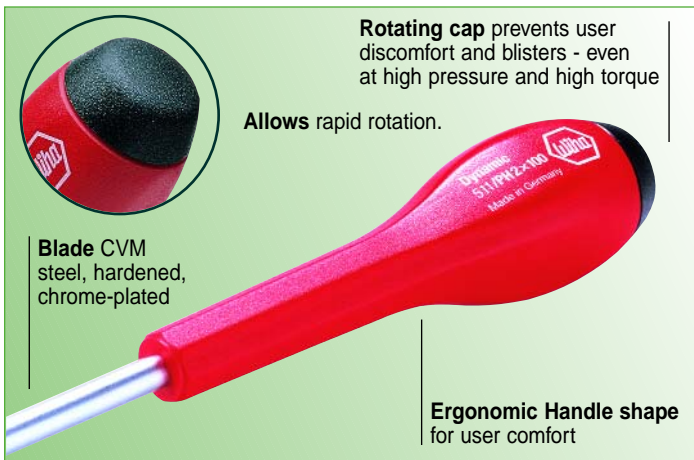

Rotating cap prevents user discomfort and blisters - even at high pressure and high torque

Allows rapid rotation.

Blade CVM steel, hardened, chrome-plated

Ergonomic Handle shape for user comfort



510 Slotted Screwdriver, With Wiha-Dynamic Handle

Blade high alloy chrome-vanadium-molybdenum steel, hardened, chrome-plated. Wiha-Dynamic-handle high quality plastic.

| Item No. | Blade | mm | Inch | mm | Inch | mm | Inch | mm | Inch | lbs. | pkg. | Each |
|----------|-------|-----|------|-----|------|-----|------|-----|------|------|------|---------|
| 510 20 | + | 2.0 | .078 | 65 | 2.5 | 0.4 | .016 | 165 | 6.5 | .04 | 10 | \$4.90 |
| 510 25 | + | 2.5 | .098 | 75 | 3.0 | 0.4 | .016 | 175 | 6.9 | .04 | 10 | \$5.10 |
| 510 30 | + | 3.0 | .118 | 80 | 3.1 | 0.5 | .020 | 180 | 7.1 | .05 | 10 | \$5.40 |
| 510 35 | + | 3.5 | .139 | 100 | 3.9 | 0.6 | .024 | 205 | 8.1 | .07 | 10 | \$6.00 |
| 510 40 | + | 4.0 | .157 | 100 | 3.9 | 0.8 | .031 | 205 | 8.1 | .08 | 10 | \$6.50 |
| 510 55 | + | 5.5 | .216 | 125 | 5.0 | 1.0 | .039 | 236 | 9.3 | .14 | 10 | \$8.40 |
| 510 65 | + | 6.5 | .255 | 150 | 6.0 | 1.2 | .047 | 267 | 10.5 | .20 | 10 | \$10.20 |
| 510 80 | + | 8.0 | .315 | 175 | 7.0 | 1.2 | .047 | 267 | 11.6 | .29 | 10 | \$13.20 |



511 Phillips Screwdriver, With Wiha-Dynamic Handle

| Item No. | Blade | Size | mm | Inch | mm | Inch | mm | Inch | lbs. | pkg. | Each |
|----------|-------|------|-----|------|-----|------|-----|------|------|------|--------|
| 511 05 | + | 0 | 60 | 2.3 | 3.0 | 1/8 | 160 | 6.3 | .05 | 10 | \$5.80 |
| 511 10 | + | 1 | 80 | 3.1 | 4.5 | 3/16 | 191 | 7.5 | .11 | 10 | \$6.80 |
| 511 20 | + | 2 | 100 | 4.0 | 6.0 | 1/4 | 217 | 8.5 | .17 | 10 | \$9.10 |

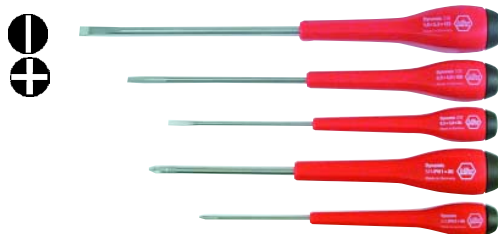

510 90 Set 5 Pc. Slotted & Phillips, Wiha-Dynamic Handle

| Item No. | Blade | mm | Inch | mm | Inch | Size | mm | Inch | lbs. | pkg. | Each |
|----------|-------|-----|------|-----|------|------|----|------|------|------|---------|
| 510 90 | + | 3.0 | .118 | 80 | 3.1 | 0 | 60 | 2.3 | .68 | 1 | \$33.06 |
| | + | 4.0 | .157 | 100 | 3.9 | 1 | 80 | 3.1 | | | |
| | + | 5.5 | .216 | 125 | 4.9 | | | | | | |

510 92 Set 4 Pc. Slotted Drivers, Wiha-Dynamic Handle

Set Includes: 2.0, 3.5, 5.5, 6.5 Each \$28.98

Wiha Magnetizer/Demagnetizer

Magnetize or Demagnetize tools and small parts instantly.

Shatterproof Box is made from high quality plastic.

Uses 2 C5 industrial permanent magnets



(+) to Magnetize

(-) to Demagnetize

(Parts under 1" Length or 1/8" Diameter may not demagnetize)

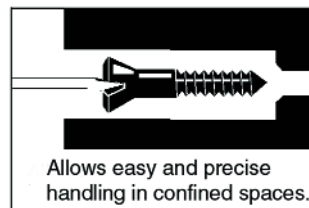

Allows easy and precise handling in confined spaces.

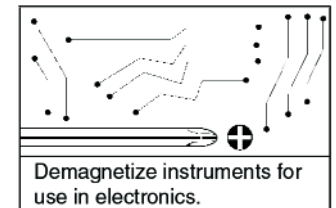

Demagnetize instruments for use in electronics.



Collects metal items from inaccessible places.

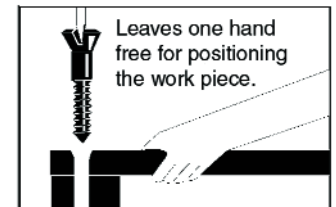

Leaves one hand free for positioning the work piece.

400 10 Magnetizer and Demagnetizer

To magnetize and demagnetize steel screwdriver blades, tweezers and similar tools. Box high quality plastic, shock-resistant, green, cadmium free.

Application:

To magnetize, lead tool slowly through the (+) opening, to demagnetize guide tool slowly through the (-) opening.



| Item No. | Dimensions | lbs. | Each |
|----------|--------------------|------|--------|
| 400 10 | 2.1" x 2.0" x 1.1" | .30 | \$7.18 |



Made in Germany

www.wihatools.com

Click image to view web page

SYSTEM 6

Handles • Blades • Sets

Rotating cap turns freely while applying pressure to tight fasteners.

Collet lock eliminates loose fitting blades.

Narrow diameter allows 40% more turning clearance. Gives high visibility to fastener.

Long, slender grips for extended reach



108 10 SYS 6 Standard Dynamic Handle, high quality plastic, impact resistant.

Advantages:

- Accepts all SYSTEM 6 blades securely.
- Collet lock allows for quick & easy adjustment.

| Item | | | | | | | |
|--------|-----|-----|------|------|------|------|--------|
| No. | mm | mm | Inch | mm | Inch | lbs. | Each |
| 108 10 | 6.0 | 135 | 5.3 | 15.2 | .60 | .16 | \$5.00 |



108 20 SYSTEM 6 ESD Safe Dynamic Handle, Conductive, high quality plastic, impact resistant. **Advantages:**

- Accepts all SYSTEM 6 blades.
- Surface resistant 10⁶ to 10⁹ Ohms.
- Safe for working on ESD sensitive parts.
- Collet lock holds blade securely in place.

| Item | | | | | | | |
|--------|-----|-----|------|------|------|------|--------|
| No. | mm | mm | Inch | mm | Inch | lbs. | Each |
| 108 20 | 6.0 | 135 | 5.3 | 15.2 | .60 | .16 | \$5.50 |



108 30 SYSTEM 6 MicroFinish Non-Slip Grip Dynamic Handle, high quality plastic, impact resistant.

Advantages:

- Accepts all SYSTEM 6 blades.
- MicroFinish Handle with non-slip surface.
- Collet lock holds blade securely in place.

| Item | | | | | | | |
|--------|-----|-----|------|------|------|------|--------|
| No. | mm | mm | Inch | mm | Inch | lbs. | Each |
| 108 30 | 6.0 | 135 | 5.3 | 15.2 | .60 | .16 | \$6.00 |



281 04 SYSTEM 6 Handle With Hex Bolster Wiha-SoftFinish® impact resistant.

Hex bolster for additional torque.

Advantages:

- Ergonomic cushion grip
- Quick slide in blade change
- Hex bolster to loosen tight screws

| Item | | | | | | |
|--------|-----|-----|------|------|------|--------|
| No. | mm | mm | Inch | mm | Inch | Each |
| 281 04 | 6.0 | 122 | 4.8 | 36.0 | 1.41 | \$7.68 |



481 06 SYSTEM 6 Magnetizer/Demagnetizer Handle. Wiha-Hex bolster for additional torque.

Advantages:

- Ergo Soft grip panels for comfort
- Built in blade Magnetizer/Demagnetizer

| Item | | | | | | | |
|--------|-----|-----|------|----|------|------|---------|
| No. | mm | mm | Inch | mm | Inch | lbs. | Each |
| 481 06 | 6.0 | 109 | 4.1 | 29 | 1.1 | .14 | \$11.98 |



281 01 Magnetic T-handle for SYSTEM 6 Interchangeable Blades. Wiha T-handle impact resistant. **Advantages:**

- Ergo handle design for high torque capacity.
- Powerful rare earth magnet holds blade.

| Item | | | | | | | |
|--------|-----|-------|------|----|------|------|--------|
| No. | mm | mm | Inch | mm | Inch | lbs. | Each |
| 281 01 | 6.0 | 98.75 | 3.89 | 34 | 1.33 | .12 | \$5.98 |

Smooth, high torque, silent ratchet handle

Pistol Grip Handle ergonomic design with free running mechanism. Instant clutch engagement allows constant turning pressure on the fastener.

Hex Retainer for SYSTEM 6 blades



No release of handle is needed, change of direction can be made with index finger and thumb. **Allows for** quick adjustment to right, left or fixed turning.

Opens a new generation of easier torque transmission



282 00 Topra Handle Pistol grip design. Wiha-Topra handle, high quality plastic, impact resistant. Rated to 200in/lbs. Fits all Wiha SYSTEM 6 blades.

| Item | | | | | | | |
|--------|-----|-----|------|----|------|------|---------|
| No. | mm | mm | Inch | mm | Inch | lbs. | Each |
| 282 00 | 6.0 | 100 | 3.94 | 85 | 3.35 | .48 | \$29.98 |

SYSTEM 6 Starter Kit



100 93 SYSTEM 6 Slotted & Phillips Interchangeable Blade Set, 6 Pcs. in Durable Pouch. Set includes SoftFinish® handle & 5 interchangeable blades.

| Item | | | |
|---|--------|----------|--------------|
| No. | 100 93 | lbs. .75 | Each \$25.98 |
| Slotted: 3.0, 4.5, 6.0mm Phillips: 1, 2 | | | |
| Wiha SoftFinish® Dynamic Handle | | | |
| Pouch holds up to 11 SYSTEM 6 blades | | | |



Made in Germany

Toll Free: (800) 494-6104

Click image to view web page

Wiha SYSTEM 6 Blades



100 SYSTEM 6 Slotted Interchangeable

Blade, high alloy CVM steel, hardened, corrosion protected. Slotted on 6mm SYSTEM 6 Hex. Blade length 140mm/5.5".

| Item | | | | | |
|--------|-----|------|------|--------|--|
| No. | mm | lbs. | pkg. | Each | |
| 100 00 | 3.0 | .10 | 1 | \$4.68 | |
| 100 03 | 4.0 | .10 | 1 | \$4.68 | |
| 100 06 | 4.5 | .10 | 1 | \$4.68 | |
| 100 09 | 5.0 | .10 | 1 | \$4.68 | |
| 100 12 | 6.0 | .10 | 1 | \$4.68 | |
| 100 15 | 6.5 | .10 | 1 | \$4.68 | |
| 100 18 | 8.0 | .10 | 1 | \$4.68 | |



101 SYSTEM 6 Phillips Interchangeable

Blade, high alloy CVM steel, hardened, corrosion protected. Phillips on 6mm SYSTEM 6 Hex. Blade length 140mm/5.5".

| Item | | | | | |
|--------|------|------|------|--------|--|
| No. | Size | lbs. | pkg. | Each | |
| 101 00 | 0 | .10 | 1 | \$4.68 | |
| 101 03 | 1 | .10 | 1 | \$4.68 | |
| 101 06 | 2 | .10 | 1 | \$4.68 | |
| 101 09 | 3 | .10 | 1 | \$4.68 | |



102 SYS 6 Pozidriv® Interchangeable

Blade, high alloy CVM steel, hardened, corrosion protected. Pozidriv on 6mm SYSTEM 6 Hex. Blade length 140mm/5.5".

| Item | | | | | |
|--------|------|------|------|--------|--|
| No. | Size | lbs. | pkg. | Each | |
| 102 00 | 0 | .10 | 1 | \$5.48 | |
| 102 03 | 1 | .10 | 1 | \$5.48 | |
| 102 06 | 2 | .10 | 1 | \$5.48 | |
| 102 09 | 3 | .10 | 1 | \$5.48 | |



103 SYS 6 Hex Inch Interchangeable

Blade, high alloy CVM steel, hardened, corrosion protected. Hex Inch on 6mm SYSTEM 6 Hex. Blade length 140mm/5.5".

| Item | | | | | |
|--------|------|------|------|--------|--|
| No. | Inch | lbs. | pkg. | Each | |
| 103 00 | 3/32 | .10 | 1 | \$4.68 | |
| 103 03 | 7/64 | .10 | 1 | \$4.68 | |
| 103 06 | 1/8 | .10 | 1 | \$4.68 | |
| 103 09 | 9/64 | .10 | 1 | \$4.68 | |
| 103 12 | 5/32 | .10 | 1 | \$4.68 | |
| 103 15 | 3/16 | .10 | 1 | \$4.68 | |
| 103 18 | 7/32 | .10 | 1 | \$4.68 | |

104 SYS 6 Hex Metric Interchangeable

| Item | | | | | |
|--------|-----|------|------|--------|--|
| No. | mm | lbs. | pkg. | Each | |
| 104 00 | 2.5 | .10 | 1 | \$4.68 | |
| 104 03 | 3.0 | .10 | 1 | \$4.68 | |
| 104 06 | 4.0 | .10 | 1 | \$4.68 | |
| 104 09 | 5.0 | .10 | 1 | \$4.68 | |
| 104 12 | 6.0 | .10 | 1 | \$4.68 | |



105-106 SYS 6 Nut Driver Inch & Metric

Interchangeable Blade, CVM steel, hardened, corrosion protected. Nut Drivers on 6mm SYSTEM 6 Hex. Blade length 140mm/5.5".

| Item | | | | | |
|--------|-------|------|------|--------|--|
| No. | mm | lbs. | pkg. | Each | |
| 105 00 | 3/16 | .11 | 1 | \$5.30 | |
| 105 03 | 7/32 | .11 | 1 | \$5.30 | |
| 105 06 | 1/4 | .12 | 1 | \$5.30 | |
| 105 09 | 9/32 | .12 | 1 | \$5.30 | |
| 105 12 | 5/16 | .13 | 1 | \$5.30 | |
| 105 15 | 11/32 | .13 | 1 | \$5.30 | |
| 105 18 | 3/8 | .14 | 1 | \$5.30 | |
| 105 21 | 7/16 | .16 | 1 | \$5.30 | |
| 105 24 | 1/2 | .18 | 1 | \$5.30 | |

Metric

| Item | | | | | |
|--------|------|------|------|--------|--|
| No. | mm | lbs. | pkg. | Each | |
| 106 00 | 4.0 | .10 | 1 | \$5.30 | |
| 106 03 | 4.5 | .10 | 1 | \$5.30 | |
| 106 06 | 5.0 | .11 | 1 | \$5.30 | |
| 106 09 | 5.5 | .11 | 1 | \$5.30 | |
| 106 12 | 6.0 | .11 | 1 | \$5.30 | |
| 106 15 | 7.0 | .13 | 1 | \$5.30 | |
| 106 18 | 8.0 | .13 | 1 | \$5.30 | |
| 106 21 | 9.0 | .13 | 1 | \$5.30 | |
| 106 24 | 10.0 | .15 | 1 | \$5.30 | |
| 106 27 | 11.0 | .15 | 1 | \$5.30 | |
| 106 30 | 12.0 | .15 | 1 | \$5.30 | |
| 106 33 | 13.0 | .17 | 1 | \$5.30 | |

These blades can also be used in Topra Ratchet handle



107 SYSTEM 6 TORX® Interchangeable

Blade, high alloy CVM tool steel, hardened, corrosion protected. TORX® on 6mm SYS 6 Hex. Blade length 140mm/5.5".

| Item | | | | | |
|--------|------|------|------|--------|--|
| No. | Size | lbs. | pkg. | Each | |
| 107 00 | T8 | .10 | 1 | \$4.68 | |
| 107 03 | T9 | .10 | 1 | \$4.68 | |
| 107 06 | T10 | .10 | 1 | \$4.68 | |
| 107 09 | T15 | .10 | 1 | \$4.68 | |
| 107 12 | T20 | .10 | 1 | \$4.68 | |
| 107 15 | T25 | .10 | 1 | \$4.68 | |
| 107 18 | T27 | .10 | 1 | \$4.68 | |
| 107 21 | T30 | .10 | 1 | \$4.68 | |
| 107 24 | T40 | .11 | 1 | \$4.68 | |

These blades can also be used in Topra Ratchet handle



111 SYSTEM 6 Tamper Resistant TORX®

Interchangeable Blade, high alloy CVM tool steel, hardened, corrosion protected. TORX® on 6mm SYS 6 Hex. Blade length 140mm/5.5".

| Item | | | | | |
|--------|------|------|------|--------|--|
| No. | Size | lbs. | pkg. | Each | |
| 111 03 | TR7 | .09 | 1 | \$5.98 | |
| 111 05 | TR8 | .09 | 1 | \$5.98 | |
| 111 07 | TR9 | .09 | 1 | \$5.98 | |
| 111 09 | TR10 | .09 | 1 | \$5.98 | |
| 111 12 | TR15 | .09 | 1 | \$5.98 | |
| 111 15 | TR20 | .09 | 1 | \$5.98 | |
| 111 18 | TR25 | .09 | 1 | \$5.98 | |
| 111 20 | TR27 | .09 | 1 | \$5.98 | |
| 111 24 | TR30 | .11 | 1 | \$5.98 | |

Magnetize & Demagnetize



Magnetize & Demagnetize



481 90 SYSTEM 6 Slotted & Phillips

Interchangeable Blade Set, 7 Pcs. in Durable Pouch. Set includes Magnetizer/Demagnetizer handle & 6 interchangeable blades.

| Item | | | |
|------|--------|------|---------|
| No. | 481 90 | lbs. | Each |
| | | .75 | \$36.98 |

Slotted: 3.0, 4.0, 6.0mm Phillips: 0, 1, 2
Wiha Magnetizer/Demagnetizer Handle



Made in Germany

www.wihatools.com

Click image to view web page

Wiha SYSTEM 6 Longer Length Blades



284 SYSTEM 6 Slotted Reversible Blade, high alloy CVM steel, hardened, chrome plated, Wiha vapor Chrome-Top finish on tips. Slotted on 6mm SYSTEM 6 Hex. Blade length 175mm/6.89".

| Item | | | | |
|--------|-----|-------|------|--------|
| No. | mm | mm | lbs. | Each |
| 284 06 | 4.0 | + 6.0 | .09 | \$7.00 |
| 284 07 | 5.5 | + 6.5 | .09 | \$7.00 |



284 SYSTEM 6 Phillips Reversible Blade, high alloy CVM steel, hardened, chrome plated, Wiha vapor Chrome-Top finish on tips. Phillips on 6mm SYSTEM 6 Hex. Blade length 175mm/6.89".

| Item | | | | |
|--------|------|------|------|--------|
| No. | Size | Size | lbs. | Each |
| 284 12 | 1 | + 2 | .08 | \$7.00 |



284 SYSTEM 6 Pozidriv® Reversible Blade, high alloy CVM steel, hardened, chrome plated, Wiha vapor Chrome-Top finish on tips. Pozidriv on 6mm SYSTEM 6 Hex. Blade length 175mm/6.89".

| Item | | | | |
|--------|------|------|------|--------|
| No. | Size | Size | lbs. | Each |
| 284 22 | 1 | + 2 | .08 | \$7.00 |



284 SYSTEM 6 Combined Hex Reversible Blade, high alloy CVM steel, hardened, chrome plated, Wiha vapor Chrome-Top finish on tips. One side hex, other side ballpoint hex. Hex Metric on 6mm SYSTEM 6 Hex. Blade length 175mm/6.89".

| Item | | | | |
|--------|-----|-------|------|--------|
| No. | mm | mm | lbs. | Each |
| 284 31 | 2.5 | + 2.5 | .08 | \$7.70 |
| 284 32 | 3.0 | + 3.0 | .09 | \$7.70 |
| 284 33 | 4.0 | + 4.0 | .09 | \$7.70 |
| 284 34 | 5.0 | + 5.0 | .09 | \$7.70 |
| 284 35 | 6.0 | + 6.0 | .09 | \$7.70 |



284 SYS 6 Nut Driver Metric Blade, high alloy CVM steel, hardened, chrome plated.

| Item | | | | | |
|--------|------|-----|-----|------|--------|
| No. | mm | mm | mm | lbs. | Each |
| 284 38 | 4.0 | 175 | 6.0 | .09 | \$6.60 |
| 284 41 | 5.5 | 175 | 6.0 | .09 | \$6.60 |
| 284 42 | 6.0 | 175 | 6.0 | .09 | \$6.60 |
| 284 43 | 7.0 | 176 | 6.0 | .11 | \$6.80 |
| 284 44 | 8.0 | 176 | 6.0 | .12 | \$6.80 |
| 284 46 | 10.0 | 177 | 6.0 | .13 | \$6.80 |
| 284 49 | 13.0 | 177 | 6.0 | .16 | \$7.00 |



284 SYSTEM 6 TORX® Reversible Blade, high alloy CVM steel, hardened, chrome plated, Wiha vapor Chrome-Top finish on tips. TORX® on 6mm SYSTEM 6 Hex. Blade length 175mm/6.89".

| Item | | | | |
|--------|------|-------|------|--------|
| No. | Size | Size | lbs. | Each |
| 284 51 | T6 | + T8 | .08 | \$7.40 |
| 284 52 | T7 | + T9 | .08 | \$7.40 |
| 284 53 | T10 | + T15 | .08 | \$7.40 |
| 284 54 | T20 | + T25 | .08 | \$7.40 |
| 284 55 | T30 | + T40 | .09 | \$7.40 |



284 SYSTEM 6 Combined Slotted/Phillips Reversible Blade, high alloy CVM steel, hardened, chrome-plated, Wiha vapor Chrome-Top finish on tips. Slotted/Phillips on 6mm SYSTEM 6 Hex. Blade length 175mm/6.89".

| Item | | | | |
|--------|-----|------|------|--------|
| No. | mm | Size | lbs. | Each |
| 284 73 | 4.0 | + 1 | .08 | \$7.00 |
| 284 74 | 6.0 | + 2 | .09 | \$7.00 |
| 284 75 | 6.5 | + 3 | .09 | \$7.00 |

Wiha Adapter Blades



109 00 Extension Blade for SYS 6 Blades Shaft CVM steel, hardened, corrosion protected. Ball retainer blade extension. Allows you to extend all SYSTEM 6 blades an additional 100mm.

| Item | | | | | | |
|--------|------|-----|-----|------|------|--------|
| No. | Size | mm | mm | lbs. | pkg. | Each |
| 109 00 | 6.0 | 140 | 6.0 | .13 | 1 | \$5.20 |



109 10 SYSTEM 6 Magnetic Adapter Blade for 1/4" Bits. Shaft chrome-vanadium-molybdenum steel, hardened, corrosion protected. Bits retainer made from stainless steel.

| Item | | | | | | |
|--------|------|-----|-----|------|------|--------|
| No. | Size | mm | mm | lbs. | pkg. | Each |
| 109 10 | 1/4" | 140 | 6.0 | .12 | 1 | \$5.20 |

780 20 SYSTEM 6 Longer Length Magnetic Adapter Blade for 1/4" Bits. Shaft chrome-vanadium-molybdenum steel, hardened, corrosion protected. Bits retainer made from stainless steel.

| Item | | | | | | |
|--------|------|-----|-----|------|------|--------|
| No. | Size | mm | mm | lbs. | pkg. | Each |
| 780 20 | 1/4" | 170 | 6.0 | .14 | 1 | \$5.20 |



109 20 SYSTEM 6 Adapter Blade for 1/4" Drive Sockets. Shaft chrome-vanadium-molybdenum steel, hardened, chrome-plated, square drive with ball retainer.

| Item | | | | | | |
|--------|------|-----|-----|------|------|--------|
| No. | Size | mm | mm | lbs. | pkg. | Each |
| 109 20 | 1/4" | 132 | 6.0 | .13 | 1 | \$5.20 |



100 93 SYSTEM 6 Slotted & Phillips Interchangeable Blade Set, 6 Pcs. in Durable Pouch. Set includes SoftFinish® handle & 5 interchangeable blades.

| Item | | |
|---|--------|-----------------------|
| No. | 100 93 | lbs. .75 Each \$25.98 |
| Slotted: 3.0, 4.5, 6.0mm Phillips: 1, 2 | | |
| Wiha SoftFinish® Dynamic Handle | | |



Made in Germany

Toll Free: (800) 494-6104

Click image to view web page

Wiha ESD Safe SYSTEM 6 Sets



101 91 SYSTEM 6 Slotted & Phillips Interchangeable Blade Set, 8 Pcs. in Durable Pouch. Set includes ESD Safe Collet Lock handle & 7 interchangeable blades.

| | | | |
|--------------------------------|----------------------|----------|--------------|
| Item | ↔ | | |
| No. | 101 91 | lbs. .75 | Each \$32.98 |
| Slotted: | 3.0, 4.0, 6.0, 8.0mm | | |
| Phillips: | 0, 1, 2 | | |
| ▲ Wiha ESD Safe Dynamic Handle | | | |

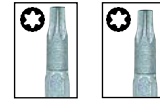

SYS 6 SYS 4

107 91 SYSTEM 6/4 TORX® Interchangeable Blade Set, 9 Pcs. in Durable Pouch. Set includes ESD Safe Precision and Dynamic handles and 7 Wiha interchangeable blades.

| | | | |
|---|------------------------------|----------|--------------|
| Item | ↔ | | |
| No. | 107 91 | lbs. .71 | Each \$43.98 |
| SYS 4: | T5, T6, T7, T8, T9, T10, T15 | | |
| SYS 6: | T20, T25, T30 | | |
| ▲ ESD Safe Precision & Dynamic Handle Set | | | |

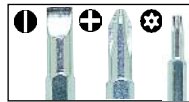

101 95 SYSTEM 6 Slotted/Phillips & Tamper Resistant TORX® Interchangeable Blade Set, 12 Pcs. in Durable Pouch. Set includes ESD Safe Collet Lock handle & 11 interchangeable blades.

| | | | |
|--------------------------------|---------------------------|----------|--------------|
| Item | ↔ | | |
| No. | 101 95 | lbs. .92 | Each \$53.98 |
| Slotted: | 3.0, 4.5, 6.0mm | | |
| Phillips: | 0, 1, 2 | | |
| TR TORX®: | TR7, TR8, TR9, TR10, TR15 | | |
| ▲ Wiha ESD Safe Dynamic Handle | | | |

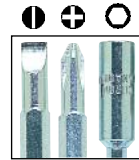

109 51 SYSTEM 6 Inch Nut Drivers, Slotted & Phillips Interchangeable Blade Set, includes 4" Blade Extension, 14 Pcs. in Durable Pouch. Set includes ESD Safe Dynamic Collet Lock handle and 13 Wiha interchangeable blades.

| | | | |
|---------------------------|---|-----------|--------------|
| Item | ↔ | | |
| No. | 109 51 | lbs. 1.14 | Each \$55.98 |
| Slotted: | 4.5, 6.5 | | |
| Phillips: | 1, 2 | | |
| Nut Driver Inch: | 3/16, 7/32, 1/4, 9/32, 5/16, 11/32, 3/8, 7/16, 1/2" | | |
| ▲ ESD Safe Dynamic Handle | | | |

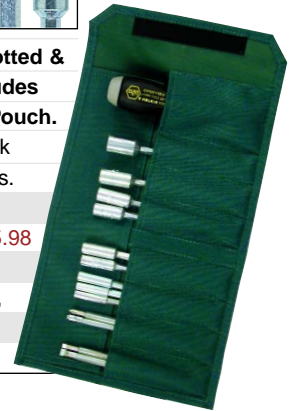

106 91 SYS 6 Nut Driver Metric Interchangeable Blade Set, 11 Pcs. in Durable Pouch. Set includes ESD Safe Collet Lock handle & 10 blades.

| | | | |
|--------------------------------|--|-----------|--------------|
| Item | ↔ | | |
| No. | 106 91 | lbs. 1.16 | Each \$43.98 |
| Metric: | 4.0, 4.5, 5.0, 5.5, 6.0, 7.0, 8.0, 9.0, 10.0, 11.0mm | | |
| ▲ Wiha ESD Safe Dynamic Handle | | | |



111 91 SYSTEM 6 Tamper Resistant TORX® Interchangeable Blade Set, 10 Pcs. in Durable Pouch. Set includes ESD Safe Precision and Dynamic handles & 9 interchangeable blades.

| | | | |
|---------------------------|---|----------|--------------|
| Item | ↔ | | |
| No. | 111 91 | lbs. .84 | Each \$53.98 |
| Tamper Resistant: | TR7, TR8, TR9, TR10, TR15, TR20, TR25, TR27, TR30 | | |
| ▲ ESD Safe Dynamic Handle | | | |





Made in Germany

www.wihatools.com

Click image to view web page

Wiha SYSTEM 6 Topra Set



Wiha Topra Ratchet Handle

282 Sets Topra Ratchet

Pistol Grip Handle with ergonomic design has free running mechanism. Instant clutch engagement allows constant turning pressure on the fastener.



282 94 Topra Reversible Set, 11 Pcs. in Metal Box. Wiha Topra Pistol Grip Ratchet handle fits SYSTEM 6 blades. 10 reversible longer length blades included.

| Item | No. | Handle Description | Each |
|------|--------|---|----------|
| | 282 94 | Topra Ratcheting Handle | \$120.98 |
| | | Longer Length (175mm) Reversible Blades: | |
| | | Slotted Sizes: 4.0 + 6.0, 5.5 + 6.5 | |
| | | Phillips Sizes: 1 + 2 | |
| | | Pozidriv® Sizes: 1 + 2 | |
| | | Hex/Ball Hex Sizes: 4.0 + 4.0, 5.0 + 5.0, 6.0 + 6.0 | |
| | | TORX® Sizes: T10 + T15, T20 + T25, T30 + T40 | |
| | | lbs. 3.18 | |



Wiha Awls and Offset Screwdrivers



300 01 Square Reaming Awl, With Hardwood Handle
 Blade chrome-vanadium-molybdenum steel, hardened, nickel-plated. Blade extending through handle, with striking plate. Hardwood handle out of beechwood.

| Item | No. | mm | Inch | mm | Inch | mm | Inch | lbs. | pkg. | Each |
|------|--------|-----|------|-----|------|-----|------|------|------|--------|
| | 300 01 | 6.0 | .236 | 100 | 4.0 | 190 | 7.5 | .16 | 10 | \$7.00 |



300 02 Square Reaming Awl, With Plastic Handle
 Blade chrome-vanadium-molybdenum steel, hardened, nickel-plated. Round handle cellulose-acetate, impact resistant.

| Item | No. | mm | Inch | mm | Inch | mm | Inch | lbs. | pkg. | Each |
|------|--------|-----|------|-----|------|-----|------|------|------|--------|
| | 300 02 | 6.0 | .236 | 100 | 4.0 | 185 | 7.3 | .15 | 10 | \$5.60 |



301 01 Round Awl, With Hardwood Handle
 Blade CVM steel, hardened, nickel-plated. Blade extending through handle, with striking plate. Hardwood handle out of beechwood.

| Item | No. | mm | Inch | mm | Inch | mm | Inch | lbs. | pkg. | Each |
|------|--------|-----|------|-----|------|-----|------|------|------|--------|
| | 301 01 | 6.0 | .236 | 100 | 4.0 | 190 | 7.5 | .17 | 10 | \$6.90 |



301 02 Round Awl, With Plastic Handle
 Blade chrome-vanadium-molybdenum steel, hardened, nickel-plated. Plastic handle cellulose-acetate, impact resistant.

| Item | No. | mm | Inch | mm | Inch | mm | Inch | lbs. | pkg. | Each |
|------|--------|-----|------|-----|------|-----|------|------|------|--------|
| | 301 02 | 6.0 | .236 | 100 | 4.0 | 185 | 7.3 | .15 | 10 | \$5.50 |



Made in Germany

www.wihatools.com

Click image to view web page

Wiha Insulated Screwdrivers with SoftFinish Cushion Grip Handle

Insulation Test Standards:

Insulation according to IEC 900, ASTM F-1505-01, New VDE 0682/part 201, DIN 7437, Draft 11/90

Responds to OSHA's use specification 29 CFR1910



Each tool individually tested to 10,000 volts and certified to 1000 Volt ac or 1500 Volt dc.

SoftFinish® handle solid molded core with soft outer cushion grip. 40% more torque than conventional handles

Insulation molded directly onto the blade for permanent bonding.

Blade CVM tool steel, hardened to average 58/60RC.



1000Volt

320 Slotted Screwdriver, With Wiha-SoftFinish® Handle
 Insulation According to ASTM F-1505-01, New VDE Specification 0682/part 201 and IEC 900, up to 1000 Volt. "GS" Sign.
 Individually Tested. Blade high alloy chrome-vanadium-molybdenum steel, hardened, black finish. Insulation molded directly onto blade.
 Wiha-SoftFinish® handle, multi-component, cushion grip.

| Item | + | + | + | + | + | + | + | + | + |
|--------|------|------|-----|------|-----|------|------|------|---------|
| No. | mm | Inch | mm | Inch | mm | Inch | lbs. | pkg. | Each |
| 320 05 | 2.0 | .078 | 60 | 3.0 | 164 | 6.5 | .05 | 10 | \$4.30 |
| 320 10 | 2.5 | .098 | 75 | 3.0 | 179 | 7.1 | .06 | 10 | \$4.30 |
| 320 12 | 3.0 | .118 | 100 | 4.0 | 204 | 8.0 | .07 | 10 | \$4.30 |
| 320 15 | 3.5 | .139 | 100 | 4.0 | 204 | 8.0 | .07 | 10 | \$4.60 |
| 320 24 | 4.5 | .177 | 125 | 5.0 | 236 | 9.3 | .12 | 10 | \$5.50 |
| 320 26 | 5.5 | .216 | 175 | 7.0 | 293 | 11.5 | .21 | 10 | \$6.20 |
| 320 39 | 6.5 | .255 | 150 | 6.0 | 268 | 10.6 | .21 | 10 | \$7.60 |
| 320 42 | 8.0 | .315 | 175 | 7.0 | 299 | 11.8 | .34 | 10 | \$9.70 |
| 320 45 | 10.0 | .393 | 200 | 8.0 | 318 | 12.5 | .39 | 10 | \$12.50 |



1000Volt

321 Phillips Screwdriver, With Wiha-SoftFinish® Handle
 Insulation According to ASTM F-1505-01, New VDE Specification 0682/part 201 and IEC 900, up to 1000 Volt. "GS" Sign.
 Individually Tested. Blade high alloy chrome-vanadium-molybdenum steel, hardened, black finish. Insulation molded directly onto blade.
 Wiha-SoftFinish® handle, multi-component, cushion grip.

| Item | + | + | + | + | + | + | + | + | + |
|--------|------|-----|------|-----|------|------|------|--------|---|
| No. | Size | mm | Inch | mm | Inch | lbs. | pkg. | Each | |
| 321 00 | 0 | 60 | 2.4 | 164 | 6.5 | .06 | 10 | \$4.60 | |
| 321 01 | 1 | 80 | 3.0 | 191 | 7.5 | .12 | 10 | \$5.30 | |
| 321 02 | 2 | 100 | 4.0 | 218 | 8.6 | .20 | 10 | \$6.70 | |
| 321 03 | 3 | 150 | 6.0 | 268 | 10.6 | .34 | 10 | \$9.50 | |

Warning!
 Insulated tools are not intended for use on live or energized circuits. Always disconnect and de-energize all equipment & circuits. **NEVER!** work on live or energized circuits or equipment.

Use & Care Guide For Insulated Tools:
 Store tools to minimize risk of damage to insulation
 Inspect insulation prior to each use of any insulated tool
 If you doubt the integrity of the insulation destroy the tool or have it retested
 Use insulated tools where the ambient temperature is between -20 to +70° C
 Have a qualified safety technician inspect and re-certify tools annually for safe use



Made in Germany

Toll Free: (800) 494-6104

Click image to view web page

Wiha Insulated Screwdriver Sets



1000Volt

320 90 Set 4 Pcs. Slotted & Phillips

| Item No. | Slotted (mm) | Phillips (mm) | Size | mm | lbs. |
|----------|--------------|---------------|--------|-------|--------------|
| 320 90 | 320 15 | 3.5 100 0.6 | 321 01 | 1 80 | .76 |
| | 320 24 | 4.5 125 1.0 | 321 02 | 2 100 | Each \$22.98 |



1000Volt

320 93 Set 10 Pcs. Slotted & Phillips

| Item No. | Slotted (mm) | Phillips (mm) | Size | mm | lbs. |
|----------|--------------|---------------|--------|-------|--------------|
| 320 93 | 320 05 | 2.0 60 | 321 00 | 0 60 | 1.63 |
| | 320 10 | 2.5 75 | 321 01 | 1 80 | |
| | 320 12 | 3.0 100 | 321 02 | 2 100 | |
| | 320 15 | 3.5 100 | 321 03 | 3 150 | |
| | 320 24 | 4.5 125 | | | Each \$49.98 |
| | 320 39 | 6.5 150 | | | |



1000Volt

320 91 Set 5 Pcs. Slotted & Phillips

| Item No. | Slotted (mm) | Phillips (mm) | Size | mm | lbs. |
|----------|--------------|---------------|--------|-------|--------------|
| 320 91 | 320 12 | 3.0 100 0.6 | 321 01 | 1 80 | 1.31 |
| | 320 24 | 4.5 125 1.0 | 321 02 | 2 100 | Each \$28.80 |
| | 320 39 | 6.5 150 1.2 | | | |



1000Volt

320 92 Set 6 Pcs. Slotted & Phillips

| Item No. | Slotted (mm) | Phillips (mm) | Size | mm | lbs. |
|----------|--------------|---------------|--------|-------|--------------|
| 320 92 | 320 15 | 3.5 100 0.6 | 321 01 | 1 80 | 1.31 |
| | 320 24 | 4.5 125 1.0 | 321 02 | 2 100 | Each \$38.70 |
| | 320 39 | 6.5 150 1.2 | 321 03 | 3 150 | |

1000Volt



321 90 Set 15 Pcs. Slotted, Phillips & Inch Nut Drivers

| Item No. | Slotted (mm) | Phillips (mm) | Size | mm | lbs. |
|----------|--------------|---------------|--------|---------|---------------|
| 321 90 | 321 01 | 1 80 | 320 42 | 8.0 175 | 6.0 |
| | 321 02 | 2 100 | 320 39 | 6.5 150 | |
| | 321 03 | 3 150 | 320 24 | 4.5 125 | |
| | | | 320 15 | 3.5 100 | |
| | 322 64 | 1/4 5.0 | 320 12 | 3.0 100 | |
| | 322 67 | 5/16 5.0 | 320 10 | 2.5 75 | |
| | 322 70 | 3/8 5.0 | 320 05 | 2.0 60 | |
| | 322 73 | 7/16 5.0 | | | Each \$155.98 |
| | 322 76 | 1/2 5.0 | | | |



Made in Germany

www.wihatools.com

Click image to view web page

Wiha Insulated Nut Drivers



1000Volt

322 Nut Driver, With Wiha-SoftFinish® Handle Insulation According to ASTM F-1505-01, New VDE Specification 0682/part 201 and IEC 900, up to 1000 Volt. "GS" Sign. Individually Tested.

Blade CVM steel, hardened. Insulation molded directly onto blade. Deep drawn 1" socket. Wiha-SoftFinish® handle, multi-component.

| Item No. | mm | mm | mm | Inch | lbs. | pkg. | Each |
|----------|------|-----|-----|------|------|------|---------|
| 322 06 | 4.0 | 125 | 236 | 9.3 | .15 | 10 | \$7.70 |
| 322 09 | 5.0 | 125 | 236 | 9.3 | .16 | 10 | \$7.90 |
| 322 12 | 5.5 | 125 | 236 | 9.3 | .16 | 10 | \$7.90 |
| 322 15 | 6.0 | 125 | 236 | 9.3 | .16 | 10 | \$7.90 |
| 322 18 | 7.0 | 125 | 243 | 9.3 | .25 | 10 | \$8.90 |
| 322 21 | 8.0 | 125 | 243 | 9.6 | .25 | 10 | \$9.50 |
| 322 24 | 9.0 | 125 | 243 | 9.6 | .25 | 10 | \$10.70 |
| 322 27 | 10.0 | 125 | 243 | 9.6 | .27 | 10 | \$11.30 |
| 322 30 | 11.0 | 125 | 243 | 9.6 | .37 | 10 | \$11.60 |
| 322 33 | 12.0 | 125 | 243 | 9.6 | .38 | 10 | \$11.90 |
| 322 36 | 13.0 | 125 | 243 | 9.6 | .39 | 10 | \$12.20 |



1000Volt

322 Nut Driver, With Wiha-SoftFinish® Handle. Inch sizes.

| Item No. | Inch | Inch | mm | Inch | lbs. | pkg. | Each |
|----------|------|------|-----|------|------|------|---------|
| 322 43 | 3/32 | 5.0 | 236 | 8.5 | .14 | 10 | \$6.80 |
| 322 46 | 7/64 | 5.0 | 236 | 8.5 | .14 | 10 | \$6.80 |
| 322 49 | 1/8 | 5.0 | 236 | 8.5 | .14 | 10 | \$6.80 |
| 322 52 | 9/64 | 5.0 | 236 | 8.5 | .15 | 10 | \$7.70 |
| 322 55 | 5/32 | 5.0 | 236 | 8.5 | .15 | 10 | \$7.70 |
| 322 58 | 3/16 | 5.0 | 236 | 8.5 | .15 | 10 | \$7.90 |
| 322 61 | 7/32 | 5.0 | 236 | 8.5 | .16 | 10 | \$7.90 |
| 322 64 | 1/4 | 5.0 | 243 | 8.5 | .24 | 10 | \$7.90 |
| 322 67 | 5/16 | 5.0 | 243 | 8.9 | .25 | 10 | \$9.50 |
| 322 70 | 3/8 | 5.0 | 243 | 9.3 | .26 | 10 | \$10.70 |
| 322 73 | 7/16 | 5.0 | 243 | 9.3 | .36 | 10 | \$11.60 |
| 322 76 | 1/2 | 5.0 | 243 | 9.3 | .39 | 10 | \$12.20 |
| 322 78 | 9/16 | 5.0 | 243 | 9.3 | .39 | 10 | \$12.40 |
| 322 80 | 5/8 | 5.0 | 243 | 9.5 | .41 | 10 | \$13.70 |

Warning!

Insulated tools are not intended for use on live or energized circuits. Always disconnect and de-energize all equipment & circuits. **NEVER!** work on live or energized circuits or equipment.

Use & Care Guide For Insulated Tools:

Store tools to minimize risk of damage to insulation
 Inspect insulation prior to each use of any insulated tool
 If you doubt the integrity of the insulation destroy the tool or have it retested
 Use insulated tools where the ambient temperature is between -20 to +70° C
 Have a qualified safety technician inspect and re-certify tools annually for safe use



1000Volt

322 91 Set 5 Pcs. Nut Driver Metric Sizes

| Item No. | mm | mm | mm | mm | mm | lbs. |
|----------|--------|-----|-----|--------|------|---------|
| 322 91 | 322 15 | 6.0 | 125 | 322 24 | 9.0 | 1.36 |
| | 322 18 | 7.0 | 125 | 322 27 | 10.0 | Each |
| | 322 21 | 8.0 | 125 | | | \$48.76 |



1000Volt

322 93 Set 7 Pcs. Nut Driver Metric Sizes

| Item No. | mm | Inch | mm | Inch | lbs. | |
|----------|--------|------|-----|--------|------|---------|
| 322 93 | 322 09 | 5.0 | 125 | 322 21 | 2.05 | |
| | 322 12 | 5.5 | 125 | 322 27 | 10.0 | 125 |
| | 322 15 | 6.0 | 125 | 322 36 | 13.0 | 125 |
| | 322 18 | 7.0 | 125 | | | Each |
| | | | | | | \$66.98 |



1000Volt

322 92 Set 5 Pcs. Nut Driver Inch Sizes

| Item No. | Inch | Inch | Inch | Inch | lbs. | |
|----------|--------|------|------|--------|------|---------|
| 322 92 | 322 61 | 7/32 | 5.0 | 322 70 | 1.52 | |
| | 322 64 | 1/4 | 5.0 | 322 76 | 1/2 | 5.0 |
| | 322 67 | 5/16 | 5.0 | | | Each |
| | | | | | | \$48.66 |



1000Volt

322 94 Set 7 Pcs. Nut Driver Inch Sizes

| Item No. | Inch | Inch | Inch | Inch | lbs. | |
|----------|--------|------|------|--------|------|---------|
| 322 94 | 322 58 | 3/16 | 5.0 | 322 70 | 2.24 | |
| | 322 61 | 7/32 | 5.0 | 322 73 | 7/16 | 5.0 |
| | 322 64 | 1/4 | 5.0 | 322 76 | 1/2 | 5.0 |
| | 322 67 | 5/16 | 5.0 | | | Each |
| | | | | | | \$69.98 |



Made in Germany

Toll Free: (800) 494-6104

Click image to view web page

Wiha Insulated TORX® Screwdrivers



325 TORX® Screwdriver, With Wiha-SoftFinish® Handle
 Insulation According to ASTM F-1505-01, New VDE Specification 0682/part 201 and IEC 900, up to 1000 Volt. "GS" Sign.
 Individually Tested. Blade high alloy cvm steel, hardened, black finish. Insulation molded directly onto blade.

| Item No. | Size | mm | Inch | mm | Inch | lbs. | pkg. | Each |
|----------|------|-----|------|-----|------|------|------|---------|
| 325 05 | T5 | 60 | 2.4 | 164 | 6.5 | .06 | 10 | \$4.80 |
| 325 11 | T6 | 60 | 2.4 | 164 | 6.5 | .06 | 10 | \$4.80 |
| 325 16 | T7 | 60 | 2.4 | 164 | 6.5 | .06 | 10 | \$4.80 |
| 325 21 | T8 | 60 | 2.4 | 164 | 6.5 | .06 | 10 | \$4.80 |
| 325 26 | T9 | 60 | 2.4 | 164 | 6.5 | .06 | 10 | \$4.80 |
| 325 31 | T10 | 60 | 2.4 | 164 | 6.5 | .06 | 10 | \$4.80 |
| 325 36 | T15 | 80 | 3.0 | 191 | 7.5 | .12 | 10 | \$5.90 |
| 325 41 | T20 | 80 | 3.0 | 191 | 7.5 | .12 | 10 | \$5.90 |
| 325 46 | T25 | 80 | 3.0 | 198 | 7.8 | .17 | 10 | \$5.90 |
| 325 51 | T27 | 100 | 4.0 | 218 | 8.6 | .20 | 10 | \$7.60 |
| 325 56 | T30 | 100 | 4.0 | 218 | 8.6 | .20 | 10 | \$7.60 |
| 325 61 | T40 | 150 | 6.0 | 274 | 10.8 | .30 | 10 | \$10.70 |
| 325 66 | T45 | 150 | 6.0 | 274 | 10.8 | .35 | 10 | \$11.20 |

Wiha Insulated Pliers - Comfort Grip Handle



328 96 31 Pc. Pliers & Screwdriver Set. Insulation According to VDE 0682/part 201, DIN EN 60900, IEC 900, ASTM F-1505-01, up to 1000 volt. "GS" Sign. Individually Tested. Pliers drop-forged from special tool steel, individually high frequency induction hardened, chrome/nickel plated, mirror-polished. Set includes 6ft. Fiber glass folding ruler.

328 96 31 Pc. Master Electricians Insulated Set

Item# **32896** Set Includes: lbs. 12.75 Each \$488.98

| | |
|-------------------------------|---------------------------------|
| 32806 - 6.5" Long Nose Pliers | 32832 - 6.5" Side Cutter |
| 32808 - 8" Long Nose | 32838 - 8" High Leverage Cutter |
| 32816 - 7" Linemans | 32860 - 6.5" Stripping Pliers |
| 32820 - 9" Combination Pliers | 32870 - 6.5" Round Nose Pliers |
| 32255 - Ins Nut Driver 5/32" | 32005 - Insulated Slotted 2.0 |
| 32258 - Ins Nut Driver 3/16" | 32010 - Insulated Slotted 2.5 |
| 32261 - Ins Nut Driver 7/32" | 32012 - Insulated Slotted 3.0 |
| 32264 - Ins Nut Driver 1/4" | 32015 - Insulated Slotted 3.5 |
| 32267 - Ins Nut Driver 5/16" | 32024 - Insulated Slotted 4.0 |
| 32270 - Ins Nut Driver 3/8" | 32026 - Insulated Slotted 5.5 |
| 32273 - Ins Nut Driver 7/16" | 32039 - Insulated Slotted 6.5 |
| 32276 - Ins Nut Driver 1/2" | 32042 - Insulated Slotted 8.0 |
| 32278 - Ins Nut Drivers 9/16" | 32045 - Insulated Slotted 10.0 |
| 32100 - Insulated Phillips #0 | 32102 - Insulated Phillips #2 |
| 32101 - Insulated Phillips #1 | 32103 - Insulated Phillips #3 |



325 90 Set 6 Pcs. TORX®

| Item No. | Size | mm | Inch | mm | Inch | lbs. | pkg. | Each |
|----------|--------|-----|------|--------|------|------|------|---------|
| 325 90 | 325 21 | T8 | 60 | 325 36 | T15 | 80 | | .83 |
| | 325 26 | T9 | 60 | 325 41 | T20 | 80 | | Each |
| | 325 31 | T10 | 60 | 325 46 | T25 | 80 | | \$32.12 |



326 50 Retaining Ring Bit Holding Screwdriver, With Wiha-SoftFinish® Handle Insulation According to ASTM F-1505-01, New VDE Specification 0682/part 201 and IEC 900, up to 1000 Volt. "GS" Sign. Individually Tested. Blade high alloy CVM steel, hardened, black finish. Insulation molded directly onto blade. Wiha-SoftFinish® handle, multi-component. Holds 1/4" drive bits.

| Item No. | Size | mm | Inch | mm | Inch | lbs. | pkg. | Each |
|----------|------|----|------|-----|------|------|------|---------|
| 326 50 | 1/4" | 60 | 2.4 | 164 | 6.5 | .06 | 10 | \$11.98 |



380 25 Magnetic Bit Holder, 1/4", Wiha-Powerhandle, Insulated, cellulose-acetate, impact resistant. Snap-lock rotatable cap. Chambered bit holder equipped with transparent selector for easy selection of bits. 1/4" bit holder, shielded, magnetic, holds bit and screw. Cavity holds up to 6 bits. (bits not included)

| Item No. | Size | mm | Inch | mm | Inch | lbs. | pkg. | Each |
|----------|------|-----|------|-----|------|------|------|---------|
| 380 25 | 1/4 | 120 | 4.7 | 230 | 9.0 | .26 | 1 | \$13.18 |

Insulation meets VDE, ASTM & IEC specifications

See Additional Bit Holders
 On Page 154



Made in Germany

www.wihatools.com

Click image to view web page

Wiha Insulated Pliers with High Visibility Comfort Grip Handle



⚡ 1000Volt

328 91 10 Pc. Plier & Screwdriver Set. Insulation According to VDE 0682/part 201, DIN EN 60900, IEC 900, ASTM F-1505-01, ⚡ up to 1000 volt. "GS" Sign. Individually Tested. Pliers drop-forged from special tool steel, individually high frequency induction hardened, chrome and nickel plated, mirror-polished. In zipper carry case.

| | | |
|--------------------------------------|-------------------------------|----------------------|
| Item# 32891 Set Includes: | wt. 5.44 | Each \$277.00 |
| 32818 - 8" Combination Pliers | 32808 - 8" Long Nose | |
| 32838 - 8" Side Cutter | 32848 - 6.75" Cable Cutters | |
| 32860 - 6.5" Universal Wire Stripper | | |
| 32101 - Insulated Phillips #1 | 32024 - Insulated Slotted 4.5 | |
| 32102 - Insulated Phillips #2 | 32039 - Insulated Slotted 6.5 | |
| 32103 - Insulated Phillips #3 | | |



⚡ 1000Volt

328 92 10 Pc. Plier & Screwdriver Set. Insulation According to VDE 0682/part 201, DIN EN 60900, IEC 900, ASTM F-1505-01, ⚡ up to 1000 volt. "GS" Sign. Individually Tested. Pliers drop-forged from special tool steel, individually high frequency induction hardened, chrome and nickel plated, mirror-polished. In molded tool box.

| | | |
|----------------------------------|-------------------------------|----------------------|
| Item# 32892 Set Includes: | wt. 6.64 | Each \$185.98 |
| 32804 - 8" Bent Nose | 32818 - 8" Combination Pliers | |
| 32806 - 6.5" Long Nose | 32832 - 6.5" Side Cutter | |
| 32100 - Insulated Phillips #0 | 32012 - Insulated Slotted 3.0 | |
| 32101 - Insulated Phillips #1 | 32024 - Insulated Slotted 4.5 | |
| 32102 - Insulated Phillips #2 | 32039 - Insulated Slotted 6.5 | |



⚡ 1000Volt

328 95 14 Pc. Plier & Screwdriver Set. Insulation According to VDE 0682/part 201, DIN EN 60900, IEC 900, ASTM F-1505-01, ⚡ up to 1000 volt. "GS" Sign. Individually Tested. Pliers drop-forged from special tool steel, individually high frequency induction hardened, chrome and nickel plated, mirror-polished. In zipper carry case.

| | | |
|----------------------------------|---------------------------------|----------------------|
| Item# 32895 Set Includes: | wt. 6.50 | Each \$278.98 |
| 32808 - 8" Long Nose | 32832 - 6.5" Side Cutter | |
| 32820 - 9" Combination Plier | 32838 - 8" High Leverage Cutter | |
| 32860 - 6.5" Stripping Plier | 32010 - Insulated Slotted 2.5 | |
| 32101 - Insulated Phillips #1 | 32012 - Insulated Slotted 3.0 | |
| 32102 - Insulated Phillips #2 | 32015 - Insulated Slotted 3.5 | |
| 32103 - Insulated Phillips #3 | 32024 - Insulated Slotted 4.5 | |
| 32005 - Insulated Slotted 2.0 | 32039 - Insulated Slotted 6.5 | |



328 94 12 Pc. Plier & Screwdriver Set. In molded tool box.

| | | |
|----------------------------------|-------------------------------|----------------------|
| Item# 32894 Set Includes: | wt. 7.73 | Each \$214.98 |
| 32804 - 8" Bent Nose | 32818 - 8" Combination Pliers | |
| 32806 - 6.5" Long Nose | 32832 - 6.5" Side Cutter | |
| 32024 - Insulated Slotted 4.5 | 32264 - Ins Nut Driver 1/4" | |
| 32039 - Insulated Slotted 6.5 | 32267 - Ins Nut Driver 5/16" | |
| 32101 - Insulated Phillips #1 | 32270 - Ins Nut Driver 3/8" | |
| 32102 - Insulated Phillips #2 | 32276 - Ins Nut Driver 1/2" | |



Made in Germany

Toll Free: (800) 494-6104

Click on page number to view product

Wiha Pliers & Cutters Index

| | Description | Page |
|--|--|-------|
| | Insulated Combination Pliers | 88 |
| | Insulated Diagonal Cutters Heavy Duty | 89 |
| | Insulated Diagonal Cutters High Leverage | 89 |
| | Insulated Cable Cutter | 89 |
| | Insulated Bent Nose Pliers | 90 |
| | Insulated Long Nose Pliers | 90 |
| | Insulated Round Nose Plier | 91 |
| | Insulated Stripping Plier | 91 |
| | Insulated Tool Sets | 85-86 |

COMFORTGRIP PLIERS/CUTTERS

| | | |
|--|-----------------------|----|
| | Combination Pliers | 92 |
| | Stripping Pliers | 92 |
| | Long Nose Pliers | 93 |
| | Bent Long Nose Pliers | 93 |
| | Flat Nose Pliers | 93 |
| | Adjustable Pliers | 94 |
| | Diagonal Cutters | 95 |
| | ComfortGrip Tool Sets | 95 |

STANDARD GRIP PLIERS/CUTTERS

| | | |
|--|-----------------------------|----|
| | Combination Pliers | 96 |
| | Stripping Pliers | 96 |
| | Long Nose Pliers | 97 |
| | Bent Long Nose Pliers | 97 |
| | Long Flat Nose Pliers | 97 |
| | Long Round Nose Pliers | 97 |
| | Adjustable Pliers | 98 |
| | High Leverage Cable Cutters | 99 |
| | Diagonal Cutters | 99 |

| | | |
|--|----------------------------------|-----|
| | High Leverage End Cutting Pliers | 99 |
| | Carpenter's End Nippers | 100 |
| | Mason Nippers | 100 |
| | Retaining Ring Pliers | 101 |
| | Wiha Standard Plier/Cutter Sets | 98 |

ESD SAFE PLIERS/CUTTERS

| | | |
|--|--|---------|
| | ESD Safe Diagonal Cutters Small Tapered Head | 104 |
| | ESD Safe Diagonal Cutters Wide Tapered Head | 105 |
| | ESD Safe Diagonal Cutters Oval Heads | 105-106 |
| | ESD Safe Diagonal Cutters With Carbide Cutters | 106 |
| | ESD Safe Oblique Angled Cutters | 107 |
| | ESD Safe Oblique Front Cutters | 107 |
| | ESD Safe End Cutters | 108 |
| | ESD Safe Snipe/Bent Nose Pliers | 108 |
| | ESD Safe Needle Nose Pliers | 109 |
| | ESD Safe Short Round Nose | 109 |
| | ESD Safe Short Flat Nose | 109 |
| | ESD Safe Tool Sets | 109 |

Wiha Maxiflex Rulers Index

| | Description | Page |
|--|--------------------|------|
| | Inch/Metric Rulers | 102 |



Made in Germany

www.wihatools.com

Click image to view web page

Wiha Insulated Pliers & Cutters

Insulation Standards:

DIN EN 60900, IEC 900, ASTM F-1505-01, and or According to VDE 0682/part 201.

1000V

Cutters additionally induction hardened

NEW
from Wiha

Chrome finish for long lasting corrosion protection

Soft grip ergonomically designed handle body

Safety slip guard

Two Component Anti-slip handle material for a comfortable and safe grip

Tools Meet 10,000 Volt test Standards Certified to 1000 Volt ac or 1500 Volt dc.

Insulated Combination Lineman's Pliers



1000volt

328 Combination Pliers. Insulation According to VDE 0682/part 201, DIN EN 60900, IEC 900, ASTM F-1505-01, up to 1000 volt. "GS" Sign. Individually Tested. DIN ISO 5746 Extra long cutting edge for flat & round cables. Serrated jaws. Cutting edges additionally induction hardened to approx. 60HRC. Special CV tool steel forgings, Chrome finish. Use For gripping and holding as well as cutting soft and hard wires and cables. Two component Soft grip ergonomic handles.

| Item No. | | ↔ mm | ↔ Inch | Cutting Capacity Copper AWG | 🔌 | 🔌 | Pkg. wt. | Each |
|---------------|-----------|------|--------|--------------------------------|---|---|----------|----------------|
| 328 14 | Z01016006 | 160 | 6.5 | #10 | 1 | | .53 | \$28.98 |
| 328 16 | Z01018006 | 180 | 7.0 | #9 | 1 | | .58 | \$34.98 |
| 328 18 | Z01020006 | 200 | 8.0 | #8 | 1 | | .72 | \$38.98 |

Insulated High Leverage Combination Pliers

Lineman's

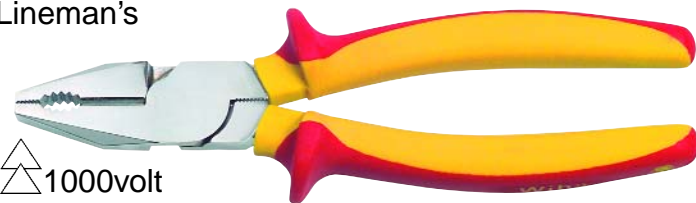

1000volt

With Lower Serrated Pulling Jaws

328 High Leverage Combination Pliers. Insulation According to DIN EN 60900, IEC 900, ASTM F-1505-01, up to 1000 volt. "GS" Sign. Individually Tested. DIN ISO 5746

Extra long cutting edge for flat and round cables. Serrated upper jaws and lower pulling jaws. Cutting edges additionally induction hardened to approx. 64HRC. C 60 Special tool steel. Use For gripping, pulling & holding as well as cutting wires and cables ranging in hardness from soft to extremely hard. Two component Soft grip ergonomic handles.

| Item No. | | ↔ mm | ↔ Inch | Cutting Capacity Copper AWG | 🔌 | 🔌 | Pkg. wt. | Each |
|---------------|-----------|------|--------|--------------------------------|---|---|----------|----------------|
| 328 20 | Z02022506 | 225 | 9.0 | #4 | 1 | | .79 | \$39.98 |

Warning! Insulated tools are not intended for use on live or energized circuits. Always disconnect and de-energize all equipment & circuits. **NEVER!** work on live or energized circuits or equipment.

Use & Care Guide For Insulated Tools:

- Store tools to minimize risk of damage to insulation
- Inspect insulation prior to each use of any insulated tool
- If you doubt the integrity of the insulation destroy the tool or have it retested
- Use insulated tools where the ambient temperature is between -20 to +70° C
- Have a qualified safety technician inspect and re-certify tools annually for safe use



Made in Germany

Toll Free: (800) 494-6104

Click image to view web page

Wiha Insulated Pliers & Cutters

Insulated Diagonal Cutters



1000volt

328 Diagonal Cutters. Insulation According to VDE 0682/part 201, DIN EN 60900, IEC 900, ASTM F-1505-01, up to 1000 volt. "GS" Sign. Individually Tested. DIN ISO 5749 Low wear lap joint, riveted and able to withstand high levels of load. Lightweight action, clean cutting. Long term cutting is achieved through additional inductive hardening to approx. 60 HRC. Special tool steel hardened and tempered. For soft & medium hard wire. 32832 & 32834 for soft, hard & piano wire.

| Item No. | | mm | Inch | Cutting Capacity Copper AWG | Pkg. wt. | Each |
|----------|-----------|-----|------|--------------------------------|----------|---------|
| 328 30 | Z12014006 | 140 | 5.5 | #6 | 1 .47 | \$28.98 |
| 328 32 | Z12016006 | 160 | 6.5 | #6 | 1 .49 | \$35.98 |
| 328 34 | Z12018006 | 180 | 7.0 | #6 | 1 .62 | \$39.98 |

Insulated High Leverage Diagonal Cutters



1000volt

328 High Leverage Diagonal Cutters. Insulation According to VDE 0682/part 201, DIN EN 60900, IEC 900, ASTM F-1505-01, up to 1000 volt. "GS" Sign. Individually Tested. DIN ISO 5749 Semi-circular. Low wear lap joint, riveted and able to withstand high levels of load. Lightweight action, clean cutting. Long term cutting is achieved through additional inductive hardening to approx. 64 HRC. C 60 special tool steel hardened and tempered to high quality. For soft, hard and piano wire, lay-on joint, optimized power transmission.

| Item No. | | mm | Inch | Cutting Capacity Copper AWG | Pkg. wt. | Each |
|----------|-----------|-----|------|--------------------------------|----------|---------|
| 328 35 | Z16016006 | 160 | 6.5 | #6 | 1 .54 | \$36.98 |
| 328 36 | Z16018006 | 180 | 7.0 | #5 | 1 .57 | \$45.98 |
| 328 38 | Z16020006 | 200 | 8.0 | #4 | 1 .64 | \$48.98 |

Insulated Cable Cutter



1000volt

328 Cable Cutter. Insulation According to VDE 0682/part 201, DIN EN 60900, IEC 900, ASTM F-1505-01, up to 1000 volt. "GS" Sign. Individually Tested. Drop-forged from durable CV steel, cutters additionally induction hardened, chrome & nickel plated, Mirror-polished. For copper and aluminum cables (not for steel wires), integrated release spring, one-hand locking, adjustable joint, anti-squeeze feature.

| Item No. | | mm | Inch | Min mm | Max mm | Pkg. wt. | Each |
|----------|-----------|-----|------|--------|--------|----------|---------|
| 328 46 | Z50023006 | 230 | 9.0 | 17 | 40 | 1 .98 | \$59.98 |
| 328 48 | Z50017006 | 170 | 6.75 | 10 | 60 | 1 .67 | \$49.98 |





Made in Germany

www.wihatools.com

Click image to view web page

Wiha Insulated Pliers & Cutters

Insulated Long Nose Pliers

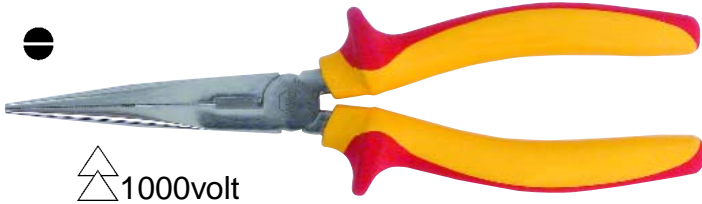

328 Long Nose Pliers With Cutter. Insulation According to VDE 0682/part 201, DIN EN 60900, IEC 900, ASTM F-1505-01, up to 1000 volt. "GS" Sign. Individually Tested. Drop-forged from special tool steel, cutters additionally induction hardened (approx. 60 HRC), chrome-nickel plated, mirror-polished, ergonomic comfort grip with slip guard, half-round jaws, serrated gripping surface.

| Item No. | | ↔ mm | ↔ Inch | Cutting Capacity Copper AWG | 🔌 Pkg. | 🔌 wt. | 🔌 Each |
|----------|-----------|------|--------|--------------------------------|--------|-------|---------|
| 328 06 | Z05016006 | 160 | 6.5 | #10 | 1 | .32 | \$31.98 |
| 328 08 | Z05020006 | 200 | 8.0 | #8 | 1 | .42 | \$34.98 |

Insulated Bent Nose Pliers

Angled approx. 40°

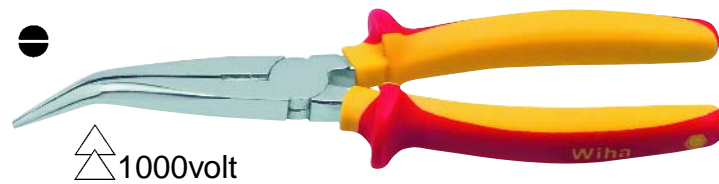

328 Bent Nose Pliers With Cutter. Insulation According to VDE 0682/part 201, DIN EN 60900, IEC 900, ASTM F-1505-01, up to 1000 volt. "GS" Sign. Individually Tested.

Drop-forged from special tool steel, cutters additionally induction hardened (approx. 60 HRC), chrome-nickel plated, mirror-polished. Ergonomic comfort grip with slip guard. Half-round jaws, serrated gripping surface, nose bent 45°.

| Item No. | | ↔ mm | ↔ Inch | Cutting Capacity Copper AWG | 🔌 Pkg. | 🔌 wt. | 🔌 Each |
|----------|-----------|------|--------|--------------------------------|--------|-------|---------|
| 328 04 | Z05120006 | 200 | 8.0 | #8 | 1 | .43 | \$39.98 |
| 328 07 | Z05116006 | 160 | 6.5 | #10 | 1 | .32 | \$32.98 |

1000 Volt Rated

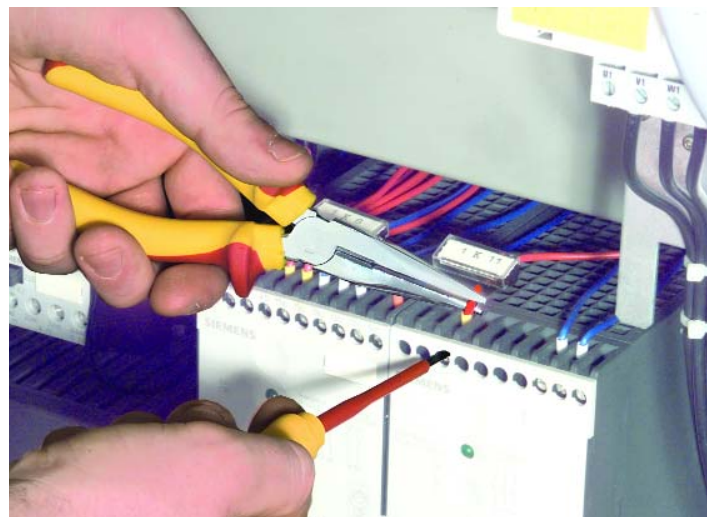

Warning! Insulated tools are not intended for use on live or energized circuits. Always disconnect and de-energize all equipment & circuits. **NEVER!** work on live or energized circuits or equipment.

Use & Care Guide For Insulated Tools:

- Store tools to minimize risk of damage to insulation
- Inspect insulation prior to each use of any insulated tool
- If you doubt the integrity of the insulation destroy the tool or have it retested
- Use insulated tools where the ambient temperature is between -20 to +70° C
- Have a qualified safety technician inspect and re-certify tools annually for safe use



Made in Germany

Toll Free: (800) 494-6104

Click image to view web page

Wiha Insulated Pliers & Cutters

Round Nose Pliers

1000volt



328 Round Nose Pliers. Insulation According to VDE 0682/part 201, DIN EN 60900, IEC 900, ASTM F-1505-01, up to 1000 volt. "GS" Sign. Individually Tested. Drop-forged from special tool steel, individually induction hardened, chrome and nickel plated, mirror-polished. Ergonomic comfort grip with slip guard. Serrated jaws.

| Item | | | | | |
|--------|-----------|------|------|-----|-------------|
| No. | mm | Inch | Pkg. | wt. | Each |
| 328 70 | Z09016006 | 160 | 6.5 | 1 | .31 \$30.98 |

Insulated Long Flat Nose Pliers

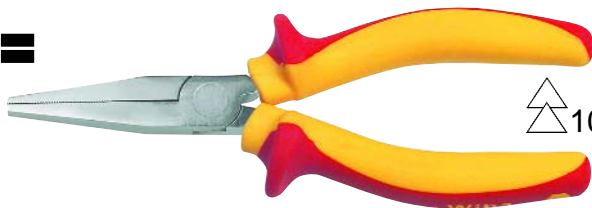

1000volt

328 Long Flat Nose Pliers. Insulation According to VDE 0682/part 201, DIN EN 60900, IEC 900, ASTM F-1505-01, up to 1000 volt. "GS" Sign. Individually Tested. DIN ISO 5745 Extra long head. Serrated Jaws are induction hardened. Special CV tool steel forgings, Chrome finish. Two component Soft Grip handles. Use for Gripping and right-angle bending of wires and sheet metal parts.

| Item | | | | | |
|--------|-----------|------|------|-----|-------------|
| No. | mm | Inch | Pkg. | wt. | Each |
| 328 10 | Z07016006 | 160 | 6.5 | 1 | .39 \$29.98 |

Insulated Stripping Pliers

1000volt



328 Stripping Pliers. Insulation According to VDE 0682/part 201, DIN EN 60900, IEC 900, ASTM F-1505-01, up to 1000 volt. "GS" Sign. Individually Tested. Drop-forged from special tool steel, individually high frequency induction hardened, chrome and nickel plated, mirror-polished. Ergonomic comfort grip with slip guard. Spring and adjusting screw, for wires up to Ø 5mm

| Item | | | Stripping Capacity | | | |
|--------|-----------|------|--------------------|------|-------------|------|
| No. | mm | Inch | Copper AWG | Pkg. | wt. | Each |
| 328 60 | Z55016006 | 160 | 6.5 #4 - #28 | 1 | .36 \$38.98 | |



Warning!
Insulated tools are not intended for use on live or energized circuits. Always disconnect and de-energize all equipment & circuits. **NEVER!** work on live or energized circuits or equipment.



Made in Germany

www.wihatools.com

Click image to view web page

Wiha ComfortGrip Pliers & Cutters

Maximum comfort in daily use, smooth operation & optimum force transmission without uncomfortable pressure points. A multi-layered chrome finish provides the highest level of corrosion protection.

NEW
from Wiha

Hard Chrome finish for long lasting corrosion protection.



Ergonomic shape for maximum user comfort

Cutters additionally induction hardened

Soft rounded slip guard molded into grip

Anti-slip soft dual material Handles for safe gripping

ComfortGrip Combination Pliers



329 10 Combination Pliers DIN ISO 5746

Extra long cutting edge for flat and round cables. Serrated jaws. Cutting edges additionally induction hardened to approx. 60HRC. Special CV tool steel. For gripping and holding as well as cutting soft and hard wires and cables. Two component ComfortGrip ergonomic handles

| Item | ↔ | ↔ | Cutting Capacity | | ☐ | ↕ |
|------------------|-----|------|------------------|----------|------|---------|
| No. | mm | Inch | Copper AWG | Pkg. wt. | Each | |
| 329 10 Z01020005 | 200 | 8.0 | #8 | 1 | .72 | \$25.98 |

ComfortGrip Heavy Duty Combination Pliers



329 16 Heavy Duty Combination Pliers DIN ISO 5746

Larger Head and extra long cutting edges for flat and round cables. Serrated jaws with lower fish tape pulling jaw. Cutting edges additionally induction hardened to approx. 64HRC. Special CV tool steel. For gripping & holding as well as cutting wires & cables ranging in hardness from soft to extremely hard. Two component ComfortGrip ergo handles.

| Item | ↔ | ↔ | Cutting Capacity | | ☐ | ↕ |
|------------------|-----|------|------------------|----------|------|---------|
| No. | mm | Inch | Copper AWG | Pkg. wt. | Each | |
| 329 16 Z02022505 | 225 | 9.0 | #5 | 1 | .79 | \$33.98 |

ComfortGrip Stripping Pliers



329 46 Stripping Pliers DIN ISO 5744

Precision cutting edge formed for even cutting of cable insulation. Easy to use adjustment screw allows stripping diameter to be quickly changed. Return spring for effortless use. Special CV tool steel edges, individually induction hardened. Stripping Diameter: .019" to .393" Ø.5mm - 10mm.

| Item | ↔ | ↔ | Stripping Capacity | | ☐ | ↕ |
|------------------|-----|------|--------------------|----------|------|---------|
| No. | mm | Inch | Copper AWG | Pkg. wt. | Each | |
| 329 46 Z55016005 | 160 | 6.5 | #4 - #28 | 1 | .31 | \$27.98 |



Made in Germany

Toll Free: (800) 494-6104

Click image to view web page

Wiha ComfortGrip Pliers

ComfortGrip Long Nose Pliers



329 Long Nose Pliers With Cutting Edge DIN ISO 5745
 Long nose pliers. Extra long cutters for flat and round wires. Gripping surfaces serrated in parts. Cutting edges additionally induction hardened to approx. 60 HRC. Special tool steel. Two component ComfortGrip handle.

| Item No. | mm | Inch | Cutting Capacity Copper AWG | Pkg. | wt. | Each |
|------------------|-----|------|--------------------------------|------|-----|---------|
| 329 19 Z05016005 | 160 | 6.5 | #8 | 1 | .32 | \$22.98 |
| 329 22 Z05020005 | 200 | 8.0 | #8 | 1 | .42 | \$29.98 |

ComfortGrip Bent Long Nose Pliers

Angled approx. 40°



329 24 Bent Nose Pliers With Cutters DIN ISO 5745
 Long nose pliers angled approx. 40°. Extra long cutting edge for flat and round wires. Gripping surfaces serrated in parts. Cutting edges additionally induction hardened to approx. 60 HRC. Special tool steel. Two component ComfortGrip handle.

| Item No. | mm | Inch | Cutting Capacity Copper AWG | Pkg. | wt. | Each |
|------------------|-----|------|--------------------------------|------|-----|---------|
| 329 24 Z05116005 | 160 | 6.5 | #8 | 1 | .32 | \$27.98 |

ComfortGrip Flat Nose Pliers



329 31 Long Flat Nose Pliers DIN ISO 5745
 Extra long head. Gripping surfaces serrated and induction hardened. Special tool steel. Two component ComfortGrip handle. Gripping and right-angled bending of wires and sheet metal parts.

| Item No. | mm | Inch | Pkg. | wt. | Each |
|------------------|-----|------|------|-----|---------|
| 329 31 Z07016005 | 160 | 6.5 | 1 | .32 | \$25.98 |

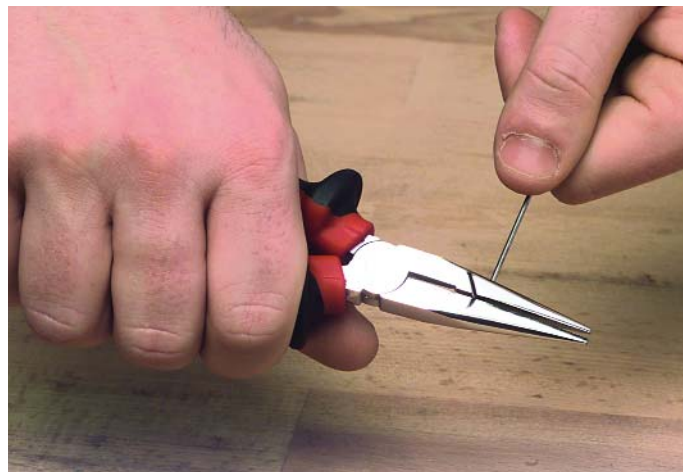



Made in Germany

Toll Free: (800) 494-6104

Click image to view web page

Wiha Professional ComfortGrip Pliers/Cutters

ComfortGrip Diagonal Cutters



329 Diagonal Cutters DIN ISO 5749

Low wear lap joint, riveted and able to withstand high levels of load. Low force action, clean cutting. Long life cutting edge is achieved with additional induction hardening to approx. 60 HRC. Special CV tool steel forgings hardened and tempered. For soft & medium hard wire.

| Item No. | | ↔ | ↔ | Cutting Capacity Copper AWG | Pkg. | wt. | Each |
|----------|-----------|-----|------|--------------------------------|------|-----|---------|
| | | mm | Inch | | | | |
| 329 36 | Z12014005 | 140 | 5.5 | #6 | 1 | .39 | \$25.98 |
| 329 40 | Z12016005 | 160 | 6.5 | #6 | 1 | .48 | \$26.98 |
| 329 43 | Z12018005 | 180 | 7.0 | #6 | 1 | .62 | \$28.98 |

ComfortGrip High Leverage Diagonal Cutters



329 High Leverage Diagonal Cutters DIN ISO 5749

Semi-circular. Low wear lap joint, riveted and able to withstand high levels of load. Low force action, clean cutting. Long life cutting edges are achieved through additional induction hardening to approx. 64 HRC. C60 special CV tool steel hardened and tempered.

| Item No. | | ↔ | ↔ | Cutting Capacity Copper AWG | Pkg. | wt. | Each |
|----------|-----------|-----|------|--------------------------------|------|-----|---------|
| | | mm | Inch | | | | |
| 329 50 | Z16018005 | 180 | 7.0 | #5 | 1 | .57 | \$35.98 |
| 329 53 | Z16020005 | 200 | 8.0 | #4 | 1 | .64 | \$37.98 |



329 90 4 Pc. Comfort Grip Plier Set In Zipper Case

Low wear lap joint, riveted and able to withstand high levels of load. Low force action, clean cutting. Long life cutting edge is achieved with additional induction hardening to approx. 60 HRC. Special CV tool steel forgings hardened and tempered.

| Item# | 32990 Set Includes: | Each |
|-------|-------------------------|----------|
| 32910 | Combo Pliers - 8" | \$126.98 |
| 32946 | Wire Stripper - 6.5" | |
| 32919 | Long Nose Pliers - 6.5" | \$126.98 |
| 32940 | Side Cutter - 6.5" | |



329 91 18 Pc. Comfort Grip Plier/Driver/Wrench Set In Zipper Case

Low force action, clean cutting. Special CV tool steel forgings hardened and tempered. SoftFinish cushion grip screwdriver handle, allows maximum torque and user comfort. Open End wrenches precision formed for exact fit. Satin chromed sure grip body.

| Item# | 32991 Set Includes: | Each |
|-------|-------------------------|----------|
| 32910 | Combo Pliers - 8" | \$229.98 |
| 32940 | Side Cutter - 6.5" | |
| 32919 | Long Nose Pliers - 6.5" | \$229.98 |
| 32962 | Adjustable Pliers - 10" | |
| 36276 | SoftFinish Torx T15 | \$229.98 |
| 30215 | SoftFinish Slotted 4.0 | |
| 36278 | SoftFinish Torx T20 | \$229.98 |
| 30223 | SoftFinish Slotted 6.5 | |
| 36280 | SoftFinish Torx T25 | \$229.98 |
| 31110 | SoftFinish Phillips #1 | |
| 36282 | SoftFinish Torx T27 | \$229.98 |
| 31115 | SoftFinish Phillips #2 | |
| 36284 | SoftFinish Torx T30 | \$229.98 |
| 35032 | Open End 1/4" x 5/16" | |
| 35034 | Open End 3/8" x 7/16" | \$229.98 |
| 35039 | Open End 5/8" x 11/16" | |
| 35036 | Open End 1/2" x 9/16" | \$229.98 |
| 35043 | Open End 7/8" x 3/4" | |



Made in Germany

www.wihatools.com

Click image to view web page

Wiha Vinyl Grip Pliers & Cutters

Wiha Pliers & Cutters, Professional quality at competitive prices. A wide selection covering most applications in which pliers & cutters are required.

NEW
from Wiha

Precision formed

Jaws & Cutters
induction
hardened

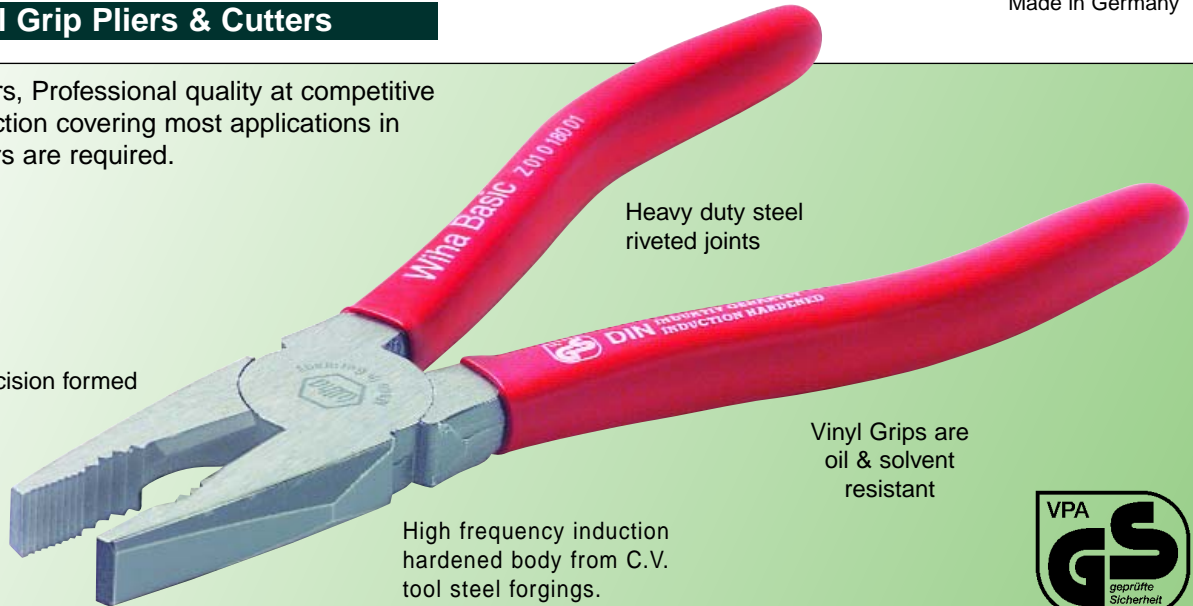

Heavy duty steel
riveted joints

High frequency induction
hardened body from C.V.
tool steel forgings.

Vinyl Grips are
oil & solvent
resistant



Combination Pliers



326 Combination Pliers DIN ISO 5746

Extra long cutting edge for flat and round cables. Serrated jaws. Cutting edges additionally induction hardened to approx. 60HRC. C.V. Special tool steel. For gripping and holding as well as cutting soft and hard wires and cables. Soft vinyl grips, oil & solvent resistant.

| Item No. | | ↔ | ↔ | Cutting Capacity | ↔ | ↔ |
|----------|-----------|-----|------|------------------|----------|---------|
| | | mm | Inch | Copper AWG | Pkg. wt. | Each |
| 326 03 | Z01016001 | 160 | 6.5 | #10 | 1 .41 | \$15.98 |
| 326 06 | Z01018001 | 180 | 7.0 | #9 | 1 .50 | \$16.98 |
| 326 09 | Z01020001 | 200 | 8.0 | #8 | 1 .63 | \$18.98 |

High Leverage Combination Pliers



With Lower Serrated Pulling Jaws

326 High Leverage Heavy Duty Combination Pliers DIN ISO 5746

Extra long cutting edge for flat and round cables. Serrated upper jaws and lower pulling jaws. Cutting edges additionally induction hardened to approx. 60HRC. C.V. Special tool steel forgings. Use For gripping, pulling & holding as well as cutting soft, hard & piano wires and cables. Soft vinyl grips are oil & solvent resistant.

| Item No. | | ↔ | ↔ | Cutting Capacity | ↔ | ↔ |
|----------|-----------|-----|------|------------------|----------|---------|
| | | mm | Inch | Copper AWG | Pkg. wt. | Each |
| 326 12 | Z02020001 | 200 | 8.0 | #4 | 1 .61 | \$21.98 |
| 326 15 | Z02022501 | 225 | 9.0 | #4 | 1 .78 | \$24.98 |

Stripping Pliers



326 45 Stripping Pliers DIN ISO 5744

Precision cutting edge prism for even cutting of cable insulation. Easy to use adjusting screw allows the stripping diameter to be set. Opening spring for effortless and sensitive handling of pliers. C.V. special tool steel, individually induction hardened. Stripping of cables and strands up to Ø 5mm = 10mm² conductor cross-section. Soft vinyl grips.

| Item No. | | ↔ | ↔ | Stripping Capacity | ↔ | ↔ |
|----------|-----------|-----|------|--------------------|----------|---------|
| | | mm | Inch | Copper Awg# | Pkg. wt. | Each |
| 326 45 | Z55016001 | 160 | 6.5 | #4 - #28 | 1 .31 | \$21.98 |



Made in Germany

Toll Free: (800) 494-6104

Click image to view web page

Wiha Vinyl Grip Pliers & Cutters

Long Nose Pliers



326 Long Nose Pliers With Cutters DIN ISO 5745

Long nose pliers. Extra long cutters for flat and round cables. Serrated Jaws. Cutting edges additionally induction hardened to approx. 60 HRC. Special CV tool steel forgings. Soft vinyl grips are oil & solvent resistant.

| Item No. | mm | Inch | Cutting Capacity Copper AWG | Pkg. wt. | Each |
|------------------|-----|------|--------------------------------|----------|---------|
| 326 18 Z05016001 | 160 | 6.5 | #10 | 1 .28 | \$18.98 |
| 326 21 Z05020001 | 200 | 8.0 | #8 | 1 .36 | \$24.98 |

Bent Long Nose Pliers

Angled approx. 40°



326 Bent Long Nose Pliers With Cutters DIN ISO 5745

Long nose pliers angled approx. 40°. Extra long cutters for flat and round wire. Partially Serrated Jaws. Cutting edges additionally induction hardened to approx. 60 HRC. Special CV tool steel forgings. Soft vinyl grips are oil & solvent resistant.

| Item No. | mm | Inch | Cutting Capacity Copper AWG | Pkg. wt. | Each |
|------------------|-----|------|--------------------------------|----------|---------|
| 326 23 Z05116001 | 160 | 6.5 | #10 | 1 .28 | \$21.98 |
| 326 25 Z05120001 | 200 | 8.0 | #8 | 1 .36 | \$27.98 |

Long Flat Nose Pliers



326 30 Long Flat Nose Pliers DIN ISO 5745

Extra long head. Serrated Jaws are induction hardened. Special CV tool steel forgings. Use for gripping and right-angled bending of wires and sheet metal parts. Soft vinyl grips are oil & solvent resistant.

| Item No. | mm | Inch | Pkg. wt. | Each |
|------------------|-----|------|----------|---------|
| 326 30 Z07016001 | 160 | 6.5 | 1 .26 | \$19.98 |

Long Round Nose Pliers



326 33 Long Round Nose Pliers DIN ISO 5745

Extra long head. Serrated Jaws are induction hardened. Special CV tool steel forgings. Use for gripping and uniform round bending of wires and sheet metal parts. Soft vinyl grips are oil & solvent resistant.

| Item No. | mm | Inch | Pkg. wt. | Each |
|------------------|-----|------|----------|---------|
| 326 33 Z09016001 | 160 | 6.5 | 1 .25 | \$18.98 |





Made in Germany

www.wihatools.com

Click image to view web page

Wiha Vinyl Grip Pliers & Cutters

Standard Adjustable Pliers



326 Adjustable Pliers - Box Type DIN ISO 5745

10 different opening sizes provide optimal adjustment to objects being gripped. Long durability achieved through additional induction hardening of jaws to approx. 58-60 HRC. Chrome-vanadium tool steel, hardened and tempered. Soft vinyl grips are oil and solvent resistant.

| Item No. | Part No. | mm | Inch | Capacities | | Pkg. | wt. | Each |
|----------|-----------|-----|------|------------|-------|------|------|---------|
| | | | | Round | Hex | | | |
| 326 60 | Z21018001 | 180 | 7.0 | 1.25 | 1 1/2 | 1 | .35 | \$21.98 |
| 326 61 | Z21025001 | 250 | 10.0 | 1.75 | 2" | 1 | .67 | \$22.98 |
| 326 63 | Z21030001 | 300 | 12.0 | 2.0 | 2 1/4 | 1 | 1.21 | \$33.98 |

Slide Lock Adjustable Pliers - "QuickFix"



- Open and slide to adjust opening size
- Close to lock
- Audible click at each locking position

326 68 Slide Lock Adjustable Pliers - Wiha QuickFix - Box Type

DIN ISO 8976 Super fast and easily adjusted pliers. Long durability achieved through additional induction hardening of jaws to approx. 56 HRC. Finger jam protection for safe operation in all settings. Chrome-vanadium tool steel, hardened and tempered. Soft vinyl grips.

| Item No. | Part No. | mm | Inch | Capacities | | Pkg. | wt. | Each |
|----------|-----------|-----|------|------------|-------|------|-----|---------|
| | | | | Round | Hex | | | |
| 326 68 | Z23025001 | 250 | 10.0 | 1 1/4 | 1 1/2 | 1 | .72 | \$31.98 |



326 01 4 Pc. Pliers & Cutters Set

Drop-forged from special tool steel, individually high frequency induction hardened. Precision formed. Soft vinyl grips, oil & solvent resistant. In zipper carry case.

| | | | |
|-------------|----------------------|----------|---------------------|
| Item# 32601 | Set Includes: | wt. 3.45 | Each \$99.98 |
| 32609 | - Combination Pliers | 32661 | - Water Pump Pliers |
| 32618 | - Long Nose Pliers | 32642 | - Diagonal Cutters |



326 98 3 Pc. Pliers & Cutters Set

Drop-forged from special tool steel, individually high frequency induction hardened. Precision formed. Soft vinyl grips, oil & solvent resistant.

| | | | |
|-------------|----------------------|----------|--------------------|
| Item# 32698 | Set Includes: | wt. 1.36 | Each \$55.48 |
| 32606 | - Combination Pliers | 32642 | - Diagonal Cutters |
| 32618 | - Long Nose Pliers | | |



Made in Germany

Toll Free: (800) 494-6104

Click image to view web page

Wiha Vinyl Grip Pliers & Cutters

High Leverage Cable Cutters



326 High Leverage Cable Cutters

Sickle-shaped cutting edge to prevent cable movement when cutting. Fastened adjustable lay-on joint. Clean cutting edges for cutting soft cable. Safety lock with opening spring. Special CV tool steel forging, hardened and tempered for maximum performance. Soft vinyl grips are oil & solvent resistant.

| Item | | ↔ | ↔ | Min. | Max. | 🔒 | 🔓 | |
|-------|-----------|-----|------|------|------|------|-----|---------|
| No. | | mm | Inch | mm | mm | Pkg. | wt. | Each |
| 32641 | Z50017001 | 170 | 6.75 | 12 | 40 | 1 | .62 | \$30.98 |
| 32643 | Z50023001 | 230 | 9 | 18 | 60 | 1 | .94 | \$49.98 |

Diagonal Cutters



326 Diagonal Cutters DIN ISO 5749

Low wear lap joint, riveted and able to withstand high levels of load. Low force cutting action, clean cutting. Long life edge is achieved through additional induction hardening to approx. 60 HRC. Special CV tool steel hardened and tempered. For soft & medium hard wire. Soft vinyl grips.

| Item | | ↔ | ↔ | Cutting Capacity | 🔒 | 🔓 | |
|--------|-----------|-----|------|------------------|------|-----|---------|
| No. | | mm | Inch | Copper AWG | Pkg. | wt. | Each |
| 326 38 | Z12014001 | 140 | 5.5 | #6 | 1 | .33 | \$18.98 |
| 326 42 | Z12016001 | 160 | 6.5 | #6 | 1 | .42 | \$19.98 |
| 326 39 | Z12018001 | 180 | 7.0 | #6 | 1 | .53 | \$21.98 |

High Leverage Cutters



326 High Leverage Cutters DIN ISO 5749

Semi-circular. Low wear lap joint, riveted and able to withstand high levels of load. Low force action, clean cutting. Long life is achieved through additional induction hardening of cutting edge to 64 HRC.

CV 60 special tool steel hardened and tempered. Soft vinyl grips

| Item | | ↔ | ↔ | Cutting Capacity | 🔒 | 🔓 | |
|--------|-----------|-----|------|------------------|------|-----|---------|
| No. | | mm | Inch | Copper AWG | Pkg. | wt. | Each |
| 326 46 | Z16016001 | 160 | 6.5 | #6 | 1 | .42 | \$23.98 |
| 326 49 | Z16018001 | 180 | 7.0 | #5 | 1 | .50 | \$25.98 |
| 326 52 | Z16020001 | 200 | 8.0 | #4 | 1 | .55 | \$28.98 |

High Leverage End Cutting Pliers



326 High Leverage End Cutting Pliers DIN ISO 5749 Low wear lap joint, riveted and able to withstand high levels of load. Low force action, clean cutting. Long life cutting edges are achieved through additional induction hardening to approx. 60 HRC. Special CV tool steel forgings hardened and tempered. Soft vinyl grips are oil & solvent resistant.

| Item | | ↔ | ↔ | Cutting Capacity | 🔒 | 🔓 | |
|--------|-----------|-----|------|------------------|------|-----|---------|
| No. | | mm | Inch | Copper AWG | Pkg. | wt. | Each |
| 326 57 | Z17016001 | 160 | 6.5 | #6 | 1 | .41 | \$16.98 |
| 326 58 | Z17018001 | 180 | 7.0 | #5 | 1 | .61 | \$18.98 |
| 326 59 | Z17020001 | 200 | 8.0 | #4 | 1 | .75 | \$22.98 |



Made in Germany

Wiha Vinyl Grip Pliers & Cutters

Carpenter's End Nippers



326 Carpenter's End Nippers DIN ISO 9243

High cutting performance and reduced effort achieved through the precise formation of the cutting blade after assembly. Long life cutting edges achieved by additional induction hardening. Special CV tool steel, hardened and tempered. Soft vinyl grips are oil & solvent resistant.

| Item | | ↔ | ↔ | | | |
|--------|-----------|-----|------|------|-----|---------|
| No. | | mm | Inch | Pkg. | wt. | Each |
| 326 71 | Z30018001 | 180 | 7.0 | 1 | .62 | \$15.98 |
| 326 72 | Z30020001 | 200 | 8.0 | 1 | .86 | \$16.98 |

Mason Nippers



326 Mason Nippers DIN ISO 9243

High cutting performance and reduced effort achieved through the precise formation of the cutting blade after assembly. Long life induction hardened cutting edges. Special tool steel, hardened and tempered. Soft vinyl Grips are oil & solvent resistant.

| Item | | ↔ | ↔ | Cutting Capacity | | |
|--------|-----------|-----|------|------------------|------|--------------|
| No. | | mm | Inch | Hard Wire AWG | Pkg. | wt. Each |
| 326 74 | Z31022001 | 220 | 8.75 | #12 | 1 | .76 \$17.98 |
| 326 76 | Z31025001 | 250 | 10.0 | #12 | 1 | .98 \$19.98 |
| 326 78 | Z31028001 | 280 | 11.0 | #12 | 1 | 1.00 \$21.98 |
| 326 80 | Z31030001 | 300 | 12.0 | #12 | 1 | 1.06 \$24.98 |



Made in Germany

Toll Free: (800) 494-6104

Click image to view web page

Wiha Forged Retaining Ring Pliers

Retaining Ring Pliers - Internal



326 Straight Internal Retaining Ring Pliers DIN ISO 5256 - 4 Pc Set 32626
Shape C, straight tips. Die forged cylindrical precision formed. Chrome-vanadium special tool steel. For inserting & removing internal retaining rings.

| Item | ↔ | ↔ | ⊖ | ⊖ | ● Tip | ☐ | ↶ | ↷ | |
|--------|-----------|------|------|-----------|---------|----------|-----|------|---------|
| No. | mm | Inch | Inch | mm | Inch/mm | Pkg. | wt. | Each | |
| 326 81 | Z330J0001 | 140 | 5.5 | 5/16-1/2 | 8-13 | .035/.9 | 1 | .19 | \$15.98 |
| 326 82 | Z330J1001 | 140 | 5.5 | 1/2-1 | 12-25 | .050/1.3 | 1 | .19 | \$15.98 |
| 326 83 | Z330J2001 | 170 | 6.7 | 3/4-2 3/8 | 19-60 | .070/1.5 | 1 | .42 | \$16.98 |
| 326 84 | Z330J3001 | 220 | 8.6 | 1 1/2-4 | 40-100 | .090/2.3 | 1 | .53 | \$17.98 |

90° Angle Retaining Ring Pliers - Internal



326 90° Angle Internal Retaining Ring Pliers DIN ISO 5254 - 4 Pc Set 32627
Shape D, 90° angled tips. Die forged cylindrical precision formed. CV Special tool steel. For inserting & removing internal retaining rings. Soft vinyl grips.

| Item | ↔ | ↔ | ⊖ | ⊖ | ● Tip | ☐ | ↶ | ↷ | |
|--------|-----------|------|------|-----------|---------|----------|-----|------|---------|
| No. | mm | Inch | Inch | mm | Inch/mm | Pkg. | wt. | Each | |
| 326 85 | Z331J0101 | 125 | 4.9 | 5/16-1/2 | 8-13 | .035/.9 | 1 | .19 | \$17.98 |
| 326 86 | Z331J1101 | 125 | 4.9 | 1/2-1 | 12-25 | .050/1.3 | 1 | .19 | \$17.98 |
| 326 87 | Z331J2101 | 165 | 6.5 | 3/4-2 3/8 | 19-60 | .070/1.5 | 1 | .42 | \$17.98 |
| 326 88 | Z331J3101 | 210 | 8.2 | 1 1/2-4 | 40-100 | .090/2.3 | 1 | .53 | \$18.98 |

Retaining Ring Pliers - External



326 Straight External Retaining Ring Pliers DIN ISO 5254 - 4 Pc Set 32628
Shape A, straight tips. Die forged cylindrical precision formed. CV special tool steel. For fitting & removing external retaining rings. Soft vinyl grips.

| Item | ↔ | ↔ | ⊖ | ⊖ | ● Tip | ☐ | ↶ | ↷ | |
|--------|-----------|------|------|-----------|---------|----------|-----|------|---------|
| No. | mm | Inch | Inch | mm | Inch/mm | Pkg. | wt. | Each | |
| 326 89 | Z340A0001 | 140 | 5.5 | 1/8-3/8 | 3-10 | .035/.9 | 1 | .19 | \$17.98 |
| 326 90 | Z340A1001 | 140 | 5.5 | 3/8-1 | 10-25 | .050/1.3 | 1 | .19 | \$17.98 |
| 326 91 | Z340A2001 | 170 | 6.7 | 3/4-2 3/8 | 19-60 | .070/1.5 | 1 | .42 | \$17.98 |
| 326 92 | Z340A3001 | 220 | 8.6 | 1 1/2-4 | 40-100 | .090/2.3 | 1 | .53 | \$19.98 |

90° Angle Retaining Ring Pliers - External

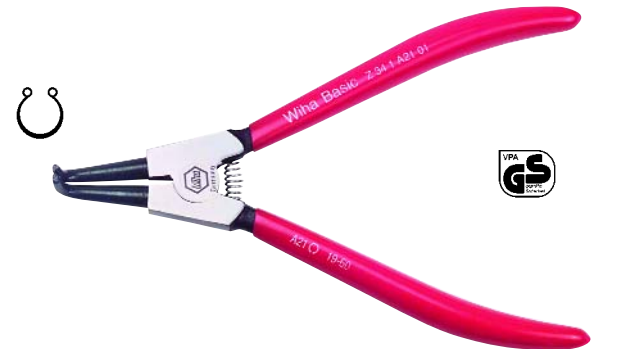

326 90° Angled External Retaining Ring Pliers DIN ISO 5254 - 4 Pc Set 32629
Shape B, 90° angled tips. Die forged cylindrical precision formed. CV special tool steel. For fitting & removing external retaining rings. Soft vinyl grips.

| Item | ↔ | ↔ | ⊖ | ⊖ | ● Tip | ☐ | ↶ | ↷ | |
|--------|-----------|------|------|-----------|---------|----------|-----|------|---------|
| No. | mm | Inch | Inch | mm | Inch/mm | Pkg. | wt. | Each | |
| 326 94 | Z341A0101 | 125 | 4.9 | 1/8-3/8 | 8-13 | .035/.9 | 1 | .19 | \$18.98 |
| 326 95 | Z341A1101 | 125 | 4.9 | 3/8-1 | 12-25 | .050/1.3 | 1 | .19 | \$18.98 |
| 326 96 | Z341A2101 | 165 | 6.5 | 3/4-2 3/8 | 19-60 | .070/1.5 | 1 | .42 | \$19.98 |
| 326 97 | Z341A3101 | 210 | 8.2 | 1 1/2-4 | 40-100 | .090/2.3 | 1 | .53 | \$21.98 |



Made in Germany

Wiha Long Life Maxiflex Folding Rulers

From KWB division of Wiha in Switzerland



Patented play free joint with steel spring pin, wear resistant & maintenance free

90° positive stop joints

Reinforced with 30% fiberglass, rugged polyimide is scratch resistant

Deep embossed water proof scales

Tough and Flexible, impact resistant

Chemical and weather resistant for outdoor use

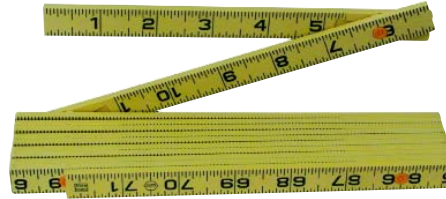

616 09 Inside Reading Long Life MaxiFlex Folding Rulers

Molded 30% fiber glass reinforced polyimide scratch, chemical & weather resistant both tough & flexible, impact resistant. Patented play free joint with steel spring is wear and maintenance free. 90° positive stop joints. Deep embossed scale on both sides of rules. Metric rules have 10cm red marking. Inch rules have 16" red stud wall marking.

| Item | | | | | | | | |
|--------|-----|-------|----------|------------|------|------|---------|--|
| No. | Ft. | Width | Sections | Increments | lbs. | pkg. | Each | |
| 616 09 | 6' | 5/8" | 12 | 1/16" | .39 | 72 | \$17.98 | |

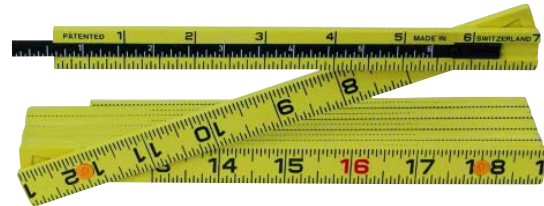

616 20 Outside Reading 6" Depth Extension Long Life MaxiFlex Folding Rulers

Molded 30% fiber glass reinforced polyimide scratch, chemical & weather resistant both tough & flexible, impact resistant. Patented play free joint with steel spring is wear and maintenance free. 90° positive stop joints. Deep embossed scale on both sides of rules. Metric rules have 10cm red marking. Inch rules have 16" red stud wall marking.

| Item | | | | | | | | |
|--------|-----|-------|-------|----------|------------|------|------|---------|
| No. | Ft. | Depth | Width | Sections | Increments | lbs. | pkg. | Each |
| 616 20 | 6' | 6" | 5/8" | 12 | 1/16" | .40 | 72 | \$18.98 |

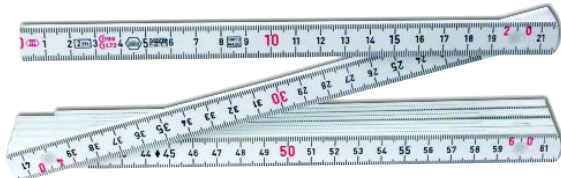

616 62 Combination Metric & Inch Long Life MaxiFlex Folding Rulers

Molded 30% fiber glass reinforced polyimide scratch, chemical & weather resistant both tough & flexible, impact resistant. Patented play free joint with steel spring is wear and maintenance free. 90° positive stop joints. Deep embossed scale on both sides of rules. Metric rules have 10cm red marking.

| Item | | | | | | | | |
|--------|-------|------|-------|----------|------------|------|------|--------|
| No. | Meter | Inch | Width | Sections | Increments | lbs. | pkg. | Each |
| 616 62 | 2 | 78" | 15mm | 10 | 1/16 & 1mm | .31 | 72 | \$9.98 |

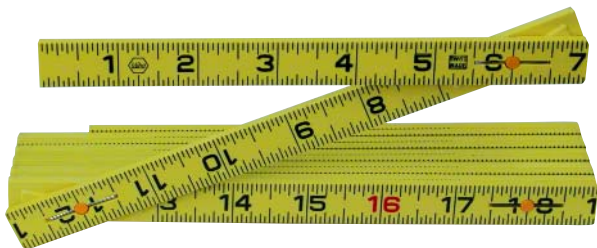

616 19 Outside Reading Long Life MaxiFlex Folding Rulers

Molded 30% fiber glass reinforced polyimide scratch, chemical & weather resistant both tough & flexible, impact resistant. Patented play free joint with steel spring is wear and maintenance free. 90° positive stop joints. Deep embossed scale on both sides of rules. Metric rules have 10cm red marking. Inch rules have 16" red stud wall marking.

| Item | | | | | | | | |
|--------|-----|-------|----------|------------|------|------|---------|--|
| No. | Ft. | Width | Sections | Increments | lbs. | pkg. | Each | |
| 616 19 | 6' | 5/8" | 12 | 1/16" | .39 | 72 | \$17.98 | |

616 02 Outside Reading Metric Long Life MaxiFlex Folding Rulers

Molded 30% fiber glass reinforced polyimide scratch, chemical & weather resistant both tough & flexible, impact resistant. Patented play free joint with steel spring is wear and maintenance free. 90° positive stop joints. Deep embossed scale on both sides of rules. Metric rules have 10cm red marking. Inch rules have 16" red stud wall marking.

| Item | | | | | | | | |
|--------|-------|-------|----------|------------|------|------|--------|--|
| No. | Meter | Width | Sections | Increments | lbs. | pkg. | Each | |
| 616 02 | 2 | 15mm | 10 | 1mm to CM | .31 | 72 | \$9.98 | |

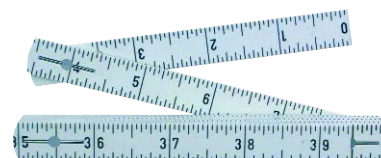

616 01 MaxiFlex Folding Rulers

| Item | | | | | | | | |
|--------|------------|-------|----------|------------|------|------|--------|--|
| No. | Inch/Meter | Width | Sections | Increments | lbs. | pkg. | Each | |
| 616 01 | 39"/1 | 1/2" | 10 | 1/16 & 1mm | .17 | 1 | \$6.98 | |



Wiha ESD Safe Pliers & Cutters

Beveled Cutter Semi-Flush Cutter

Flush Cutter Ultra Full Flush

Box joint for longer tool life & endurance, mirror polished finish

Two component handle with non-slip soft grip surface, protects the hand and reduces manual effort & user fatigue

Welded double leaf spring

Hardened & annealed high carbon tool steel, induction hardened cutting edges

Diagonal Cutters Tapered Head

Form 1 - Semi Flush

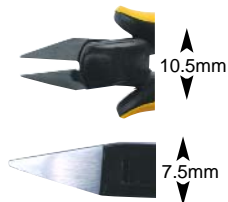

327 03 Diagonal Cutters, Small Tapered Head, Form 1- Semi Flush

Side Cutters drop-forged for an ideal material structure. Precise aligned cutting edges are additionally induction hardened at a hardness of Approx. 64°HRC. Two component non-slip soft grip handle, ESD Safe Dissipative.

| #327 03 | mm | Inch | Copper | Iron | Steel | Head Wdth | Pkg. | wt. | Each |
|---------|-----|------|--------|------|-------|-----------|------|-----|---------|
| | 115 | 4.5 | 1.0 | 0.6 | 0.3 | 10.5 | 1 | .19 | \$38.98 |

Diagonal Cutters Tapered Head

Form 2 - Flush

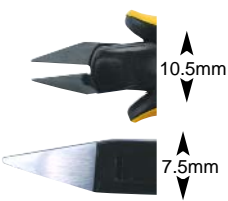

327 05 Diagonal Cutters, Small Tapered Head, Form 2 - Flush

Side Cutters drop-forged for an ideal material structure. Precise aligned cutting edges are additionally induction hardened at a hardness of Approx. 64°HRC. Two component non-slip soft grip handle, ESD Safe Dissipative.

| #327 05 | mm | Inch | Copper | Iron | Steel | Head Wdth | Pkg. | wt. | Each |
|---------|-----|------|--------|------|-------|-----------|------|-----|---------|
| | 115 | 4.5 | 1.0 | - | - | 10.5 | 1 | .19 | \$38.98 |

Diagonal Cutters Tapered Head

Form 3 - Semi Flush

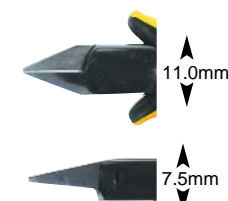

327 02 Diagonal Cutters, Small Tapered Head With Hollow Ground Back, Form 3 - Semi Flush

Side Cutters drop-forged for an ideal material structure. Precise aligned cutting edges are additionally induction hardened at a hardness of Approx. 64°HRC. Two component non-slip soft grip handle, ESD Safe Dissipative.

| #327 02 | mm | Inch | Copper | Iron | Steel | Head Wdth | Pkg. | wt. | Each |
|---------|-----|------|--------|------|-------|-----------|------|-----|---------|
| | 115 | 4.5 | 1.0 | 0.8 | - | 11.0 | 1 | .19 | \$39.98 |

Diagonal Cutters Tapered Head

Form 4 - Flush

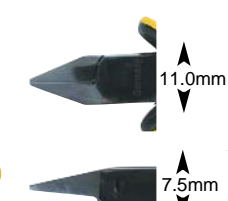

327 04 Diagonal Cutters, Small Tapered Head With Hollow Ground Back, Form 4 - Flush

Side Cutters drop-forged for an ideal material structure. Precise aligned cutting edges are additionally induction hardened at a hardness of Approx. 64°HRC. Two component non-slip soft grip handle, ESD Safe Dissipative.

| #327 04 | mm | Inch | Copper | Iron | Steel | Head Wdth | Pkg. | wt. | Each |
|---------|-----|------|--------|------|-------|-----------|------|-----|---------|
| | 115 | 4.5 | 1.0 | - | - | 11.0 | 1 | .19 | \$39.98 |



Made in Germany

Toll Free: (800) 494-6104

Click image to view web page

Wiha ESD Safe Pliers & Cutters

Diagonal Cutters Wide Tapered Head

Form 1 - Bevel

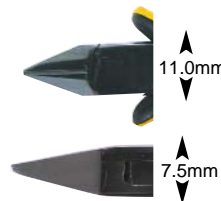

327 06 Diagonal Cutters, Wide Tapered Head, Form 1- Bevel

Side Cutters drop-forged for an ideal material structure. Precise aligned cutting edges are additionally induction hardened at a hardness of Approx. 64°HRC. Two component non-slip soft grip handle, ESD Safe Dissipative.

| #327 06 | mm | Inch | Copper | Iron | Steel | Head Wdth | Pkg. | wt. | Each |
|---------|-----|------|--------|------|-------|-----------|------|-----|---------|
| | 115 | 4.5 | 1.4 | 1.0 | 0.4 | 11.0 | 1 | .19 | \$38.48 |

Diagonal Cutters Wide Tapered Head

Form 2 - Flush

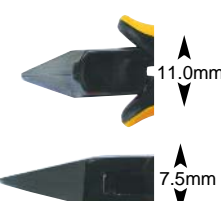

327 08 Diagonal Cutters, Wide Tapered Head, Form 2 - Flush

Side Cutters drop-forged for an ideal material structure. Precise aligned cutting edges are additionally induction hardened at a hardness of Approx. 64°HRC. Two component non-slip soft grip handle, ESD Safe Dissipative.

| #327 08 | mm | Inch | Copper | Iron | Steel | Head Wdth | Pkg. | wt. | Each |
|---------|-----|------|--------|------|-------|-----------|------|-----|---------|
| | 115 | 4.5 | 1.2 | - | - | 11.0 | 1 | .19 | \$38.48 |

Diagonal Cutters Wide Tapered Head

Form 3 - Full Flush

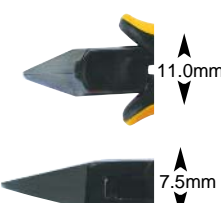

327 10 Diagonal Cutters, Wide Tapered Head, Form 3 - Full Flush

Side Cutters drop-forged for an ideal material structure. Precise aligned cutting edges are additionally induction hardened at a hardness of Approx. 64°HRC. Two component non-slip soft grip handle, ESD Safe Dissipative.

| #327 10 | mm | Inch | Copper | Iron | Steel | Head Wdth | Pkg. | wt. | Each |
|---------|-----|------|--------|------|-------|-----------|------|-----|---------|
| | 115 | 4.5 | 1.0 | - | - | 11.0 | 1 | .19 | \$42.98 |

Diagonal Cutters Wide Tapered Head

Form 4 - Flush

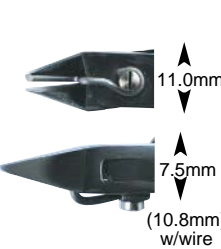

327 11 Diagonal Cutters, Wide Tapered Head With Wire Trapping Device, Form 4 - Flush

Side Cutters drop-forged for an ideal material structure. Precise aligned cutting edges are additionally induction hardened at a hardness of Approx. 64°HRC. Two component non-slip soft grip handle, ESD Safe Dissipative.

| #327 11 | mm | Inch | Copper | Iron | Steel | Head Wdth | Pkg. | wt. | Each |
|---------|-----|------|--------|------|-------|-----------|------|-----|---------|
| | 115 | 4.5 | 1.2 | - | - | 11.0 | 1 | .19 | \$40.98 |

Diagonal Cutters Slim Oval Form

Form 1 - Flush

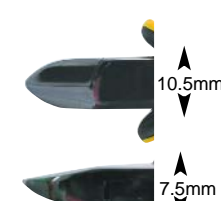

327 12 Diagonal Cutters, Slim Oval Head, Form 1 - Flush

Side Cutters drop-forged for an ideal material structure. Precise aligned cutting edges are additionally induction hardened at a hardness of Approx. 64°HRC. Two component non-slip soft grip handle, ESD Safe Dissipative.

| #327 12 | mm | Inch | Copper | Iron | Steel | Head Wdth | Pkg. | wt. | Each |
|---------|-----|------|--------|------|-------|-----------|------|-----|---------|
| | 115 | 4.5 | 1.0 | 0.6 | 0.3 | 10.5 | 1 | .19 | \$38.98 |



Made in Germany

www.wihatools.com

Click image to view web page

Wiha ESD Safe Pliers & Cutters

Diagonal Cutters Slim Oval Form

Form 2 - Full Flush

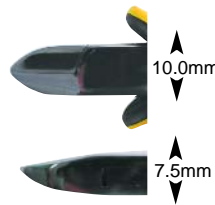
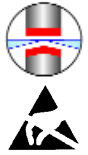

327 14 Diagonal Cutters, Slim Oval Head, Form 2 - Full Flush

Side Cutters drop-forged for an ideal material structure. Precise aligned cutting edges are additionally induction hardened at a hardness of Approx. 64°HRC. Two component non-slip soft grip handle, ESD Safe Dissipative.

| #327 14 | mm | Inch | Copper | Iron | Steel | Head Wdth | Pkg. | wt. | Each |
|---------|-----|------|--------|------|-------|-----------|------|-----|---------|
| | 115 | 4.5 | 1.0 | - | - | 10.0 | 1 | .19 | \$42.98 |

Diagonal Cutters Slim Oval Form

Form 1 - Bevel

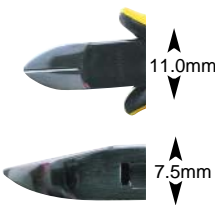
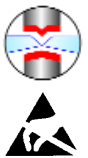

327 16 Diagonal Cutters, Wide Oval Head, Form 1 - Bevel

Side Cutters drop-forged for an ideal material structure. Precise aligned cutting edges are additionally induction hardened at a hardness of Approx. 64°HRC. Two component non-slip soft grip handle, ESD Safe Dissipative.

| #327 16 | mm | Inch | Copper | Iron | Steel | Head Wdth | Pkg. | wt. | Each |
|---------|-----|------|--------|------|-------|-----------|------|-----|---------|
| | 115 | 4.5 | 1.4 | 1.0 | 0.4 | 11.0 | 1 | .19 | \$38.48 |

Diagonal Cutters Wide Oval Form And Carbide Edge

Form 4 - Bevel

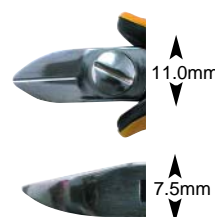

327 18 Diagonal Cutters, Wide Oval Head Carbide Cutting Edges, Form 2 - Bevel

Side Cutters drop-forged for an ideal material structure. Precise aligned carbide cutting edge. Two component non-slip soft grip handle, ESD Safe Dissipative.

| #327 18 | mm | Inch | Copper | Iron | Steel | Head Wdth | Pkg. | wt. | Each |
|---------|-----|-------|--------|------|-------|-----------|------|-----|---------|
| | 110 | 4 3/8 | 1.6 | 1.0 | 0.6 | 11.0 | 1 | .16 | \$89.98 |

Diagonal Cutters Wide Oval Form

Form 3 - Flush

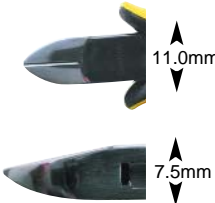
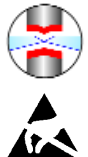

327 20 Diagonal Cutters, Wide Oval Head, Form 3 - Flush

Side Cutters drop-forged for an ideal material structure. Precise aligned cutting edges are additionally induction hardened at a hardness of Approx. 64°HRC. Two component non-slip soft grip handle, ESD Safe Dissipative.

| #327 20 | mm | Inch | Copper | Iron | Steel | Head Wdth | Pkg. | wt. | Each |
|---------|-----|------|--------|------|-------|-----------|------|-----|---------|
| | 115 | 4.5 | 1.2 | - | - | 11.0 | 1 | .19 | \$38.48 |

Diagonal Cutters Wide Oval Form

Form 4 - Flush

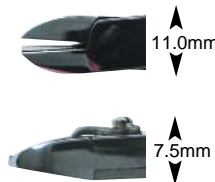
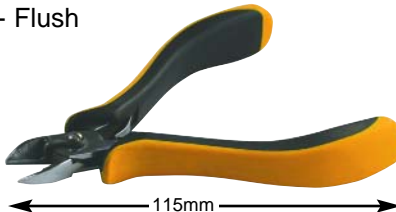
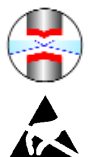

327 21 Diagonal Cutters, Wide Oval Head With Wire Trapping Device, Form 4 - Flush

Side Cutters drop-forged for an ideal material structure. Precise aligned cutting edges are additionally induction hardened at a hardness of Approx. 64°HRC. Two component non-slip soft grip handle, ESD Safe Dissipative.

| #327 21 | mm | Inch | Copper | Iron | Steel | Head Wdth | Pkg. | wt. | Each |
|---------|-----|------|--------|------|-------|-----------|------|-----|---------|
| | 115 | 4.5 | 1.2 | - | - | 11.0 | 1 | .19 | \$39.98 |



Made in Germany

Toll Free: (800) 494-6104

Click image to view web page

Wiha ESD Safe Pliers & Cutters

Oblique Angled Cutters

Form 1 - Flush

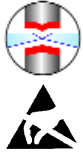

327 22 Oblique Angled Cutters, 29°, Form 1- Flush

Oblique Cutters drop-forged for an ideal material structure. Precise aligned cutting edges are additionally induction hardened at a hardness of Approx. 64°HRC. Two component non-slip soft grip handle, ESD Safe Dissipative.

| #327 22 | mm | Inch | Copper | Iron | Steel | Head Wdth | Pkg. wt. | Each |
|---------|-----|------|--------|------|-------|-----------|----------|------|
| | 115 | 4.5 | 1.2 | - | - | 12.0 | 1 | .20 |

Oblique Angled Cutters

Form 2 - Full Flush

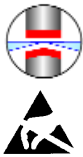

327 24 Oblique Angled Cutters, 29°, Form 2 - Full Flush

Oblique Cutters drop-forged for an ideal material structure. Precise aligned cutting edges are additionally induction hardened at a hardness of Approx. 64°HRC. Two component non-slip soft grip handle, ESD Safe Dissipative.

| #327 24 | mm | Inch | Copper | Iron | Steel | Head Wdth | Pkg. wt. | Each |
|---------|-----|------|--------|------|-------|-----------|----------|------|
| | 115 | 4.5 | 1.0 | - | - | 12.0 | 1 | .20 |

Oblique Angled Cutters

Form 3 - Semi Flush

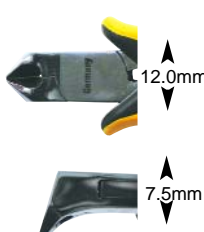
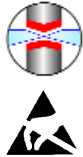

327 26 Oblique Angled Cutters, 29°, Short Head, Form 3 - Semi Flush

Oblique Cutters drop-forged for an ideal material structure. Precise aligned cutting edges are additionally induction hardened at a hardness of Approx. 64°HRC. Two component non-slip soft grip handle, ESD Safe Dissipative.

| #327 26 | mm | Inch | Copper | Iron | Steel | Head Wdth | Pkg. wt. | Each |
|---------|-----|------|--------|------|-------|-----------|----------|------|
| | 115 | 4.5 | 1.2 | 0.8 | 0.6 | 12.0 | 1 | .20 |

Oblique Front Cutters

Form 4 - Flush

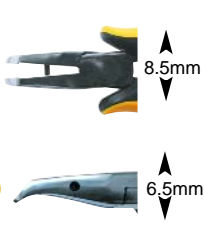
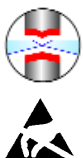

327 28 Oblique Front Cutters, Very Small Head, 40°, Form 4 - Flush

Oblique Cutters drop-forged for an ideal material structure. Precise aligned cutting edges are additionally induction hardened at a hardness of Approx. 64°HRC. Two component non-slip soft grip handle, ESD Safe Dissipative.

| #327 28 | mm | Inch | Copper | Iron | Steel | Head Wdth | Pkg. wt. | Each |
|---------|-----|-------|--------|------|-------|-----------|----------|------|
| | 110 | 4 3/8 | 0.6 | - | - | 8.5 | 1 | .13 |



Made in Germany

www.wihatools.com

Click image to view web page

Wiha ESD Safe Pliers & Cutters

End Cutters Extra Slim

Form 1 - Semi Flush

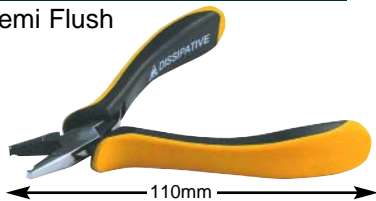
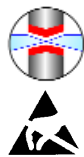

Tip Width

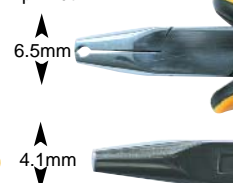

327 32 End Cutters, Extra Slim, Form 1 - Flush

End Cutters drop-forged for an ideal material structure. Precise aligned cutting edges are additionally induction hardened at a hardness of Approx. 64°HRC. Two component non-slip soft grip handle, ESD Safe Dissipative.

| #327 32 | mm | Inch | Copper | Iron | Steel | Tip Wdth | Pkg. | wt. | Each |
|---------|-----|-------|--------|------|-------|----------|------|-----|---------|
| | 110 | 4 3/8 | 0.6 | - | - | 4.1 | 1 | .16 | \$43.48 |

End Cutters Wide Head

Form 2 - Flush

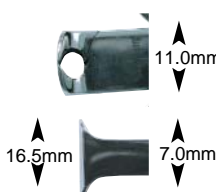
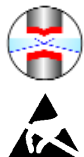

327 34 End Cutters, Wide Head, Form 2 - Flush

End Cutters drop-forged for an ideal material structure. Precise aligned cutting edges are additionally induction hardened at a hardness of Approx. 64°HRC. Two component non-slip soft grip handle, ESD Safe Dissipative.

| #327 34 | mm | Inch | Copper | Iron | Steel | Head Wdth | Pkg. | wt. | Each |
|---------|-----|------|--------|------|-------|-----------|------|-----|---------|
| | 115 | 4.5 | 1.4 | - | - | 11.0 | 1 | .18 | \$43.98 |

ESD Safe Pliers

Short Snipe Nose

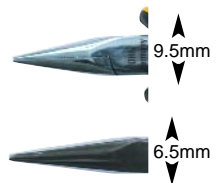

327 42 ESD Safe Pliers, Short Snipe Nose (Chain Nose) Straight, Serrated Jaws

Pliers drop-forged for an ideal material structure. Precisely aligned, jaws, hardened. Two component non-slip soft grip handle, ESD Safe Dissipative.

| #327 42 | mm | Inch | Copper | Iron | Steel | Head Wdth | Pkg. | wt. | Each |
|---------|-----|-------|--------|------|-------|-----------|------|-----|---------|
| | 120 | 4 3/4 | - | - | - | 9.5 | 1 | .17 | \$34.98 |

ESD Safe Pliers

Snipe Nose

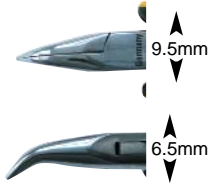

327 44 ESD Safe Pliers, Snipe Nose (Chain Nose) Bent 45°, Smooth Jaws

Pliers drop-forged for an ideal material structure. Precisely aligned, jaws, hardened. Two component non-slip soft grip handle, ESD Safe Dissipative.

| #327 44 | mm | Inch | Copper | Iron | Steel | Head Wdth | Pkg. | wt. | Each |
|---------|-----|-------|--------|------|-------|-----------|------|-----|---------|
| | 120 | 4 3/4 | - | - | - | 9.5 | 1 | .16 | \$35.98 |

ESD Safe Pliers

Long Needle Nose

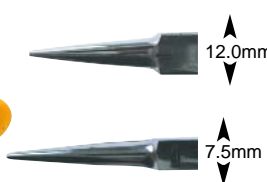

327 46 ESD Safe Pliers, Long Needle Nose Pliers, Straight, Serrated Jaws

Pliers drop-forged for an ideal material structure. Precisely aligned, jaws, hardened. Two component non-slip soft grip handle, ESD Safe Dissipative.

| #327 46 | mm | Inch | Copper | Iron | Steel | Head Wdth | Pkg. | wt. | Each |
|---------|-----|-------|--------|------|-------|-----------|------|-----|---------|
| | 145 | 5 3/4 | - | - | - | 12.0 | 1 | .21 | \$39.98 |



Made in Germany

Toll Free: (800) 494-6104

Click image to view web page

Wiha ESD Safe Pliers & Cutters

ESD Safe Pliers

Needle Nose, Bent 90°

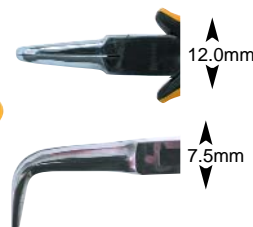

327 48 ESD Safe Pliers, Needle Nose Pliers, Bent 90°, Smooth Jaws

Pliers drop-forged for an ideal material structure. Precisely aligned, jaws, hardened. Two component non-slip soft grip handle, ESD Safe Dissipative.

| #327 48 | mm | Inch | Copper | Iron | Steel | Head Wdth | Pkg. | wt. | Each |
|---------|-----|-------|--------|------|-------|-----------|------|-----|---------|
| | 145 | 5 3/4 | - | - | - | 12.0 | 1 | .21 | \$39.98 |

ESD Safe Pliers

Short Round Nose Pliers

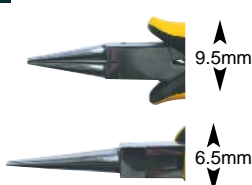

327 50 ESD Safe Pliers, Short Round Nose Pliers, Smooth Jaws

Pliers drop-forged for an ideal material structure. Precisely aligned, jaws, hardened. Two component non-slip soft grip handle, ESD Safe Dissipative.

| #327 50 | mm | Inch | Copper | Iron | Steel | Head Wdth | Pkg. | wt. | Each |
|---------|-----|-------|--------|------|-------|-----------|------|-----|---------|
| | 120 | 4 3/4 | - | - | - | 9.5 | 1 | .17 | \$34.98 |

ESD Safe Pliers

Short Flat Nose Pliers

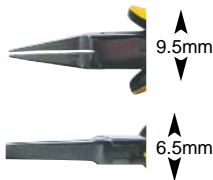

327 52 ESD Safe Pliers, Short Flat Nose Pliers, Smooth Jaws

Pliers drop-forged for an ideal material structure. Precisely aligned, jaws, hardened. Two component non-slip soft grip handle, ESD Safe Dissipative.

| #327 52 | mm | Inch | Copper | Iron | Steel | Head Wdth | Pkg. | wt. | Each |
|---------|-----|-------|--------|------|-------|-----------|------|-----|---------|
| | 120 | 4 3/4 | - | - | - | 9.5 | 1 | .16 | \$34.98 |



327 90 4 Pc. ESD Safe Pliers Set In Custom Case

Pliers drop-forged for an ideal material structure. Two component non-slip soft grip handle. ESD Safe Dissipative.

#327 90 4 piece ESD Safe Pliers Set

Set includes:

| | |
|-------------------------|------------------------|
| 32716 Oval Side Cutters | 32746 Long Nose Pliers |
| 32752 Flat Nose Pliers | 32728 Oblique Cutters |

Each \$169.98



327 91 11 Pc. Set, 4 ESD Safe Pliers, SYSTEM 4 Slotted & Phillips

5 Pc. Set & 2 ESD Safe Tweezers Pliers drop-forged for an ideal material structure. Two component non-slip soft grip handle. ESD Safe Precision handle & 4 CVM tool steel blades. Tweezers anti-static conductive, ESD Safe Hypo allergenic, anti magnetic stainless.

#327 91 11 piece ESD Safe Pliers, Tweezers & SYS 4 precision

Set in custom case includes: Each \$229.98

ESD Safe Pliers & Cutters

| | |
|-------------------------|------------------------|
| 32716 Oval Side Cutters | 32746 Long Nose Pliers |
| 32752 Flat Nose Pliers | 32728 Oblique Cutters |

SYSTEM 4 Set in separate pouch

28000 ESD Safe Conductive Precision Handle

Slotted: 1.5, 2.0, 3.0 & 4.0

Phillips: 000, 00, 0 & 1

ESD Safe Tweezers: 44501 AA SA ESD 44510 7a SA ESD

Each \$229.98



Made in Germany

www.wihatools.com

Click on page number to view product

Wiha Precision Index

| | Description | Page |
|--|----------------------------------|----------|
| | ESD Safe Slotted Prec Drivers | 110-111 |
| | ESD Safe Phillips Prec Drivers | 110-111 |
| | ESD Safe Torx Prec Drivers | 111 |
| | ESD Safe Hex Prec Drivers | 112 |
| | ESD Safe Nut Drivers | 112 |
| | ESD Safe Chip Lifter | 117 |
| | Ceramic Slotted/Phillips Drivers | 112 |
| | Precision Slotted Drivers | 113-114 |
| | Precision Phillips Drivers | 113-114 |
| | Precision Pozidriv Drivers | 115 |
| | Precision Hex Drivers | 114 |
| | Precision Ball End Hex Drivers | 115 |
| | Precision Nut Drivers | 116 |
| | Precision Torx Drivers | 117, 176 |
| | Precision Chip Lifter | 117 |
| | Pocket Clip | 117 |
| | Precision Tool Rack | 117 |
| | Protorn Prec Slotted Drivers | 118 |
| | Protorn Prec Phillips Drivers | 118 |
| | Protorn Prec Hex Drivers | 119 |
| | Protorn Prec Ball End Drivers | 119 |
| | Protorn Bit Holding Driver | 119 |
| | Protorn Chip Lifter | 119 |
| | Protorn Torx Drivers | 120 |
| | SYSTEM 4 Handles | 122 |
| | SYSTEM 4 Blades | 122-123 |
| | SYSTEM 4 Sets | 124-126 |
| | SYSTEM 4 Micro Bit Handles | 127 |
| | SYSTEM 4 Micro Bits | 127-128 |
| | SYSTEM 4 Micro Bit Sets | 128-129 |

Precision ESD Safe Conductive Drivers

Wiha Precision ESD Static Dissipative Screwdrivers meet the requirements for tools used in electrostatic sensitive areas.



Rotating cap for precise turning & control with fingertip

Molded Precision handle of impact resistant conductive material

Tapered handle allows rapid rotation

Blade, CVM steel, hardened, chrome-plated.

Tip, precision ground for exact fit, Wiha Chromtop finish.

Surface resistance of handles is 10⁶ - 10⁹ Ohms.



272 Slotted Screwdriver, With Precision ESD Safe Conductive Handle.

Blade high alloy chrome-vanadium-molybdenum steel, hardened, chrome-plated, tip Wiha-Chromtop. Handle manufactured from impact resistant, conductive material.

| Item | | | | | | | | | | | | | |
|--------|-----|------|----|------|------|------|-----|------|------|------|--------|--|--|
| No. | mm | Inch | mm | Inch | mm | Inch | mm | Inch | lbs. | pkg. | Each | | |
| 272 15 | 1.5 | 1/16 | 40 | 1.6 | 0.25 | .010 | 120 | 4.72 | .02 | 10 | \$5.20 | | |
| 272 20 | 2.0 | 5/64 | 40 | 1.6 | 0.40 | .016 | 120 | 4.72 | .02 | 10 | \$4.48 | | |
| 272 25 | 2.5 | 3/32 | 50 | 2.0 | 0.40 | .016 | 145 | 5.71 | .04 | 10 | \$4.48 | | |
| 272 30 | 3.0 | 1/8 | 50 | 2.0 | 0.50 | .020 | 145 | 5.71 | .04 | 10 | \$4.08 | | |
| 272 35 | 3.5 | 9/64 | 60 | 2.4 | 0.60 | .024 | 170 | 6.69 | .06 | 10 | \$4.88 | | |
| 272 40 | 4.0 | 5/32 | 60 | 2.4 | 0.80 | .031 | 170 | 6.69 | .06 | 10 | \$4.98 | | |



273 Phillips Screwdriver, With Precision ESD Safe Conductive Handle.

Blade high alloy chrome-vanadium-molybdenum steel, hardened, chrome-plated, tip Wiha-Chromtop. Handle manufactured from impact resistant, conductive material.

| Item | | | | | | | | | | | | | |
|--------|------|----|------|-----|------|-----|------|------|------|--------|--|--|--|
| No. | Size | mm | Inch | mm | Inch | mm | Inch | lbs. | pkg. | Each | | | |
| 273 02 | 000 | 40 | 1.6 | 2.0 | .079 | 120 | 4.7 | .02 | 10 | \$6.90 | | | |
| 273 05 | 00 | 40 | 1.6 | 2.0 | .079 | 120 | 4.7 | .02 | 10 | \$5.10 | | | |
| 273 10 | 0 | 50 | 2.0 | 3.0 | .118 | 145 | 5.7 | .04 | 10 | \$4.80 | | | |
| 273 20 | 1 | 60 | 2.3 | 4.0 | .157 | 170 | 6.7 | .06 | 10 | \$4.88 | | | |



Made in Germany

Toll Free: (800) 494-6104

Click image to view web page

Precision ESD Safe Conductive Drivers



273 90 Set 7 Pcs. Slotted & Phillips Precision ESD Safe Conductive Handle. Blade high alloy CVM steel, hardened, chrome-plated, tip Wiha-Chromtop. Handle manufactured from impact resistant, conductive material.

| Item No. | Slotted mm | Phillips mm | Size | Weight lbs. |
|----------|------------|-------------|--------------|-------------|
| 273 90 | 272 15 | 1.5 40 | 273 05 00 40 | .30 |
| | 272 20 | 2.0 40 | 273 10 0 50 | |
| | 272 25 | 2.5 50 | 273 20 1 60 | Each |
| | 272 35 | 3.5 60 | | \$31.98 |



920 91 Master Technicians Bench Top Set
Plexiglass frame. Equipped with 34 precision ESD Safe screwdrivers.

| Item No. | Contents |
|-----------|--|
| 920 91 | Slotted: 1.5, 2.0, 2.5, 3.0, 3.5, 4.0mm Phillips: #00, #0, #1 |
| | Torx: T1, T2, T3, T4, T5, T6, T7, T8, T9, T10, T15, T20 |
| lbs. 2.25 | Metric Hex: 1.3, 1.5, 2.0, 2.5, 3.0 |
| Each | Metric Nut Drivers: 2.5, 3.0, 3.5, 4.0, 4.5, 5.0, 5.5 |
| \$183.40 | 279 20 Chip Lifter |



278 TORX® Screwdriver, With Precision ESD Safe Conductive handle. Blade high alloy CVM steel, hardened, chrome-plated, tip Wiha-Chromtop. Handle impact resistant, conductive material.

| Item No. | Size | mm | Inch | mm | Inch | lbs. | pkg. | Each |
|----------|------|----|------|-----|------|------|------|--------|
| 278 01 | T1 | 40 | 1.57 | 120 | 4.7 | .03 | 10 | \$6.62 |
| 278 02 | T2 | 40 | 1.57 | 120 | 4.7 | .03 | 10 | \$6.62 |
| 278 03 | T3 | 40 | 1.57 | 120 | 4.7 | .03 | 10 | \$6.62 |
| 278 04 | T4 | 40 | 1.57 | 120 | 4.7 | .03 | 10 | \$6.62 |
| 278 05 | T5 | 40 | 1.57 | 120 | 4.7 | .03 | 10 | \$6.62 |
| 278 11 | T6 | 40 | 1.57 | 120 | 4.7 | .03 | 10 | \$6.62 |
| 278 17 | T7 | 40 | 1.57 | 120 | 4.7 | .03 | 10 | \$6.62 |
| 278 23 | T8 | 40 | 1.57 | 120 | 4.7 | .03 | 10 | \$6.62 |
| 278 29 | T9 | 50 | 1.97 | 145 | 5.7 | .04 | 10 | \$6.62 |
| 278 35 | T10 | 50 | 1.97 | 145 | 5.7 | .04 | 10 | \$6.92 |
| 278 41 | T15 | 60 | 2.36 | 170 | 6.7 | .07 | 10 | \$7.02 |
| 278 47 | T20 | 60 | 2.36 | 170 | 6.7 | .07 | 10 | \$7.14 |



278 90 Set 7 Pcs. TORX® Precision ESD Safe conductive handle
Blade high alloy CVM steel, hardened, chrome-plated, tip Wiha-Chromtop. Handle manufactured from impact resistant, conductive material.

| Item No. | Slotted mm | Torx mm | Size | mm | lbs. |
|----------|------------|---------|--------|--------|---------|
| 278 90 | 272 15 | T4 40 | 273 05 | T8 40 | .31 |
| | 272 20 | T5 40 | 273 10 | T9 50 | |
| | 272 25 | T6 40 | 273 20 | T10 50 | Each |
| | 272 35 | T7 40 | | | \$33.98 |



278 91 Set 7 Pcs. TORX® Precision ESD Safe conductive handle
Blade high alloy CVM steel, hardened, chrome-plated, tip Wiha-Chromtop. Handle manufactured from impact resistant, conductive material.

| Item No. | Slotted mm | Torx mm | Size | mm | lbs. |
|----------|------------|---------|--------|-------------|---------|
| 278 91 | 278 01 | T1 40 | 278 05 | T5 40 | .30 |
| | 278 02 | T2 40 | 278 06 | T6 40 | |
| | 278 03 | T3 40 | 278 07 | T7 40 | Each |
| | 278 04 | T4 40 | 279 20 | Chip Lifter | \$49.98 |



Made in Germany

www.wihatools.com

Click image to view web page

Wiha Precision ESD Safe Screwdrivers



275 Metric Hex Driver, With Precision ESD Safe Conductive Handle.

Blade high alloy chrome-vanadium-molybdenum steel, hardened, chrome-plated, tip Wiha-Chromtop. Handle manufactured from impact resistant, conductive material.

| Item | | | | | | | | | |
|--------|-----|----|------|-----|------|------|------|--------|--|
| No. | mm | mm | Inch | mm | Inch | lbs. | pkg. | Each | |
| 275 13 | 1.3 | 40 | 1.6 | 120 | 4.72 | .03 | 10 | \$4.90 | |
| 275 15 | 1.5 | 50 | 2.0 | 145 | 5.71 | .03 | 10 | \$4.60 | |
| 275 20 | 2.0 | 50 | 2.0 | 145 | 5.71 | .04 | 10 | \$4.18 | |
| 275 25 | 2.5 | 60 | 2.4 | 170 | 6.69 | .05 | 10 | \$4.28 | |
| 275 30 | 3.0 | 60 | 2.4 | 170 | 6.69 | .06 | 10 | \$3.98 | |



277 Metric Nut Driver, With Precision ESD Safe Conductive Handle.

Blade high alloy chrome-vanadium-molybdenum steel, hardened, chrome-plated, tip Wiha-Chromtop. Handle manufactured from impact resistant, conductive material.

| Item | | | | | | | | | | |
|--------|-----|----|------|-----|------|------|------|------|------|--------|
| No. | mm | mm | Inch | mm | Inch | Inch | Inch | lbs. | pkg. | Each |
| 277 25 | 2.5 | 60 | 2.36 | 155 | 6.1 | 4.0 | 4.0 | .05 | 10 | \$6.02 |
| 277 30 | 3.0 | 60 | 2.36 | 155 | 6.1 | 5.0 | 5.0 | .06 | 10 | \$6.32 |
| 277 35 | 3.5 | 60 | 2.36 | 155 | 6.1 | 5.3 | 6.0 | .06 | 10 | \$6.52 |
| 277 40 | 4.0 | 60 | 2.36 | 155 | 6.1 | 5.5 | 6.0 | .06 | 10 | \$6.74 |
| 277 50 | 5.0 | 60 | 2.36 | 155 | 6.1 | 6.8 | 7.0 | .06 | 10 | \$6.74 |
| 277 55 | 5.5 | 60 | 2.36 | 170 | 6.7 | 7.6 | 8.0 | .07 | 10 | \$6.94 |



Wiha Precision Ceramic

Handle and Blade are antimagnetic and anti-static.

Rotating cap facilitates adjusting and holding of the tools.



Blade High thermic and electric insulation.

Precision handle high quality plastic, cadmium free.

Free of contamination, suited for working in clean-rooms.



270 Ceramic Slotted Screwdriver, With Wiha-Precision Handle, Out of Anti-static Plastic.

Blade special ceramic, anti-static, antimagnetic, for correct adjusting in high frequency areas.

| Item | | | | | | | | | | | |
|--------|-----|------|----|------|------|------|------|------|------|------|---------|
| No. | mm | Inch | mm | Inch | mm | Inch | mm | Inch | lbs. | pkg. | Each |
| 270 09 | 0.9 | .035 | 15 | .591 | 0.35 | .014 | 94.5 | 3.72 | .14 | 1 | \$11.10 |
| 270 13 | 1.3 | .050 | 15 | .591 | 0.35 | .014 | 94.5 | 3.72 | .14 | 1 | \$11.10 |
| 270 18 | 1.8 | .071 | 15 | .591 | 0.45 | .018 | 94.5 | 3.72 | .14 | 1 | \$11.10 |
| 270 26 | 2.6 | .102 | 15 | .591 | 0.45 | .018 | 94.5 | 3.72 | .14 | 1 | \$11.10 |



271 Ceramic Phillips Screwdriver, With Wiha-Precision Handle, Out of Anti-static Plastic.

Blade special ceramic, anti-static, antimagnetic, for correct adjusting in high frequency areas.

| Item | | | | | | | | | |
|--------|------|------|------|------|------|------|------|---------|--|
| No. | Size | mm | Inch | mm | Inch | lbs. | pkg. | Each | |
| 271 00 | 0 | 15.0 | .591 | 94.5 | 3.72 | .14 | 1 | \$11.10 | |



270 90 Ceramic Slotted/Phillips Screwdriver 3 Pc. Set, With Wiha-Precision Handle, Out of Anti-static Plastic.

Blade special ceramic, anti-static, antimagnetic, for correct adjusting in high frequency areas.

| Item | | | | | | | | |
|--------|-----|----|------|----|------|------|---------|--|
| No. | mm | mm | Size | mm | lbs. | pkg. | Each | |
| 270 90 | 0.9 | 15 | 0 | 15 | .28 | 1 | \$33.98 | |
| | 2.6 | 15 | | | | | | |

See Precision tool stand on page 117



Made in Germany

Toll Free: (800) 494-6104

Click image to view web page

Wiha Long Life Precision Series



260 Slotted Screwdriver, With Precision Handle

Blade high alloy chrome-vanadium-molybdenum steel.

| Item | + | + | + | + | + | + | + | + | + | + | + |
|--------|-----|------|-----|------|------|------|-----|-------|------|------|--------|
| No. | mm | Inch | mm | Inch | mm | Inch | mm | Inch | lbs. | pkg. | Each |
| 260 08 | .80 | 1/32 | 40 | 1.6 | 0.16 | .007 | 120 | 4.72 | .02 | 10 | \$5.20 |
| 260 10 | 1.0 | .039 | 40 | 1.6 | 0.18 | .007 | 120 | 4.72 | .02 | 10 | \$4.80 |
| 260 12 | 1.2 | 3/64 | 40 | 1.6 | 0.20 | .008 | 120 | 4.72 | .02 | 10 | \$3.90 |
| 260 15 | 1.5 | 1/16 | 40 | 1.6 | 0.25 | .010 | 120 | 4.72 | .02 | 10 | \$3.80 |
| 260 18 | 1.8 | .070 | 40 | 1.6 | 0.30 | .012 | 120 | 4.72 | .02 | 10 | \$3.50 |
| 260 20 | 2.0 | 5/64 | 40 | 1.6 | 0.40 | .016 | 120 | 4.72 | .02 | 10 | \$3.20 |
| 260 22 | 2.0 | 5/64 | 50 | 2.0 | 0.40 | .016 | 145 | 5.71 | .02 | 10 | \$3.50 |
| 260 23 | 2.0 | 5/64 | 100 | 4.0 | 0.40 | .016 | 180 | 7.09 | .03 | 10 | \$3.50 |
| 260 25 | 2.5 | 3/32 | 50 | 2.0 | 0.40 | .016 | 145 | 5.71 | .03 | 10 | \$3.20 |
| 260 27 | 2.5 | 3/32 | 100 | 3.9 | 0.40 | .016 | 195 | 7.68 | .03 | 10 | \$3.30 |
| 260 28 | 2.5 | 3/32 | 150 | 6.0 | 0.40 | .016 | 245 | 9.61 | .04 | 10 | \$3.50 |
| 260 30 | 3.0 | 1/8 | 50 | 2.0 | 0.50 | .020 | 145 | 5.71 | .03 | 10 | \$3.20 |
| 260 32 | 3.0 | 1/8 | 60 | 2.4 | 0.50 | .020 | 170 | 6.69 | .04 | 10 | \$3.40 |
| 260 33 | 3.0 | 1/8 | 100 | 4.0 | 0.50 | .020 | 210 | 8.27 | .04 | 10 | \$3.40 |
| 260 34 | 3.0 | 1/8 | 150 | 6.0 | 0.50 | .020 | 260 | 10.24 | .05 | 10 | \$3.80 |
| 260 35 | 3.5 | 9/64 | 60 | 2.4 | 0.60 | .024 | 170 | 6.69 | .05 | 10 | \$3.50 |
| 260 40 | 4.0 | 5/32 | 60 | 2.4 | 0.80 | .031 | 170 | 6.69 | .05 | 10 | \$3.60 |
| 260 41 | 4.0 | 5/32 | 100 | 3.9 | 0.80 | .031 | 210 | 8.27 | .06 | 10 | \$3.80 |
| 260 42 | 4.0 | 5/32 | 150 | 6.0 | 0.80 | .031 | 260 | 10.24 | .07 | 10 | \$4.30 |



260 90 Set 6 Pcs. Slotted

Blade high alloy chrome-vanadium-molybdenum steel, hardened, chrome-plated.

| Item | + | + | + | |
|--------|--------|-----|------|---------|
| No. | mm | mm | lbs. | |
| 260 90 | 260 15 | 1.5 | 40 | .27 |
| | 260 20 | 2.0 | 40 | |
| | 260 25 | 2.5 | 50 | |
| | 260 30 | 3.0 | 50 | |
| | 260 35 | 3.5 | 60 | Each |
| | 260 40 | 4.0 | 60 | \$20.98 |



261 Phillips Screwdriver, With Precision Handle

Blade high alloy chrome-vanadium-molybdenum steel.

| Item | + | + | + | + | + | + | + | + | + | + | + |
|--------|------|-----|------|-----|------|-----|------|------|------|--------|---|
| No. | Size | mm | Inch | mm | Inch | mm | Inch | lbs. | pkg. | Each | |
| 261 02 | 000 | 40 | 1.6 | 2.0 | .079 | 120 | 4.7 | .02 | 10 | \$5.10 | |
| 261 00 | 00 | 40 | 1.6 | 2.0 | .079 | 120 | 4.7 | .02 | 10 | \$3.90 | |
| 261 01 | 00 | 75 | 3.0 | 2.0 | .079 | 155 | 6.1 | .02 | 10 | \$3.90 | |
| 261 05 | 0 | 50 | 2.0 | 3.0 | .118 | 145 | 5.7 | .02 | 10 | \$3.50 | |
| 261 08 | 0 | 75 | 3.0 | 3.0 | .118 | 170 | 6.7 | .03 | 10 | \$3.40 | |
| 261 07 | 0 | 100 | 4.0 | 3.0 | .118 | 195 | 7.6 | .05 | 10 | \$3.60 | |
| 261 09 | 0 | 150 | 5.9 | 3.0 | .118 | 245 | 9.6 | .06 | 10 | \$3.90 | |
| 261 10 | 1 | 60 | 2.4 | 4.0 | .157 | 170 | 6.7 | .05 | 10 | \$3.60 | |
| 261 13 | 1 | 80 | 3.1 | 4.0 | .157 | 190 | 7.5 | .05 | 10 | \$3.80 | |
| 261 14 | 1 | 100 | 3.9 | 4.0 | .157 | 210 | 8.2 | .06 | 10 | \$3.80 | |
| 261 15 | 1 | 150 | 5.9 | 4.0 | .157 | 260 | 10.2 | .07 | 10 | \$4.30 | |

Rotating cap
for precise turning and control with fingertip.

Precision handle
high quality plastic, cadmium free.

Molded on tapered handle
allows rapid rotation.

High performance blades
chrome-vanadium-molybdenum steel, hardened, chrome-plated.

Tip
precision ground for exact fit. Vapor chromed non-slip surface.

See Carded Precision Screwdrivers On Page 121



Made in Germany

www.wihatools.com

Click image to view web page

Wiha Precision Series



261 90 Set 7 Pcs. Slotted & Phillips
Blade high alloy chrome-vanadium-molybdenum steel.

| Item | Slotted | Phillips | |
|--------|---------|----------|------------|
| No. | mm | mm | lbs. |
| 261 90 | 260 15 | 1.5 | 40 .31 |
| | 260 22 | 2.0 | 50 |
| | 260 25 | 2.5 | 50 |
| | 260 32 | 3.0 | 60 |
| | | Phillips | Slotted |
| | | mm | mm |
| | 261 00 | 00 | 40 |
| | 261 05 | 0 | 50 Each |
| | 261 10 | 1 | 60 \$23.98 |



263 Metric Hex Driver, With Precision Handle
Metric sizes. Blade high alloy chrome-vanadium-molybdenum steel.

| Item | Hex | Slotted | Phillips | | | | | | |
|--------|------|---------|----------|------|-----|------|------|------|--------|
| No. | mm | Inch | mm | Inch | mm | Inch | lbs. | pkg. | Each |
| 263 07 | 0.7 | .028 | 40 | 1.6 | 120 | 4.72 | .02 | 10 | \$3.90 |
| 263 09 | 0.9 | .035 | 40 | 1.6 | 120 | 4.72 | .02 | 10 | \$3.80 |
| 263 13 | 1.27 | .050 | 40 | 1.6 | 120 | 4.72 | .02 | 10 | \$3.30 |
| 263 15 | 1.5 | - | 50 | 2.0 | 145 | 5.71 | .03 | 10 | \$3.30 |
| 263 20 | 2.0 | 5/64 | 50 | 2.0 | 145 | 5.71 | .03 | 10 | \$3.00 |
| 263 25 | 2.5 | - | 60 | 2.4 | 170 | 6.69 | .04 | 10 | \$3.00 |
| 263 30 | 3.0 | - | 60 | 2.4 | 170 | 6.69 | .04 | 10 | \$3.00 |



260 92 Set 7 Pcs. Slotted & Phillips
Blade high alloy chrome-vanadium-molybdenum steel.

| Item | Slotted | Phillips | |
|--------|---------|----------|---------|
| No. | mm | mm | lbs. |
| 260 92 | 260 25 | 2.5 | 50 .30 |
| | 260 27 | 2.5 | 100 |
| | 260 33 | 3.0 | 100 |
| | 260 34 | 3.0 | 150 |
| | 260 41 | 4.0 | 100 |
| | 260 42 | 4.0 | 150 |
| | | Phillips | Slotted |
| | | mm | mm |
| | 261 08 | 0 | 75 Each |
| | | | \$25.98 |



263 90 Set 7 Pcs. Hex Driver Metric
Blade high alloy chrome-vanadium-molybdenum steel.

| Item | Hex | Slotted | Phillips |
|--------|--------|---------|------------|
| No. | mm | mm | lbs. |
| 263 90 | 263 07 | 0.7 | 40 .28 |
| | 263 09 | 0.9 | 40 |
| | 263 13 | 1.3 | 40 |
| | 263 15 | 1.5 | 50 |
| | 263 20 | 2.0 | 50 |
| | 263 25 | 2.5 | 60 Each |
| | 263 30 | 3.0 | 60 \$23.98 |



261 94 Set 4 Pcs. Phillips
Blade high alloy chrome-vanadium-molybdenum steel.

Item No. 261 94 000 x 40, 00 x 40, 0 x 50, 1 x 60 Each \$16.98



263 Inch Hex Driver, With Precision Handle
Inch sizes. Blade high alloy chrome-vanadium-molybdenum steel.

| Item | Hex | Slotted | Phillips | | | | | | |
|--------|------|---------|----------|------|-----|------|------|------|--------|
| No. | Inch | mm | mm | Inch | mm | Inch | lbs. | pkg. | Each |
| 263 07 | .028 | 0.7 | 40 | 1.6 | 120 | 4.72 | .02 | 10 | \$3.90 |
| 263 09 | .035 | 0.9 | 40 | 1.6 | 120 | 4.72 | .02 | 10 | \$3.80 |
| 263 13 | .050 | 1.27 | 40 | 1.6 | 120 | 4.72 | .02 | 10 | \$3.30 |
| 263 16 | 1/16 | - | 50 | 2.0 | 145 | 5.71 | .03 | 10 | \$3.30 |
| 263 20 | 5/64 | 2.0 | 50 | 2.0 | 145 | 5.71 | .03 | 10 | \$3.00 |
| 263 23 | 3/32 | - | 60 | 2.4 | 170 | 6.70 | .04 | 10 | \$3.00 |
| 263 27 | 7/64 | - | 60 | 2.4 | 170 | 6.70 | .04 | 10 | \$3.00 |
| 263 31 | 1/8 | - | 60 | 2.4 | 170 | 6.70 | .04 | 10 | \$3.00 |



261 92 Set 5 Pcs. Slotted & Phillips
Blade high alloy chrome-vanadium-molybdenum steel.

| Item | Slotted | Phillips | |
|--------|---------|----------|-------------|
| No. | mm | mm | lbs. |
| 261 92 | 260 28 | 2.5 | 150 .44 |
| | 260 34 | 3.0 | 150 |
| | 260 42 | 4.0 | 150 |
| | | Phillips | Slotted |
| | | mm | mm |
| | 261 09 | 0 | 150 Each |
| | 261 15 | 1 | 150 \$20.98 |



263 91 Set 8 Pcs. Hex Driver Inch
Blade high alloy chrome-vanadium-molybdenum steel.

| Item | Hex | Slotted | Phillips |
|--------|--------|---------|-------------|
| No. | Inch | Inch | lbs. |
| 263 91 | 263 07 | .028 | 1.6 .32 |
| | 263 09 | .035 | 1.6 |
| | 263 13 | .050 | 1.6 |
| | 263 16 | 1/16 | 2.0 |
| | 263 20 | 5/64 | 2.0 |
| | 263 23 | 3/32 | 2.4 |
| | 263 27 | 7/64 | 2.4 Each |
| | 263 31 | 1/8 | 2.4 \$25.98 |



Made in Germany

Toll Free: (800) 494-6104

Click image to view web page

Wiha Precision Series

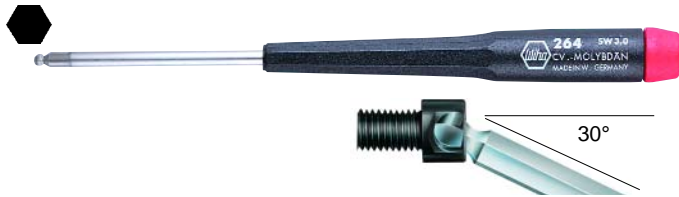

264 Inch Ball End, Hex Driver, Inch, With Precision Handle

Angle entry up to 30°. Blade high alloy chrome-vanadium-molybdenum steel.

| Item | | | | | | | | | |
|--------|------|----|------|-----|------|------|------|--------|--|
| No. | Inch | mm | Inch | mm | Inch | lbs. | pkg. | Each | |
| 264 13 | .050 | 40 | 1.57 | 120 | 4.72 | .02 | 10 | \$3.90 | |
| 264 16 | 1/16 | 50 | 1.97 | 145 | 5.71 | .03 | 10 | \$3.90 | |
| 264 19 | 5/64 | 50 | 1.97 | 145 | 5.71 | .03 | 10 | \$3.90 | |
| 264 23 | 3/32 | 50 | 1.97 | 145 | 5.71 | .03 | 10 | \$3.90 | |
| 264 27 | 7/64 | 60 | 2.36 | 170 | 6.69 | .03 | 10 | \$3.90 | |
| 264 31 | 1/8 | 60 | 2.36 | 170 | 6.69 | .05 | 10 | \$3.90 | |
| 264 36 | 9/64 | 60 | 2.36 | 170 | 6.69 | .05 | 10 | \$3.90 | |
| 264 39 | 5/32 | 60 | 2.36 | 170 | 6.69 | .05 | 10 | \$3.90 | |

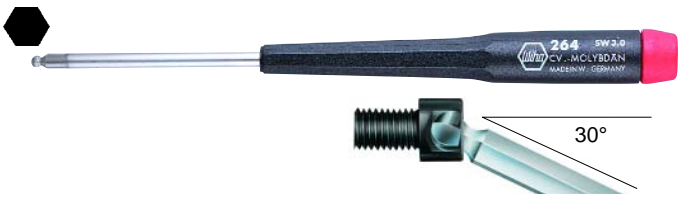

264 Metric Ball End, Hex Driver, Metric, With Precision Handle

Angle entry up to 30°. Blade high alloy chrome-vanadium-molybdenum steel.

| Item | | | | | | | | | |
|--------|-----|------|----|------|-----|------|------|------|--------|
| No. | mm | Inch | mm | Inch | mm | Inch | lbs. | pkg. | Each |
| 264 13 | 1.3 | .050 | 40 | 1.57 | 120 | 4.72 | .02 | 10 | \$3.90 |
| 264 15 | 1.5 | - | 50 | 1.97 | 145 | 5.71 | .03 | 10 | \$3.90 |
| 264 20 | 2.0 | - | 50 | 1.97 | 145 | 5.71 | .03 | 10 | \$3.90 |
| 264 25 | 2.5 | - | 60 | 2.36 | 170 | 6.69 | .04 | 10 | \$3.90 |
| 264 30 | 3.0 | - | 60 | 2.36 | 170 | 6.69 | .05 | 10 | \$3.90 |



264 90 Set 8 Pcs. Ball End Hex Driver

Inch Angle entry up to 30°. Blade high alloy chrome-vanadium-molybdenum steel.

| Item | | | | |
|--------|--------|------|------|---------|
| No. | Inch | Inch | lbs. | |
| 264 90 | 264 13 | .050 | 1.6 | .40 |
| | 264 16 | 1/16 | 2.0 | |
| | 264 19 | 5/64 | 2.0 | |
| | 264 23 | 3/32 | 2.0 | |
| | 264 27 | 7/64 | 2.4 | |
| | 264 31 | 1/8 | 2.4 | |
| | 264 36 | 9/64 | 2.4 | Each |
| | 264 39 | 5/32 | 2.4 | \$30.98 |



264 91 Set 5 Pcs. Ball End Hex Driver

Metric Angle entry up to 30°. Blade high alloy chrome-vanadium-molybdenum-steel.

| Item | | | | |
|--------|--------|-----|------|---------|
| No. | mm | mm | lbs. | |
| 264 91 | 264 13 | 1.3 | 40 | .25 |
| | 264 15 | 1.5 | 50 | |
| | 264 20 | 2.0 | 50 | |
| | 264 25 | 2.5 | 60 | Each |
| | 264 30 | 3.0 | 60 | \$18.98 |



262 Pozidriv® Screwdriver, With Precision Handle

Blade high alloy chrome-vanadium-molybdenum steel.

| Item | | | | | | | | | | |
|--------|------|----|------|-----|------|-----|------|------|------|--------|
| No. | Size | mm | Inch | mm | Inch | mm | Inch | lbs. | pkg. | Each |
| 262 05 | 0 | 50 | 2.0 | 3.0 | .118 | 145 | 5.7 | .03 | 10 | \$3.60 |
| 262 10 | 1 | 60 | 2.4 | 4.0 | .157 | 170 | 6.7 | .05 | 10 | \$3.60 |



Made in Germany

www.wihatools.com

Click image to view web page

Wiha Precision Series



265 Metric Nut Driver, With Precision Handle

Metric sizes. Blade CVM steel, hardened, chrome-plated.

| Item | ⊙ | — | — | — | — | — | — | — | — | — | — | — | — |
|--------|-----|----|------|-----|------|-----|------|------|------|--------|---|---|---|
| No. | mm | mm | Inch | mm | Inch | mm | mm | lbs. | pkg. | Each | | | |
| 265 10 | 1.5 | 60 | 2.36 | 140 | 5.5 | 2.5 | 3.0 | .03 | 10 | \$3.90 | | | |
| 265 15 | 1.8 | 60 | 2.36 | 140 | 5.5 | 2.9 | 3.5 | .03 | 10 | \$3.90 | | | |
| 265 20 | 2.0 | 60 | 2.36 | 140 | 5.5 | 3.2 | 4.0 | .04 | 10 | \$4.10 | | | |
| 265 25 | 2.5 | 60 | 2.36 | 155 | 6.1 | 4.0 | 4.0 | .04 | 10 | \$4.20 | | | |
| 265 30 | 3.0 | 60 | 2.36 | 155 | 6.1 | 5.0 | 5.0 | .05 | 10 | \$4.30 | | | |
| 265 32 | 3.2 | 60 | 2.36 | 155 | 6.1 | 5.0 | 5.0 | .05 | 10 | \$4.40 | | | |
| 265 35 | 3.5 | 60 | 2.36 | 155 | 6.1 | 5.3 | 6.0 | .05 | 10 | \$4.50 | | | |
| 265 40 | 4.0 | 60 | 2.36 | 155 | 6.1 | 5.5 | 6.0 | .05 | 10 | \$4.50 | | | |
| 265 45 | 4.5 | 60 | 2.36 | 155 | 6.1 | 6.2 | 7.0 | .05 | 10 | \$4.60 | | | |
| 265 50 | 5.0 | 60 | 2.36 | 155 | 6.1 | 6.8 | 7.0 | .05 | 10 | \$4.60 | | | |
| 265 55 | 5.5 | 60 | 2.36 | 170 | 6.7 | 7.6 | 8.0 | .06 | 10 | \$4.80 | | | |
| 265 60 | 6.0 | 60 | 2.36 | 170 | 6.7 | 8.2 | 9.0 | .06 | 10 | \$4.80 | | | |
| 265 70 | 7.0 | 60 | 2.36 | 170 | 6.7 | 9.6 | 10.0 | .06 | 10 | \$4.80 | | | |

265 Inch Nut Driver, With Precision Handle

Inch sizes. Blade CVM steel, hardened, chrome-plated.

| Item | ⊙ | — | — | — | — | — | — | — | — | — | — | — | — |
|--------|------|----|------|-----|------|------|------|------|------|--------|---|---|---|
| No. | Inch | mm | Inch | mm | Inch | Inch | Inch | lbs. | pkg. | Each | | | |
| 265 23 | 3/32 | 60 | 2.36 | 155 | 6.1 | .16 | .16 | .04 | 10 | \$4.20 | | | |
| 265 27 | 7/64 | 60 | 2.36 | 155 | 6.1 | .20 | .20 | .05 | 10 | \$4.20 | | | |
| 265 31 | 1/8 | 60 | 2.36 | 155 | 6.1 | .20 | .20 | .05 | 10 | \$4.50 | | | |
| 265 36 | 9/64 | 60 | 2.36 | 155 | 6.1 | .21 | .24 | .05 | 10 | \$4.50 | | | |
| 265 39 | 5/32 | 60 | 2.36 | 155 | 6.1 | .22 | .24 | .05 | 10 | \$4.60 | | | |
| 265 47 | 3/16 | 60 | 2.36 | 155 | 6.1 | .25 | .28 | .05 | 10 | \$4.60 | | | |
| 265 56 | 7/32 | 60 | 2.36 | 170 | 6.7 | .30 | .32 | .06 | 10 | \$4.80 | | | |
| 265 63 | 1/4 | 60 | 2.36 | 170 | 6.7 | .34 | .36 | .06 | 10 | \$4.80 | | | |



265 90 Set 8 Pcs. Nut Driver Metric

Blade chrome-vanadium-molybdenum steel.

| Item | ⊙ | — | — | — |
|--------|--------|-----|------|---------|
| No. | mm | mm | lbs. | |
| 265 90 | 265 25 | 2.5 | 60 | .48 |
| | 265 30 | 3.0 | 60 | |
| | 265 35 | 3.5 | 60 | |
| | 265 40 | 4.0 | 60 | |
| | 265 45 | 4.5 | 60 | |
| | 265 50 | 5.0 | 60 | |
| | 265 55 | 5.5 | 60 | Each |
| | 265 60 | 6.0 | 60 | \$36.98 |



265 91 Set 8 Pcs. Nut Driver Inch

Blade chrome-vanadium-molybdenum steel.

| Item | ⊙ | — | — | — |
|--------|--------|------|------|---------|
| No. | Inch | Inch | lbs. | |
| 265 91 | 265 23 | 3/32 | 2.4 | .47 |
| | 265 27 | 7/64 | 2.4 | |
| | 265 31 | 1/8 | 2.4 | |
| | 265 36 | 9/64 | 2.4 | |
| | 265 39 | 5/32 | 2.4 | |
| | 265 47 | 3/16 | 2.4 | |
| | 265 56 | 7/32 | 2.4 | Each |
| | 265 63 | 1/4 | 2.4 | \$35.98 |



265 92 Set 7 Pcs. Nut Driver Metric

| Item | ⊙ | — | — | — |
|--------|--------|-----|------|---------|
| No. | mm | mm | lbs. | |
| 265 92 | 265 10 | 1.5 | 60 | .34 |
| | 265 15 | 1.8 | 60 | |
| | 265 20 | 2.0 | 60 | |
| | 265 25 | 2.5 | 60 | |
| | 265 30 | 3.0 | 60 | |
| | 265 35 | 3.5 | 60 | Each |
| | 265 40 | 4.0 | 60 | \$28.98 |



Made in Germany

Toll Free: (800) 494-6104

Click image to view web page

Wiha Precision Series



267 TORX® Screwdriver, With Precision Handle

Blade high alloy chrome-vanadium-molybdenum steel.

| Item | Star | mm | Inch | mm | Inch | lbs. | pkg. | Each |
|--------|------|----|------|-----|------|------|------|--------|
| 267 03 | T3 | 40 | 1.57 | 120 | 4.7 | .02 | 10 | \$4.50 |
| 267 04 | T4 | 40 | 1.57 | 120 | 4.7 | .02 | 10 | \$4.50 |
| 267 05 | T5 | 40 | 1.57 | 120 | 4.7 | .02 | 10 | \$4.50 |
| 267 06 | T6 | 40 | 1.57 | 120 | 4.7 | .02 | 10 | \$4.60 |
| 267 07 | T7 | 40 | 1.57 | 120 | 4.7 | .02 | 10 | \$4.60 |
| 267 08 | T8 | 40 | 1.57 | 120 | 4.7 | .03 | 10 | \$4.60 |
| 267 09 | T9 | 50 | 1.97 | 145 | 5.7 | .03 | 10 | \$4.60 |
| 267 10 | T10 | 50 | 1.97 | 145 | 5.7 | .03 | 10 | \$4.80 |
| 267 15 | T15 | 60 | 2.36 | 170 | 6.7 | .05 | 10 | \$4.80 |
| 267 20 | T20 | 60 | 2.36 | 170 | 6.7 | .05 | 10 | \$4.80 |



267 90 Set 6 Pcs. TORX® Screwdriver

Blade high alloy chrome-vanadium-molybdenum steel.

| Item | Star | mm | lbs. |
|--------|------|----|---------|
| 267 90 | T6 | 40 | .25 |
| | T7 | 40 | |
| | T8 | 40 | |
| | T9 | 50 | |
| | T10 | 50 | Each |
| | T15 | 60 | \$27.98 |



267 92 Set 7 Pcs. TORX® Screwdriver

Blade high alloy chrome-vanadium-molybdenum steel.

| Item | Star | mm | lbs. |
|--------|------|----|---------|
| 267 92 | T5 | 40 | .27 |
| | T6 | 40 | |
| | T7 | 40 | |
| | T8 | 40 | |
| | T9 | 50 | |
| | T10 | 50 | Each |
| | T15 | 60 | \$32.68 |

Wiha Precision Accessories & Chip Lifter



Lifter Precision Chip Lifter

Blade chrome-vanadium-molybdenum steel, hardened, chrome-plated. Precision handle high quality plastic, impact resistant.

| Item | mm | mm | mm | mm | Inch | lbs. | pkg. | Each |
|--------|----------------------------|----|----|----|------|------|------|--------|
| 268 10 | Standard handle | | | | | | 1 | \$4.50 |
| 279 20 | ESD Safe Conductive handle | | | | | | 1 | \$5.90 |



921 90 Master Technicians Bench Top Set

Plexiglass frame. Equipped with 50 precision drivers.

| Item No. | Drivers |
|----------|---|
| 921 90 | Slotted: .8, 1.0, 1.2, 1.5, 1.8, 2.0, 2.5, 3.0, 3.5, 4.0 Phillips: #000, #00, #0, #1 Torx: T1, T2, T3, T4, T5, T6, T7, T8, T9, T10 Metric Hex: 1.3, 1.5, 2.0, 2.5, 3.0 Inch Hex: .028, .035, .050, 1/16, 5/64, 3/32, 7/64, 1/8, 9/64, 5/32" |
| Each | Metric Nut Drivers: 1.5, 1.8, 2.0, 2.5, 3.0, 3.5, 4.0, 4.5, 5.0, 5.5 |
| \$199.98 | 26810 Chip Lifter |



260 01 Pocket Clip for Precision Screwdrivers

Tool clips turn Precision Screwdrivers into Pocket Screwdrivers.

| Item | lbs. | pkg. | Each |
|--------|----------------------------|-------|--------|
| 260 01 | Fits all Precision handles | .0035 | 1 \$30 |



260 00 Plastic Precision Tool Rack

Rack holds 6 precision screwdrivers, can be set on workbench. Also has holes for hanging. Made from high quality plastic.

| Item | lbs. | pkg. | Each |
|--------|-----------------------------------|------|----------|
| 260 00 | Rack for 6 Precision screwdrivers | .08 | 1 \$2.40 |



Made in Germany

www.wihatools.com

Click image to view web page

Wiha Protturn Precision Screwdrivers

protturn

Blade
chrome-vanadium-molybdenum steel, black finish blades.

Tapered handle
allows rapid rotation.

Rotating cap
for precise turning and control with fingertip.

Tip
precision ground for exact fit.

Precision handle
high quality plastic, cadmium free.

Molded on ergonomic handle.

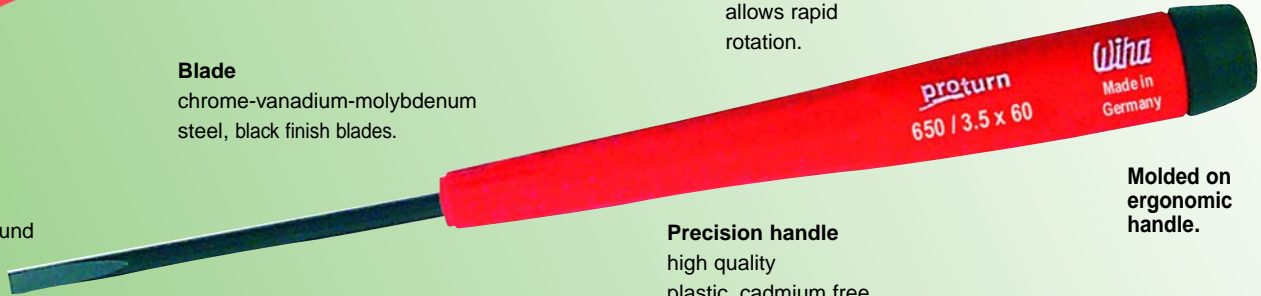

950 90 Set 6 Pcs. Slotted Protturn Precision

Molded on precision handle. Blade high alloy chrome-vanadium-molybdenum tool steel, black finish.

| Item No. | ↓ | ↔ | ↖ |
|----------|-----|----|---------|
| | mm | mm | lbs. |
| 950 90 | 1.5 | 40 | .27 |
| | 2.0 | 50 | |
| | 2.5 | 50 | |
| | 3.0 | 60 | |
| | 3.5 | 60 | Each |
| | 4.0 | 60 | \$18.50 |

951 90 Set 6 Pcs. Slotted/Phillips Protturn Precision

Molded on precision handle. Blade high alloy chrome-vanadium-molybdenum tool steel, black finish.

| Item No. | ↓ | ↔ | ↖ |
|----------|-----------------------|----|---------|
| | Size | mm | lbs. |
| 951 90 | Slotted: 1.5mm | 40 | .27 |
| | 2.5mm | 50 | |
| | 3.5mm | 60 | |
| | Phillips: 00 | 40 | |
| | 0 | 50 | Each |
| | 1 | 60 | \$18.98 |



Made in Germany

Toll Free: (800) 494-6104

Click image to view web page

Wiha Protturn Precision Series



953 92 Set 6 Pcs. Metric Hex Protturn Precision

Molded on precision handle. Blade high alloy chrome-vanadium-molybdenum tool steel, black finish.

| Item | | | |
|---------------|----------------|----|---------|
| No. | mm | mm | lbs. |
| 953 92 | Metric: | | |
| | 1.3 | 40 | .29 |
| | 1.5 | 50 | |
| | 2.0 | 50 | |
| | 2.5 | 60 | |
| | 3.0 | 60 | Each |
| | 4.0 | 60 | \$16.98 |



954 90 Set 8 Pcs. Inch Ball End Protturn Precision

Molded on precision handle. Blade high alloy chrome-vanadium-molybdenum tool steel, black finish.

| Item | | | |
|---------------|--------------|----|---------|
| No. | Inch | mm | lbs. |
| 954 90 | Inch: | | |
| | .050 | 40 | .39 |
| | 1/16 | 50 | |
| | 5/64 | 50 | |
| | 3/32 | 50 | |
| | 7/64 | 60 | |
| | 1/8 | 60 | |
| | 9/64 | 60 | Each |
| | 5/32 | 60 | \$28.98 |



953 91 Set 8 Pcs. Inch Hex Protturn Precision

Molded on precision handle. Blade high alloy chrome-vanadium-molybdenum tool steel, black finish.

| Item | | | |
|---------------|--------------|----|---------|
| No. | Inch | mm | lbs. |
| 953 91 | Inch: | | |
| | .050 | 40 | .29 |
| | 1/16 | 50 | |
| | 5/64 | 50 | |
| | 3/32 | 60 | |
| | 7/64 | 60 | |
| | 1/8 | 60 | |
| | 9/64 | 60 | Each |
| | 5/32 | 60 | \$23.98 |



668 50 1/4" Bit Holding Screwdriver, With Wiha-Protturn Precision

Magnetic, holds bit. Shaft chrome-vanadium-molybdenum steel, nickel-plated.

| Item | | | | | | | pkg. | Each |
|---------------|------|----|------|-----|------|------|------|--------|
| No. | Size | mm | Inch | mm | Inch | lbs. | | |
| 668 50 | 1/4" | 60 | 2.36 | 170 | 6.7 | .07 | 1 | \$6.80 |



968 00 Protturn Precision Chip Lifter

Molded on precision handle. Blade chrome-vanadium-molybdenum tool steel, hardened, black finish.

| Item | | | | | | | pkg. | Each |
|---------------|------|----|-----|------|------|---|------|--------|
| No. | Size | mm | mm | Inch | lbs. | | | |
| 968 00 | 1.0 | 50 | 145 | 5.71 | .07 | 1 | | \$4.88 |



Made in Germany

Wiha Protturn Precision Series



957 90 Set 6 Pcs. TORX® Protturn

Precision Molded on precision handle. Blade high alloy chrome-vanadium-molybdenum tool steel, black finish.

| Item No. | Size | mm | lbs. |
|----------|------|----|---------|
| 957 90 | T6 | 40 | .25 |
| | T7 | 40 | |
| | T8 | 40 | |
| | T9 | 50 | |
| | T10 | 50 | Each |
| | T15 | 60 | \$24.98 |



957 92 Set 7 Pcs. TORX® Cellular Repair Kit

Molded on precision handle. Blade high alloy chrome-vanadium-molybdenum tool steel, black finish.

| Item No. | Size | mm | lbs. |
|----------|------------------------------|----|---------|
| 957 92 | T3 | 40 | .25 |
| | T4 | 40 | |
| | T5 | 40 | |
| | T6 | 40 | |
| | T7 | 40 | Each |
| | T8 | 40 | \$28.98 |
| | Protturn lifter phone opener | | |



629 90 Slotted & Phillips Pocket Pack, 5 Pc. Set Wiha Protturn precision ball retainer handle & 4 Wiha interchangeable blades.

629 90 Set includes the following blades:

Slotted: 1.5, 2.0, 3.0, 4.0

Phillips: #000, #00, #0, #1

lbs. .15

Each

\$18.98

629 92 TORX® Pocket Pack, 5 Pc. Set Wiha Protturn precision ball retainer handle & 4 Wiha interchangeable blades.

629 92 Set includes the following blades:

TORX®: T6, T7, T8, T9, T10, T15, T20

lbs. .15

Each

\$19.98



629 93 Slotted/Phillips/TORX® Work Station, 9 Pc. Set Wiha Protturn precision ball retainer handle & 8 Wiha interchangeable blades.

629 93 Set includes the following blades:

Slotted: 1.5, 2.0, 3.0, 4.0

Phillips: #000, #00, #0, #1

TORX®: T6, T7, T8, T9, T10, T15, T20

lbs. .35

Each

\$35.98



629 95 Slotted/Phillips/TORX®/Ball End Hex Inch & Metric Tech Pack, 22 Pc. Set

Wiha Protturn precision ball retainer handle & 21 Wiha interchangeable blades. Set in canvas storage pouch.

629 95 Set includes the following blades:

Slotted: 1.5, 2.0, 3.0, 4.0

Phillips: #000, #00, #0, #1

TORX®: T6, T7, T8, T9, T10, T15, T20

Hex Inch: .050, 1/16, 5/64, 3/32, 7/64, 1/8, 9/64, 5/32"

Hex Metric: 1.5, 2.0, 2.5, 3.0, 4.0mm

lbs. .87

Each

\$52.70

629 94 Inch/Metric Ball End Hex Work Tech Pack, 14 Pc. Set Wiha Protturn precision ball retainer handle & 13 Wiha interchangeable blades.

629 94 Set includes the following blades:

Hex Inch: .050, 1/16, 5/64, 3/32, 7/64, 1/8, 9/64, 5/32"

Hex Metric: 1.5, 2.0, 2.5, 3.0, 4.0mm

lbs. .66

Set in canvas storage pouch.

Each

\$29.98



Made in Germany

Toll Free: (800) 494-6104

Click image to view web page



960 Slotted Screwdriver, With Precision Handle
Blade high alloy CVM steel. Single blister package.

| Item | ↕ | ↕ | ↕ | ↕ | ↕ | ↕ |
|--------|-----|------|----|------|------|--------|
| No. | mm | Inch | mm | lbs. | pkg. | Each |
| 960 15 | 1.5 | 1/16 | 40 | .05 | 1 | \$4.30 |
| 960 18 | 1.8 | .070 | 40 | .05 | 1 | \$4.20 |
| 960 20 | 2.0 | 5/64 | 40 | .05 | 1 | \$3.80 |
| 960 25 | 2.5 | 3/32 | 50 | .06 | 1 | \$3.80 |
| 960 30 | 3.0 | 1/8 | 50 | .06 | 1 | \$3.70 |
| 960 35 | 3.5 | 9/64 | 60 | .08 | 1 | \$4.10 |
| 960 40 | 4.0 | 5/32 | 60 | .08 | 1 | \$4.20 |



964 Ball End Hex Metric Precision Drivers
Blade high alloy chrome-vanadium-molybdenum steel. In single blister package.

| Item | ⬠ | ↕ | ↕ | ↕ | ↕ | ↕ |
|--------|------|----|------|------|--------|---|
| No. | Size | mm | lbs. | pkg. | Each | |
| 964 13 | 1.3 | 40 | .052 | 1 | \$4.50 | |
| 964 15 | 1.5 | 50 | .060 | 1 | \$4.40 | |
| 964 20 | 2.0 | 50 | .060 | 1 | \$4.40 | |
| 964 25 | 2.5 | 60 | .072 | 1 | \$4.40 | |
| 964 30 | 3.0 | 60 | .082 | 1 | \$4.50 | |



961 Phillips Screwdriver, with Precision Handle
Blade high alloy CVM steel. Single blister package.

| Item | ⊕ | ↕ | ↕ | ↕ | ↕ | ↕ |
|--------|------|----|------|------|--------|---|
| No. | Size | mm | lbs. | pkg. | Each | |
| 961 00 | 00 | 40 | .05 | 1 | \$4.40 | |
| 961 05 | 0 | 50 | .07 | 1 | \$4.30 | |
| 961 10 | 1 | 60 | .08 | 1 | \$4.20 | |



965 Nut Driver Metric Precision Drivers
Blade high alloy CVM steel. Single blister package.

| Item | ⊙ | ↕ | ↕ | ↕ | ↕ | ↕ |
|--------|------|----|------|------|--------|---|
| No. | Size | mm | lbs. | pkg. | Each | |
| 965 10 | 1.5 | 60 | .056 | 1 | \$4.70 | |
| 965 15 | 1.8 | 60 | .064 | 1 | \$4.70 | |
| 965 20 | 2.0 | 60 | .064 | 1 | \$4.90 | |
| 965 25 | 2.5 | 60 | .074 | 1 | \$4.90 | |
| 965 30 | 3.0 | 60 | .076 | 1 | \$5.00 | |
| 965 32 | 3.2 | 60 | .074 | 1 | \$5.10 | |
| 965 35 | 3.5 | 60 | .078 | 1 | \$5.10 | |
| 965 40 | 4.0 | 60 | .078 | 1 | \$5.30 | |
| 965 45 | 4.5 | 60 | .080 | 1 | \$5.30 | |
| 965 50 | 5.0 | 60 | .080 | 1 | \$5.30 | |
| 965 55 | 5.5 | 60 | .090 | 1 | \$5.50 | |
| 965 60 | 6.0 | 60 | .092 | 1 | \$5.50 | |
| 965 70 | 7.0 | 60 | .096 | 1 | \$5.60 | |



963 Hex Metric Screwdriver, Precision Handle
Blade high alloy CVM steel. Single blister package.

| Item | ⬠ | ↕ | ↕ | ↕ | ↕ | ↕ |
|--------|------|----|------|------|--------|---|
| No. | Size | mm | lbs. | pkg. | Each | |
| 963 07 | .71 | 40 | .052 | 1 | \$4.60 | |
| 963 09 | .89 | 40 | .052 | 1 | \$4.50 | |
| 963 13 | 1.3 | 40 | .054 | 1 | \$4.30 | |
| 963 15 | 1.5 | 50 | .060 | 1 | \$4.00 | |
| 963 20 | 2.0 | 50 | .058 | 1 | \$3.80 | |
| 963 25 | 2.5 | 60 | .070 | 1 | \$3.80 | |
| 963 30 | 3.0 | 60 | .070 | 1 | \$3.50 | |



965 Nut Driver Inch Precision Drivers
Blade high alloy CVM steel. Single blister package.

| Item | ⊙ | ↕ | ↕ | ↕ | ↕ | ↕ |
|--------|------|----|------|------|--------|---|
| No. | Size | mm | lbs. | pkg. | Each | |
| 965 23 | 3/32 | 60 | .072 | 1 | \$4.90 | |
| 965 27 | 7/64 | 60 | .076 | 1 | \$4.90 | |
| 965 31 | 1/8 | 60 | .074 | 1 | \$5.10 | |
| 965 36 | 9/64 | 60 | .076 | 1 | \$5.10 | |
| 965 39 | 5/32 | 60 | .076 | 1 | \$5.30 | |
| 965 47 | 3/16 | 60 | .080 | 1 | \$5.30 | |
| 965 56 | 7/32 | 60 | .088 | 1 | \$5.50 | |
| 965 63 | 1/4 | 60 | .096 | 1 | \$5.50 | |



963 Hex Inch Screwdriver, Precision Handle
Blade high alloy CVM steel. Single blister package.

| Item | ⬠ | ↕ | ↕ | ↕ | ↕ | ↕ |
|--------|------|----|------|------|--------|---|
| No. | Size | mm | lbs. | pkg. | Each | |
| 963 07 | .028 | 40 | .052 | 1 | \$4.60 | |
| 963 09 | .035 | 40 | .052 | 1 | \$4.50 | |
| 963 13 | .050 | 40 | .054 | 1 | \$4.30 | |
| 963 16 | 1/16 | 50 | .060 | 1 | \$4.00 | |
| 963 20 | 5/64 | 50 | .058 | 1 | \$3.80 | |
| 963 23 | 3/32 | 60 | .068 | 1 | \$3.80 | |
| 963 27 | 7/64 | 60 | .072 | 1 | \$3.60 | |
| 963 31 | 1/8 | 60 | .076 | 1 | \$3.50 | |



964 Ball End Hex Inch Precision Drivers
Blade high alloy chrome-vanadium-molybdenum steel. In single blister package.

| Item | ⬠ | ↕ | ↕ | ↕ | ↕ | ↕ |
|--------|------|----|-------|------|--------|---|
| No. | Size | mm | lbs. | pkg. | Each | |
| 964 13 | .050 | 40 | .052 | 1 | \$4.50 | |
| 964 16 | 1/16 | 50 | .060 | 1 | \$4.40 | |
| 964 19 | 5/64 | 50 | .060 | 1 | \$4.40 | |
| 964 23 | 3/32 | 50 | .062 | 1 | \$4.40 | |
| 964 27 | 7/64 | 60 | .082 | 1 | \$4.40 | |
| 964 31 | 1/8 | 60 | .082 | 1 | \$4.50 | |
| 964 36 | 9/64 | 60 | .078 | 1 | \$4.60 | |
| 964 39 | 5/32 | 60 | .0082 | 1 | \$4.70 | |



967 TORX® Screwdriver, With Precision handle
Blade high alloy chrome-vanadium-molybdenum steel. In single blister package.

| Item | ⚙ | ↕ | ↕ | ↕ | ↕ | ↕ |
|--------|------|----|------|------|--------|---|
| No. | Size | mm | lbs. | pkg. | Each | |
| 967 05 | T5 | 40 | .05 | 1 | \$5.20 | |
| 967 06 | T6 | 40 | .05 | 1 | \$5.20 | |
| 967 07 | T7 | 40 | .05 | 1 | \$5.20 | |
| 967 08 | T8 | 40 | .06 | 1 | \$5.20 | |
| 967 09 | T9 | 50 | .07 | 1 | \$5.30 | |
| 967 10 | T10 | 50 | .07 | 1 | \$5.50 | |
| 967 15 | T15 | 60 | .08 | 1 | \$5.60 | |
| 967 20 | T20 | 60 | .09 | 1 | \$5.70 | |



Made in Germany

www.wihatools.com

Click image to view web page

Wiha SYSTEM 4 Precision Handles and Blades

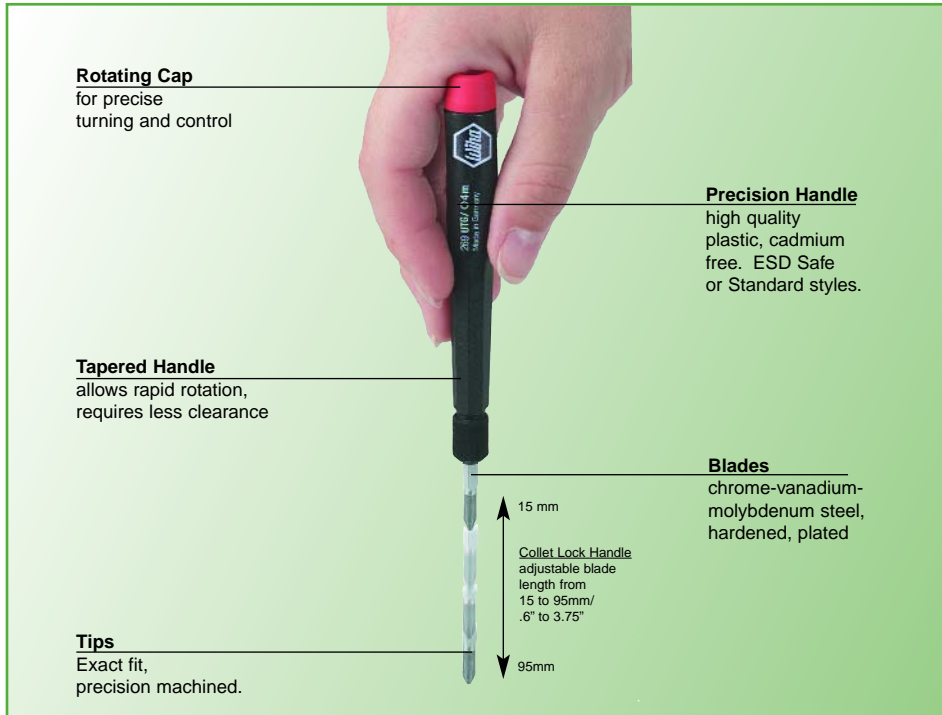

269 SYSTEM 4 Slotted Reversible Blade

High alloy chrome-vanadium-molybdenum steel, hardened, chrome-plated, Wiha vapor Chrome-Top finish on tips.

| Item | ↕ | ↕ | ↕ | ↕ | ↕ | ↕ |
|--------|-----------|-----|-----|------|------|--------|
| No. | mm | mm | mm | Inch | lbs. | Each |
| 269 03 | 1.5 + 3.0 | 120 | 4.7 | .03 | | \$7.60 |
| 269 04 | 2.0 + 3.5 | 120 | 4.7 | .03 | | \$7.30 |
| 269 05 | 2.5 + 4.0 | 120 | 4.7 | .04 | | \$7.00 |



269 SYSTEM 4 Phillips Reversible Blade

High alloy CVM steel, hardened, chrome-plated, Wiha vapor Chrome-Top finish on tips.

| Item | + | + | ↕ | ↕ | ↕ | ↕ |
|--------|----------|------|-----|------|------|--------|
| No. | Size | Size | mm | Inch | lbs. | Each |
| 269 11 | 000 + 00 | 120 | 4.7 | .03 | | \$7.00 |
| 269 12 | 0 + 1 | 120 | 4.7 | .03 | | \$6.10 |



269 00 SYS 4 Standard Precision Handle,

with rotating control cap. Accepts all SYSTEM 4 interchangeable blades. Wiha Precision handle, tapered, impact resistant. Ball retainer hold. 110mm/4.3" OAL

| Item | ↕ | ↕ | + | + | ↕ | ↕ |
|--------|-----|-------|------|------|------|--------|
| No. | mm | Inch | mm | Inch | lbs. | Each |
| 269 00 | 4.0 | .1574 | 14.0 | .55 | .04 | \$5.10 |



280 00 ESD Safe Conductive Precision Handle

with rotating control cap. Surface resistant 10⁶-10⁹ Ohms. 4 mm hex retainer for all SYSTEM 4 interchangeable blades. Tapered handle, high quality plastic, impact resistant. Ball retainer hold. 110mm/4.3" OAL

| Item | ↕ | ↕ | + | + | ↕ | ↕ |
|--------|-----|-------|------|------|------|--------|
| No. | mm | Inch | mm | Inch | lbs. | Each |
| 280 00 | 4.0 | .1574 | 14.0 | .55 | .04 | \$5.10 |



269 SYSTEM 4 Combined Slotted/Phillips Reversible Blade

High alloy CVM steel, hardened, chrome-plated, Wiha vapor Chrome-Top finish on tips.

| Item | ↕ | + | ↕ | ↕ | ↕ | ↕ |
|--------|------|------|-----|------|------|--------|
| No. | mm | Size | mm | Inch | lbs. | Each |
| 269 71 | 1.5+ | 000 | 120 | 4.7 | .03 | \$7.70 |
| 269 72 | 2.0+ | 00 | 120 | 4.7 | .03 | \$7.30 |
| 269 73 | 3.0+ | 0 | 120 | 4.7 | .03 | \$6.60 |
| 269 74 | 4.0+ | 1 | 120 | 4.7 | .04 | \$6.60 |



269 01 SYSTEM 4 Standard Precision Adjustable handle

with rotating control cap. Advantages:

- Allows adjustable blade from 15 to 95mm.
- Collet lock allows for quick & easy adjustment.
- Holds blade securely in place. Accepts all SYSTEM 4 blades. 110mm/4.3" OAL

| Item | ↕ | ↕ | + | + | ↕ | ↕ |
|--------|-----|-------|------|------|------|--------|
| No. | mm | Inch | mm | Inch | lbs. | Each |
| 269 01 | 4.0 | .1574 | 14.0 | .55 | .04 | \$5.90 |



280 01 ESD Safe Conductive Precision Adjustable Handle

with rotating control cap. Advantages:

- Use in ESD sensitive applications. Surface resistant 10⁶-10⁹ Ohms.
- Collet lock allows for quick & easy adjustment.
- Holds blade securely in place. Accepts all SYSTEM 4 blades. 110mm/4.3" OAL

| Item | ↕ | ↕ | + | + | ↕ | ↕ |
|--------|-----|-------|------|------|------|--------|
| No. | mm | Inch | mm | Inch | lbs. | Each |
| 280 01 | 4.0 | .1574 | 14.0 | .55 | .04 | \$5.90 |



269 SYSTEM 4 Pozidriv® Reversible Blade

High alloy chrome-vanadium-molybdenum steel, hardened, chrome-plated, Wiha vapor Chrome-Top finish on tips.

| Item | + | + | ↕ | ↕ | ↕ | ↕ |
|--------|-------|------|-----|------|------|--------|
| No. | Size | Size | mm | Inch | lbs. | Each |
| 269 22 | 0 + 1 | 120 | 4.7 | .03 | | \$6.20 |



Made in Germany

Toll Free: (800) 494-6104

Click image to view web page

Wiha SYSTEM 4 Precision Blades



269 SYSTEM 4 Metric Ball End & Standard Hex, Reversible Blade CVM steel, hardened, chrome-plated, Wiha vapor Chrome-Top finish on tips. One side hex, other side ballpoint hex.

| Item | | | | | |
|--------|-----------|---------|------|------|--------|
| No. | Size | Size mm | Inch | lbs. | Each |
| 269 32 | 1.3 + 1.3 | 120 | 4.7 | .05 | \$6.52 |
| 269 33 | 1.5 + 1.5 | 120 | 4.7 | .06 | \$6.52 |
| 269 34 | 2.0 + 2.0 | 120 | 4.7 | .06 | \$6.32 |
| 269 35 | 2.5 + 2.5 | 120 | 4.7 | .06 | \$6.12 |
| 269 36 | 3.0 + 3.0 | 120 | 4.7 | .06 | \$5.92 |
| 269 37 | 4.0 + 4.0 | 120 | 4.7 | .06 | \$5.92 |



280 SYSTEM 4 Metric Ball End Hex Interchangeable Blade High alloy tool steel, hardened, corrosion protected. Ballpoint end works at 30° angle entry for easy access to fasteners.

| Item | | | | | |
|--------|---------|------|------|------|----------|
| No. | Size mm | Inch | lbs. | pkg. | Each |
| 280 33 | 1.5 | 120 | 4.7 | .05 | 1 \$3.00 |
| 280 34 | 2.0 | 120 | 4.7 | .05 | 1 \$3.00 |
| 280 35 | 2.5 | 120 | 4.7 | .06 | 1 \$3.00 |
| 280 36 | 3.0 | 120 | 4.7 | .06 | 1 \$3.00 |
| 280 37 | 4.0 | 120 | 4.7 | .06 | 1 \$3.00 |



280 SYSTEM 4 Inch Ball End Hex Interchangeable Blade High alloy tool steel, hardened, corrosion protected. Ballpoint end works at 30° angle entry for easy access to fasteners.

| Item | | | | | |
|--------|------|-----|------|------|--------|
| No. | Size | mm | Inch | lbs. | Each |
| 280 21 | .050 | 120 | 4.7 | .06 | \$3.00 |
| 280 23 | 1/16 | 120 | 4.7 | .06 | \$3.00 |
| 280 24 | 5/64 | 120 | 4.7 | .06 | \$3.00 |
| 280 25 | 3/32 | 120 | 4.7 | .06 | \$3.00 |
| 280 26 | 7/64 | 120 | 4.7 | .06 | \$3.00 |
| 280 27 | 1/8 | 120 | 4.7 | .06 | \$3.00 |
| 280 28 | 9/64 | 120 | 4.7 | .06 | \$3.00 |
| 280 29 | 5/32 | 120 | 4.7 | .06 | \$3.00 |



269 SYSTEM 4 Metric Hex Sizes, Interchangeable Blade High alloy CVM steel, hardened, corrosion protected.

| Item | | | | | |
|--------|------|-----|------|------|--------|
| No. | Size | mm | Inch | lbs. | Each |
| 269 13 | 0.7 | 120 | 4.7 | .06 | \$3.68 |
| 269 14 | 0.9 | 120 | 4.7 | .06 | \$3.68 |
| 269 15 | 1.3 | 120 | 4.7 | .06 | \$3.50 |
| 269 16 | 1.5 | 120 | 4.7 | .06 | \$3.50 |
| 269 17 | 2.0 | 120 | 4.7 | .06 | \$3.50 |
| 269 18 | 2.5 | 120 | 4.7 | .06 | \$3.50 |
| 269 19 | 3.0 | 120 | 4.7 | .06 | \$3.08 |
| 269 20 | 4.0 | 120 | 4.7 | .06 | \$3.08 |



269 SYSTEM 4 Inch Hex Sizes, Interchangeable Blade High alloy chrome-vanadium-molybdenum steel, hardened, corrosion protected.

| Item | | | | | |
|--------|------|-----|------|------|--------|
| No. | Size | mm | Inch | lbs. | Each |
| 269 21 | .050 | 120 | 4.7 | .06 | \$4.10 |
| 269 23 | 1/16 | 120 | 4.7 | .06 | \$4.10 |
| 269 24 | 5/64 | 120 | 4.7 | .06 | \$3.90 |
| 269 25 | 3/32 | 120 | 4.7 | .06 | \$3.90 |
| 269 26 | 7/64 | 120 | 4.7 | .06 | \$3.90 |
| 269 27 | 1/8 | 120 | 4.7 | .06 | \$3.90 |
| 269 28 | 9/64 | 120 | 4.7 | .06 | \$3.50 |
| 269 29 | 5/32 | 120 | 4.7 | .06 | \$3.50 |



269 SYSTEM 4 Nut Driver Metric, Interchangeable Blade High alloy chrome-vanadium-molybdenum steel, hardened, corrosion protected. 120mm/4.7" OAL

| Item | | | | | | |
|--------|-----------|------|------|------|--------|------|
| No. | Size | Size | Inch | Inch | lbs. | Each |
| 269 40 | 1.5 + 1.8 | .12 | .12 | .03 | \$8.90 | |
| 269 41 | 2.0 + 2.5 | .16 | .16 | .03 | \$8.90 | |
| 269 38 | 1.5 - | .11 | .11 | .04 | \$5.40 | |
| 269 39 | 1.8 - | .12 | .12 | .04 | \$5.40 | |
| 269 49 | 2.0 - | .13 | .13 | .04 | \$5.40 | |
| 269 50 | 2.5 - | .16 | .16 | .04 | \$6.00 | |
| 269 42 | 3.0 - | .20 | .20 | .04 | \$6.20 | |
| 269 43 | 3.2 - | .20 | .20 | .04 | \$6.40 | |
| 269 44 | 3.5 - | .22 | .24 | .04 | \$6.40 | |
| 269 45 | 4.0 - | .22 | .24 | .04 | \$6.60 | |
| 269 46 | 4.5 - | .25 | .28 | .05 | \$6.60 | |
| 269 47 | 5.0 - | .27 | .28 | .05 | \$6.60 | |
| 269 48 | 5.5 - | .30 | .32 | .05 | \$6.90 | |



269 SYSTEM 4 Nut Driver Inch, Interchangeable Blade. High alloy chrome-vanadium-molybdenum steel, hardened, corrosion protected. 120mm/4.7" OAL

| Item | | | | | |
|--------|------|------|------|------|--------|
| No. | Size | Inch | Inch | lbs. | Each |
| 269 62 | 3/32 | .16 | .16 | .04 | \$5.40 |
| 269 63 | 7/64 | .20 | .20 | .04 | \$5.60 |
| 269 64 | 1/8 | .20 | .20 | .04 | \$5.90 |
| 269 65 | 9/64 | .21 | .24 | .04 | \$5.90 |
| 269 66 | 5/32 | .22 | .24 | .04 | \$5.90 |
| 269 67 | 3/16 | .26 | .28 | .04 | \$6.70 |
| 269 68 | 7/32 | .30 | .32 | .04 | \$6.70 |
| 269 69 | 1/4 | 1.34 | .36 | .04 | \$6.70 |



269 SYSTEM 4 TORX® Reversible Blade High alloy chrome-vanadium-molybdenum steel, hardened, vapor chrome protected, Wiha vapor Chrome-Top finish on tips. 120mm/4.7" OAL.

| Item | | | | |
|--------|-----------|------|--------|------|
| No. | Size | Size | lbs. | Each |
| 269 51 | T6 + T8 | .03 | \$5.60 | |
| 269 52 | T7 + T9 | .03 | \$5.60 | |
| 269 53 | T10 + T15 | .03 | \$5.60 | |
| 269 54 | T15 + T20 | .03 | \$5.60 | |



269 SYSTEM 4 TORX® Interchangeable Blade High alloy CVM steel, hardened, Wiha vapor Chrome-Top finish on tips. 120mm/4.7" OAL

| Item | | | |
|--------|------|------|--------|
| No. | Size | lbs. | Each |
| 269 55 | T3 | .03 | \$5.60 |
| 269 56 | T4 | .03 | \$5.60 |
| 269 57 | T5 | .03 | \$5.60 |



Made in Germany

www.wihatools.com

Click image to view web page

Wiha Canvas Pouch Sets



Canvas Pouch

269 90 Slotted & Phillips Precision Interchangeable Blade Set, 4 Pcs. Wiha ESD Safe precision collet lock handle and 3 Wiha interchangeable blades.
269 90 Set includes the following blades:
 † **Slotted Sizes:** 2.0, 3.0, 4.0mm
 † **Phillips Sizes:** 00, 0, 1 Each
 ⚖ **lbs.** .19 \$28.58

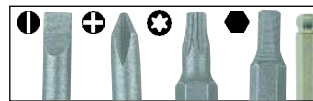

Canvas Pouch

280 80 Slotted, Phillips TORX® & Hex Precision Interchangeable Blade Set, 22 Pcs. Wiha ESD Safe precision collet lock handle and 20 Wiha interchangeable blades.
280 80 Set includes the following blades:
 † **Slotted Sizes:** 1.5, 2.0, 3.0, 4.0mm
 † **Phillips Sizes:** 000, 00, 0, 1
 † **Torx Sizes:** T3, T4, T5, T6, T7, T8, T9, T10, T15
 † **Hex Sizes:** .028, .035
 † **Ball Hex Sizes:** .050, 1/16, 5/64, 3/32, 7/64, 1/8, 9/64, 5/32"
Protturn Chip Lifter - #96800 Each
 ⚖ **lbs.** .33 \$81.60



Canvas Pouch

269 91 Slotted & Phillips Precision Interchangeable Blade Set, 6 Pcs. Wiha ESD Safe precision collet lock handle and 5 Wiha interchangeable blades. In canvas pouch.
269 91 Set includes the following blades:
 † **Slotted Sizes:** 1.5, 2.0, 2.5, 3.0, 3.5, 4.0mm
 † **Phillips Sizes:** 000, 00, 0, 1 Each
 ⚖ **lbs.** .29 \$43.98



**ESD Technicians Kit
Precision Screwdrivers & Tweezers**

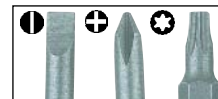

Canvas Pouch

445 90 Slotted, Phillips and TORX® Precision Interchangeable Blade Set, 12 Pcs. Wiha ESD Safe precision collet lock handle, 7 Wiha interchangeable blades and 4 ESD Safe Tweezers.
445 90 Set includes the following blades:
 † **Slotted Sizes:** 2.0, 3.0, 4.0mm
 † **Phillips Sizes:** 00, 0, 1
 † **Torx Sizes:** T6, T7, T8, T9, T10, T15
ESD Safe Precision Tweezers:
 44501 Fine Point - AA SA
 44509 Extra Fine Point - 5 SA
 44505 Flat and Blunt - 2a SA
 44510 Curved Fine Point - 7a SA Each
 ⚖ **lbs.** .60 \$99.98



Slotted, Phillips, Hex Set In Canvas Pouch

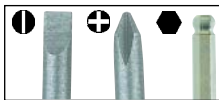

Canvas Pouch

269 92 Slotted, Phillips and Ball End Hex Metric/Inch Precision Interchangeable Blade Set, 17 Pcs. Wiha ESD Safe precision collet lock handle and 15 Wiha interchangeable blades.
269 92 Sets include the following blades:
 † **Slotted Sizes:** 1.5, 2.0, 3.0, 4.0mm
 † **Phillips Sizes:** 000, 00, 0, 1
 † **Ball End Hex Inch:** .050, 1/16, 5/64, 7/64, 3/32, 1/8"
 † **Ball End Hex Metric:** 1.5, 2.0, 2.5, 3.0, 4.0mm
Protturn Chip Lifter - #96800
 ⚖ **lbs.** .63 Each \$69.98





Made in Germany

Toll Free: (800) 494-6104

Click image to view web page

ESD Anti-Static Vinyl Pouch Set

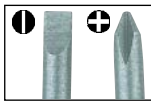

280 91 Slotted & Phillips Precision Interchangeable Blade Set, 6 Pcs. Wiha-ESD Safe precision collet lock handle and 5 Wiha interchangeable blades.

280 91 Set includes the following blades:
 ↓ **Slotted Sizes:** 1.5, 2.0, 2.5, 3.0, 3.5, 4.0mm
Phillips Sizes: 000, 00, 0, 1 **Each**
lbs. .25 **\$38.70**



TORX® Set



280 87 TORX® Precision Interchangeable Blade Set, 8 Pcs. Wiha-ESD Safe precision collet lock handle and 7 Wiha interchangeable blades.

280 87 Set includes the following blades:
TORX® Sizes on standard blades: T3, T4, T5
TORX® Sizes on reversible blades: T6, T7, T8, T9, T10, T15, T20
lbs. .31 **Each \$38.98**



Slotted, Phillips, TORX® Set



280 97 Slotted, Phillips and TORX® Precision Interchangeable Blade Set, 9 Pcs. Wiha ESD Safe precision collet lock handle and 8 Wiha interchangeable blades.

280 97 Set includes the following blades:
 ↓ **Slotted Sizes:** 1.5, 2.0, 3.0, 4.0mm
Phillips Sizes: 000, 00, 0, 1
Torx Sizes: T5, T6, T7, T8, T9, T10, T15
lbs. .33 **Each \$49.98**



Nut Driver Sets



280 88 Nut Driver Inch Precision Blade Set, 9 pcs. Wiha ESD Safe precision collet lock handle and 8 Wiha interchangeable blades.

280 88 Set includes the following blades:
Nut driver Inch Sizes: 3/32, 7/64, 1/8, 9/64, 5/32, 3/16, 7/32, 1/4"
lbs. .37 **Each \$49.60**



280 84 Slotted, Phillips and Ball End Hex Inch Precision Interchangeable Blade Set, 13 Pcs. Wiha ESD Safe precision collet lock handle and 12 Wiha interchangeable blades.

280 84 Set includes the following blades:
 ↓ **Slotted Sizes:** 1.5, 2.0, 3.0, 4.0mm
Phillips Sizes: 000, 00, 0, 1
Ball End Hex Inch Sizes: .050, 1/16, 5/64, 3/32, 7/64, 1/8, 9/64, 5/32"
lbs. .43 **Each \$44.98**



280 98 Nut Driver Metric Precision Blade Set, 8 Pcs. Wiha ESD Safe precision collet lock handle and 7 Wiha interchangeable blades.

280 98 Set includes the following blades:
Nut driver Metric Sizes: 3.0, 3.2, 3.5, 4.0, 4.5, 5.0, 5.5mm
lbs. .40 **Each \$47.98**



Slotted, Phillips, Torx® Set In Steel Box



280 94 Slotted, Phillips & Torx® Precision Interchangeable Blade Set, 11 Pcs. Wiha ESD Safe precision collet lock handle and 10 Wiha interchangeable blades.

280 94 Set includes the following blades:
 ↓ **Slotted Sizes:** 1.5, 2.0, 3.0, 4.0mm
Phillips Sizes: 000, 00, 0, 1
Torx®: T3, T4, T5, T6, T7, T8, T9, T10, T15
lbs. 1.51 **Each \$71.38**



Slotted & Phillips Set

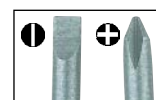

269 93 Slotted & Phillips Precision Interchangeable Blade Set, 6 Pcs. Wiha ESD Safe precision collet lock handle and 5 Wiha interchangeable blades.

269 93 Set includes the following blades:
 ↓ **Slotted Sizes:** 1.5, 2.0, 2.5, 3.0, 3.5, 4.0mm
Phillips Sizes: 000, 00, 0, 1 **Each**
lbs. .94 **\$49.98**





Wiha SYSTEM 4 Sets in Compact Fold-out box

Slotted, Phillips, TORX® Sets



269 96 Slotted & Phillips Precision Interchangeable Blade Set, 5 Pcs. Wiha ESD Safe precision collet lock handle and 4 Wiha interchangeable blades.

269 96 Set includes the following reversible blades in Slotted/Phillips sizes:

- Slotted Sizes: 1.5, 2.0, 3.0, 3.5mm
- ⊕ Phillips Sizes: 000, 00, 0, 1

lbs. .24 Each \$32.00



Nut Driver Sets



269 88 Nut Driver Inch Precision Blade Set, 9 Pcs. Wiha ESD Safe precision collet lock handle & 8 Wiha interchangeable blades.

269 88 Set includes the following blades:

● Nut driver Inch Sizes:

- 3/32, 7/64, 1/8, 9/64, 5/32,
- 3/16, 7/32, 1/4"

lbs. .38 Each \$49.60



269 97 Slotted, Phillips and TORX® Precision Interchangeable Blade Set, 9 Pcs. Wiha ESD Safe Precision Collet Lock handle and 8 Wiha Interchangeable blades.

269 97 Set includes the following blades:

- ↓ ● Slotted Sizes: 1.5, 2.0, 2.5, 3.0, 3.5, 4.0mm
- ⊕ Phillips Sizes: 000, 00, 0, 1
- ⊛ TORX® Sizes: T6, T7, T8, T9, T10, T15

lbs. .34 Each \$53.40



269 98 Nut Driver Metric Precision Blade Set, 9 Pcs. Wiha ESD Safe precision collet lock handle and 8 Wiha interchangeable blades.

269 98 Set includes the following blades:

● Nut driver Metric Sizes:

- 2.0, 2.5, 3.0, 3.2, 3.5, 4.0,
- 4.5, 5.0, 5.5mm

lbs. .40 Each \$58.98



TORX® Sets



269 99 Hex Metric Precision Blade Set, 9 Pcs. Wiha ESD Safe Precision Collet Lock handle and 8 Wiha interchangeable blades.

269 99 Set includes the following blades:

- ⬠ Hex Metric Sizes: 0.7, 0.9, 1.3, 1.5,
- 2.0, 2.5, 3.0, 4.0mm

lbs. .36 Each \$32.52



269 95 TORX® Precision Interchangeable Blade Set, 5 Pcs. Wiha ESD Safe precision collet lock handle & 4 interchangeable blades.

269 95 Set includes the following blades:

- ⊛ TORX® Sizes: T6, T7, T8, T9, T10, T15, T20

lbs. .24 Each \$25.90



269 89 Hex Inch Precision Blade Set, 9 Pcs. Wiha ESD Safe Precision Collet Lock handle and 8 Wiha interchangeable blades.

269 89 Set includes the following blades:

- ⬠ Hex Inch Sizes: .050, 1/16, 5/64, 3/32,
- 7/64, 1/8, 9/64, 5/32"

lbs. .35 Each \$32.52



269 87 TORX® Precision Interchangeable Blade Set, 8 Pcs. Wiha ESD Safe precision collet lock handle and 7 interchangeable blades.

269 87 Set includes the following blades:

⊛ TORX® Sizes on standard blades:

- T3, T4, T5

⊛ TORX® Sizes on reversible blades:

- T6, T7, T8, T9, T10, T15, T20

lbs. .33 Each \$38.76





Made in Germany

Toll Free: (800) 494-6104

Click image to view web page

Wiha SYSTEM 4 Micro Bits

SYSTEM 4 Handles and Micro Bits

Precision Handle
high quality plastic, cadmium free. ESD Safe or Standard Styles

Tapered Handle
allows rapid rotation, requires less clearance

Tips
Exact fit, precision machined

Rotating Cap
for precise turning and control

Collet Lock Handle
adjustable blade length from 15 to 95mm/.6" to 3.75"

Bits
chrome-vanadium-molybdenum steel, hardened, plated



753 SYSTEM 4 Hex Metric Bits High alloy CVM steel, hardened, on 4 mm hex stock.

| Item | Hex | mm | mm | Inch | lbs. | Each |
|--------|-----|-----|----|------|------|--------|
| 753 07 | | 0.7 | 28 | 1.1 | .007 | \$1.98 |
| 753 09 | | 0.9 | 28 | 1.1 | .007 | \$1.98 |
| 753 13 | | 1.3 | 28 | 1.1 | .007 | \$1.98 |
| 753 15 | | 1.5 | 28 | 1.1 | .007 | \$1.98 |
| 753 20 | | 2.0 | 28 | 1.1 | .007 | \$1.98 |
| 753 25 | | 2.5 | 28 | 1.1 | .007 | \$1.98 |
| 753 30 | | 3.0 | 28 | 1.1 | .007 | \$1.98 |
| 753 40 | | 4.0 | 28 | 1.1 | .007 | \$1.98 |



753 SYSTEM 4 Hex Inch Bits High alloy chrome-vanadium-molybdenum steel, hardened, on 4 mm hex stock.

| Item | Hex | Inch | mm | Inch | lbs. | Each |
|--------|-----|------|----|------|------|--------|
| 753 07 | | .028 | 28 | 1.1 | .007 | \$1.98 |
| 753 09 | | .035 | 28 | 1.1 | .007 | \$1.98 |
| 753 13 | | .050 | 28 | 1.1 | .007 | \$1.98 |
| 753 50 | | 1/16 | 28 | 1.1 | .007 | \$1.98 |
| 753 52 | | 5/64 | 28 | 1.1 | .007 | \$1.98 |
| 753 54 | | 3/32 | 28 | 1.1 | .007 | \$1.98 |
| 753 56 | | 7/64 | 28 | 1.1 | .007 | \$1.98 |
| 753 58 | | 1/8 | 28 | 1.1 | .007 | \$1.98 |
| 753 60 | | 9/64 | 28 | 1.1 | .007 | \$1.98 |
| 753 40 | | 5/32 | 28 | 1.1 | .007 | \$1.98 |



753 SYSTEM 4 Metric Tamper Resistant Hex Bits High alloy CVM steel, hardened, on 4 mm hex stock.

| Item | Hex | mm | mm | Inch | lbs. | Each |
|--------|-----|-----|----|------|------|--------|
| 753 22 | | 2.0 | 28 | 1.1 | .007 | \$2.20 |
| 753 27 | | 2.5 | 28 | 1.1 | .007 | \$2.20 |
| 753 32 | | 3.0 | 28 | 1.1 | .007 | \$2.20 |
| 753 42 | | 4.0 | 28 | 1.1 | .007 | \$2.20 |



753 SYSTEM 4 Tamper Resistant Hex Inch Bits High alloy CVM steel, hardened, on 4 mm hex stock.

| Item | Hex | Inch | mm | Inch | lbs. | Each |
|--------|-----|------|----|------|------|--------|
| 753 62 | | 5/64 | 28 | 1.1 | .007 | \$2.20 |
| 753 64 | | 3/32 | 28 | 1.1 | .007 | \$2.20 |
| 753 66 | | 7/64 | 28 | 1.1 | .007 | \$2.20 |
| 753 68 | | 1/8 | 28 | 1.1 | .007 | \$2.20 |
| 753 70 | | 9/64 | 28 | 1.1 | .007 | \$2.20 |
| 753 72 | | 5/32 | 28 | 1.1 | .007 | \$2.20 |



758 00 SYSTEM 4 Standard Precision Bit

Handle with rotating control cap. Wiha Precision handle, tapered, high quality plastic, impact resistant, ball retainer. Accepts all SYSTEM 4 Series bits. 110mm/4.3" OAL

| Item | Hex | mm | Inch | mm | Inch | lbs. | Each |
|--------|-----|-----|-------|------|------|------|--------|
| 758 00 | | 4.0 | .1574 | 14.0 | .55 | .06 | \$4.40 |



750 SYSTEM 4 Slotted Bits High alloy CVM steel, hardened, on 4 mm hex stock.

| Item | Hex | mm | mm | Inch | lbs. | Each |
|--------|-----|-----|----|------|------|--------|
| 750 08 | | 0.8 | 28 | 1.1 | .007 | \$1.98 |
| 750 12 | | 1.2 | 28 | 1.1 | .007 | \$1.98 |
| 750 15 | | 1.5 | 28 | 1.1 | .007 | \$1.98 |
| 750 18 | | 1.8 | 28 | 1.1 | .007 | \$1.98 |
| 750 20 | | 2.0 | 28 | 1.1 | .007 | \$1.98 |
| 750 25 | | 2.5 | 28 | 1.1 | .007 | \$1.98 |
| 750 30 | | 3.0 | 28 | 1.1 | .007 | \$1.98 |
| 750 35 | | 3.5 | 28 | 1.1 | .007 | \$1.98 |
| 750 40 | | 4.0 | 28 | 1.1 | .007 | \$1.98 |



758 01 SYSTEM 4 ESD Safe Conductive Precision Bit Handle

with rotating control cap. Wiha precision handle, tapered, high quality plastic, impact resistant.

Advantages:

- For working in ESD sensitive applications. Surface resistant 10⁶-10⁹ Ohms.
- Ball retainer holds bits securely in place.
- Accepts all SYSTEM 4 Series bits.
- 110mm/4.3" OAL

| Item | Hex | mm | Inch | mm | Inch | lbs. | Each |
|--------|-----|-----|-------|------|------|------|--------|
| 758 01 | | 4.0 | .1574 | 14.0 | .55 | .06 | \$4.40 |



751 SYSTEM 4 Phillips Bits

High alloy chrome-vanadium-molybdenum steel, hardened, on 4 mm hex stock.

| Item | Hex | Size | mm | Inch | lbs. | Each |
|--------|-----|------|----|------|------|--------|
| 751 05 | | 000 | 28 | 1.1 | .007 | \$1.98 |
| 751 10 | | 00 | 28 | 1.1 | .007 | \$1.98 |
| 751 15 | | 0 | 28 | 1.1 | .007 | \$1.98 |
| 751 20 | | 1 | 28 | 1.1 | .007 | \$1.98 |



Made in Germany

www.wihatools.com

Click image to view web page

Wiha SYSTEM 4 Micro Bits



757 SYSTEM 4 TORX® Bits

High alloy chrome-vanadium-molybdenum steel, hardened, on 4 mm stock.

| Item | | | | | |
|--------|------|----|------|------|--------|
| No. | Size | mm | Inch | lbs. | Each |
| 757 03 | T3 | 28 | 1.1 | .007 | \$1.98 |
| 757 04 | T4 | 28 | 1.1 | .007 | \$1.98 |
| 757 05 | T5 | 28 | 1.1 | .007 | \$1.98 |
| 757 06 | T6 | 28 | 1.1 | .007 | \$1.98 |
| 757 07 | T7 | 28 | 1.1 | .007 | \$1.98 |
| 757 08 | T8 | 28 | 1.1 | .007 | \$1.98 |
| 757 09 | T9 | 28 | 1.1 | .007 | \$1.98 |
| 757 10 | T10 | 28 | 1.1 | .007 | \$1.98 |
| 757 15 | T15 | 28 | 1.1 | .007 | \$1.98 |
| 757 20 | T20 | 28 | 1.1 | .007 | \$1.98 |



757 SYSTEM 4 TORX® Tamper Resistant Bits

High alloy CVM steel, hardened, on 4 mm stock.

| Item | | | | | |
|--------|------|----|------|------|--------|
| No. | Size | mm | Inch | lbs. | Each |
| 757 27 | TR7 | 28 | 1.1 | .007 | \$2.20 |
| 757 28 | TR8 | 28 | 1.1 | .007 | \$2.20 |
| 757 29 | TR9 | 28 | 1.1 | .007 | \$2.20 |
| 757 35 | TR10 | 28 | 1.1 | .007 | \$2.20 |
| 757 39 | TR15 | 28 | 1.1 | .007 | \$2.20 |
| 757 42 | TR20 | 28 | 1.1 | .007 | \$2.20 |



759 00 Extension blade for SYSTEM 4 Micro Bits.

Shaft CVM steel, hardened, corrosion protected. Ball retainer bit extension for 4 mm bits.

| Item | | | | | |
|--------|------|-----|-----|------|--------|
| No. | Size | mm | mm | lbs. | Each |
| 759 00 | 4.0 | 105 | 4.0 | .07 | \$5.10 |



759 01 Magnetic Bit extension blade for SYSTEM 4 Micro Bits.

Shaft Chrome-vanadium-molybdenum steel, hardened, corrosion protected. Magnetic bit holder.

| Item | | | | | |
|--------|------|-----|-----|------|--------|
| No. | Size | mm | mm | lbs. | Each |
| 759 01 | 4.0 | 105 | 4.0 | .04 | \$6.10 |

Wiha Micro Bits are Made in Germany or USA

759 99 SYSTEM 4 Slotted, Phillips, Hex Inch & Metric Precision Interchangeable Bit Set, 26 Pcs. In Compact Fold Out Box.

Wiha precision handle, bit extension & 24 interchangeable bits.

Item No. Combination Bit Set

759 99 Set with Standard Precision Handle

Sets include the following bits:

- Slotted: 1.5, 2.0, 3.0, 4.0mm
- Phillips: 000, 00, 0, 1
- Hex Metric: .7, .9, 1.3, 1.5, 2.0, 2.5, 3.0, 4.0mm
- Hex Inch: .050, 1/16, 5/64, 3/32, 7/64, 1/8, 9/64, 5/32"
- 105mm Bit Extension
- lbs. .34 Each \$46.68



26 Pc. Set

753 SYSTEM 4 Hex Inch & Metric Precision Interchangeable Bit Set, 18 Pcs. In Compact Fold Out Box.

Wiha precision handle, bit extension and 16 Wiha interchangeable bits.

Item No. Combination Bit Set

753 95 Set with Standard Precision Handle &

753 96 Set with ESD Safe Precision Handle

Sets include the following bits:

- Hex Metric: .7, .9, 1.3, 1.5, 2.0, 2.5, 3.0, 4.0mm
- Hex Inch: .050, 1/16, 5/64, 3/32, 7/64, 1/8, 9/64, 5/32"
- 105mm Bit Extension
- lbs. .31 Each \$31.98



18 Pc. Set

757 93 SYSTEM 4 TORX® & Hex Inch/ Metric Precision Interchangeable Bit Set, 26 Pcs. In Compact Fold Out Box.

Wiha standard precision handle, bit extension & 24 interchangeable bits.

Item No. Combination Bit Set

757 93 Set with Standard Precision Handle

Sets include the following bits:

- Hex Metric: .7, .9, 1.3, 1.5, 2.0, 2.5, 3.0, 4.0mm
- Hex Inch: .050, 1/16, 5/64, 3/32, 7/64, 1/8, 9/64, 5/32"
- TORX®: T4, T5, T6, T7, T8, T9, T10, T15
- 105mm Bit Extension
- lbs. .35 Each \$47.98



26 Pc. Set



Made in Germany

Toll Free: (800) 494-6104

Click image to view web page

Wiha SYS 4 Micro Bits & Compact Bit Sets

757 sets SYSTEM 4 **TORX®** Precision Interchangeable Bit Set, 11 Pcs. In Compact Fold Out Box. Sets include your choice of Wiha precision handle, bit extension and 9 Wiha interchangeable bits.

| Item No. | Handle Options for SYSTEM 4 |
|--|------------------------------------|
| 757 91 | Set with Standard Precision Handle |
| 757 92 | Set with ESD Safe Precision Handle |
| Sets include the following bits: | |
| <ul style="list-style-type: none"> TORX® Sizes: T3, T4, T5, T6, T7, T8, T9, T10, T15 105mm Bit Extension | |
| <ul style="list-style-type: none"> lbs. .26 Each \$27.50 | |



11 Pc. Set

759 sets SYSTEM 4 Slotted/Phillips/Hex Inch/**TORX®** Precision Interchangeable Bit Set, 27 Pcs. In Compact Fold Out Box. Sets include your choice of Wiha precision handle, bit extension and 25 Wiha interchangeable bits.

| Item No. | Handle Options for SYSTEM 4 |
|---|------------------------------------|
| 759 91 | Set with Standard Precision Handle |
| 759 92 | Set with ESD Safe Precision Handle |
| Sets include the following bits: | |
| <ul style="list-style-type: none"> Slotted Sizes: 1.5, 2.0, 3.0, 4.0mm Phillips Sizes: 000, 00, 0, 1 TORX® Sizes: T3, T4, T5, T6, T7, T8, T9, T10, T15 Hex Inch Sizes: .050, 1/16, 5/64, 3/32, 7/64, 1/8, 9/64, 5/32" 105mm Bit Extension | |
| <ul style="list-style-type: none"> lbs. .34 Each \$49.98 | |



27 Pc. Set

759 sets SYSTEM 4 Slotted/Phillips/Hex Metric/**TORX®** Precision Interchangeable Bit Set, 27 Pcs. In Compact Fold Out Box. Sets include your choice of Wiha precision handle, bit extension and 25 Wiha interchangeable bits.

| Item No. | Handle Options for SYSTEM 4 |
|---|------------------------------------|
| 759 93 | Set with Standard Precision Handle |
| 759 94 | Set with ESD Safe Precision Handle |
| Sets include the following bits: | |
| <ul style="list-style-type: none"> Slotted Sizes: 1.5, 2.0, 3.0, 4.0mm Phillips Sizes: 000, 00, 0, 1 TORX® Sizes: T3, T4, T5, T6, T7, T8, T9, T10, T15 Hex Metric Sizes: .7, .9, 1.3, 1.5, 2.0, 2.5, 3.0, 4.0mm 105mm Bit Extension | |
| <ul style="list-style-type: none"> lbs. .26 Each \$49.98 | |



27 Pc. Set

759 sets SYSTEM 4 Slotted/Phillips/Hex Metric/Hex Inch/**TORX®** Precision Interchangeable Bit Set, 40 Pcs. In Steel Box Case. Sets include your choice of Wiha precision handle, bit extension & 38 interchangeable bits.

| Item No. | Handle Options for SYSTEM 4 |
|--|------------------------------------|
| 759 95 | Set with Standard Precision Handle |
| 759 96 | Set with ESD Safe Precision Handle |
| Sets include the following bits: | |
| <ul style="list-style-type: none"> Slotted Sizes: 0.8, 1.2, 1.5, 1.8, 2.0, 2.5, 3.0, 3.5, 4.0mm Phillips Sizes: 000, 00, 0, 1 TORX® Sizes: T3, T4, T5, T6, T7, T8, T9, T10, T15 Hex Metric Sizes: .7, .9, 1.3, 1.5, 2.0, 2.5, 3.0, 4.0mm Hex Inch Sizes: .050, 1/16, 5/64, 3/32, 7/64, 1/8, 9/64, 5/32 105mm Bit Extension | |
| <ul style="list-style-type: none"> lbs. 1.04 Each \$79.98 | |

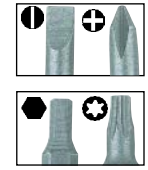

40 Pc. Set



SYSTEM 4 Micro Bit Sets

759 sets SYSTEM 4 Standard & Tamper Resistant Hex and **TORX®** and Tamper Resistant **TORX®** Precision Interchangeable Bit Set, 25 Pcs. In Compact Fold Out Box. Sets include your choice of Wiha precision handle, bit extension and 23 Wiha interchangeable bits.

| Item No. | Handle Options for SYSTEM 4 |
|---|------------------------------------|
| 759 97 | Set with Standard Precision Handle |
| 759 98 | Set with ESD Safe Precision Handle |
| Sets include the following bits: | |
| <ul style="list-style-type: none"> Standard Metric Hex: 1.5mm Tamper Resistant Metric Hex: 2.0, 2.5, 3.0, 4.0mm Standard Inch Hex: .050, 1/16" Tamper Resistant Inch Hex: 5/64, 3/32, 7/64, 1/8, 9/64, 5/32" Standard TORX® Sizes: T3, T4, T5, T6 Tamper Resistant TORX® Sizes: TR7, TR8, TR9, TR10, TR15, TR20 105mm Bit Extension | |
| <ul style="list-style-type: none"> lbs. .34 Each \$45.36 | |

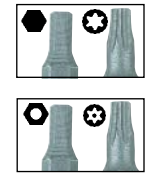

25 Pc. Set



Made in Germany

Toll Free: (800) 494-6104

Click image to view web page

Professional Quality ESD Tweezers

ESD SAFE • ANTI STATIC CONDUCTIVE • HYPO ALLERGENIC COATED • TEXTURED GRIPPING SURFACE

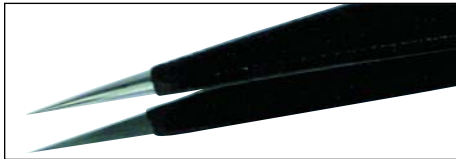

Universal Fine Point Tweezer

| Item No. | Description | wt. | Each |
|----------|-------------------|------|---------|
| 445 01 | AA SA ESD - 130mm | .088 | \$13.18 |

Anti-static conductive, ESD Safe hypo allergenic tweezers made from Vommeloy. Special stainless steel, anti-magnetic and acid resistant.

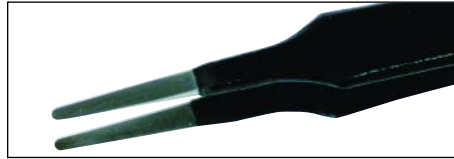

Flat Round Tip Smooth Sides

| Item No. | Description | wt. | Each |
|----------|-------------------|------|---------|
| 445 05 | 2a SA ESD - 120mm | .082 | \$16.60 |

Anti-static conductive, ESD Safe hypo allergenic tweezers made from Vommeloy. Special stainless steel, anti-magnetic and acid resistant.

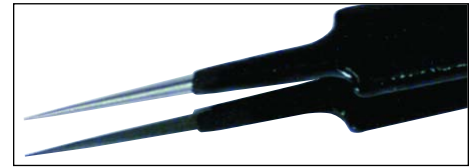

Extra Fine Points/Tapered To Tip

| Item No. | Description | wt. | Each |
|----------|------------------|------|---------|
| 445 09 | 5 SA ESD - 110mm | .076 | \$17.40 |

Anti-static conductive, ESD Safe hypo allergenic tweezers made from Vommeloy. Special stainless steel, anti-magnetic and acid resistant.

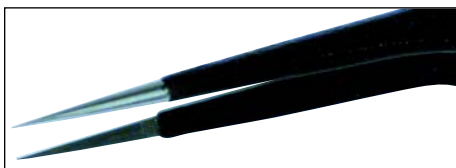

Sturdy Long, Fine Round Points

| Item No. | Description | wt. | Each |
|----------|-------------------|------|---------|
| 445 02 | GG SA ESD - 130mm | .092 | \$17.40 |

Anti-static conductive, ESD Safe hypo allergenic tweezers made from Vommeloy. Special stainless steel, anti-magnetic and acid resistant.

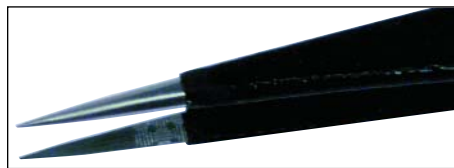

Fine Round Points For Assembly

| Item No. | Description | wt. | Each |
|----------|------------------|------|---------|
| 445 06 | 3 SA ESD - 120mm | .082 | \$16.88 |

Anti-static conductive, ESD Safe hypo allergenic tweezers made from Vommeloy. Special stainless steel, anti-magnetic and acid resistant.



Curved Extra Fine Rounded Tips

| Item No. | Description | wt. | Each |
|----------|-------------------|------|---------|
| 445 10 | 7a SA ESD - 120mm | .082 | \$21.80 |

Anti-static conductive, ESD Safe hypo allergenic tweezers made from Vommeloy. Special stainless steel, anti-magnetic and acid resistant.

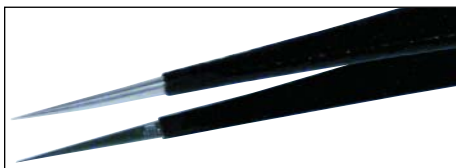

Long Narrow Body Low Force

| Item No. | Description | wt. | Each |
|----------|-------------------|------|---------|
| 445 03 | SS SA ESD - 135mm | .076 | \$16.88 |

Anti-static conductive, ESD Safe hypo allergenic tweezers made from Vommeloy. Special stainless steel, anti-magnetic and acid resistant.

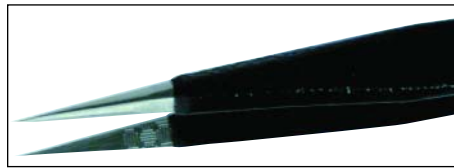

Fine Round Points Shorter

| Item No. | Description | wt. | Each |
|----------|-------------------|------|---------|
| 445 07 | 3c SA ESD - 110mm | .078 | \$16.88 |

Anti-static conductive, ESD Safe hypo allergenic tweezers made from Vommeloy. Special stainless steel, anti-magnetic and acid resistant.

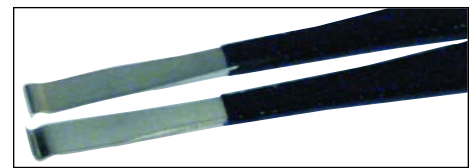

Holds 0.8 to 2mm Diameter

| Item No. | Description | wt. | Each |
|----------|-------------------|------|---------|
| 445 11 | 50 SA ESD - 120mm | .080 | \$17.50 |

Anti-static conductive, ESD Safe hypo allergenic tweezers made from Vommeloy. Special stainless steel, anti-magnetic and acid resistant.

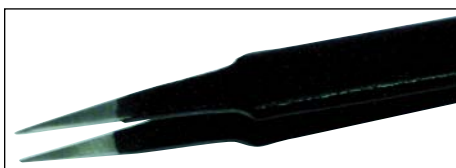

Reduced Body To Medium Point

| Item No. | Description | wt. | Each |
|----------|------------------|------|---------|
| 445 04 | 2 SA ESD - 120mm | .082 | \$15.82 |

Anti-static conductive, ESD Safe hypo allergenic tweezers made from Vommeloy. Special stainless steel, anti-magnetic and acid resistant.



Very Fine Points/Tapered To Tip

| Item No. | Description | wt. | Each |
|----------|------------------|------|---------|
| 445 08 | 4 SA ESD - 110mm | .080 | \$17.40 |

Anti-static conductive, ESD Safe hypo allergenic tweezers made from Vommeloy. Special stainless steel, anti-magnetic and acid resistant.

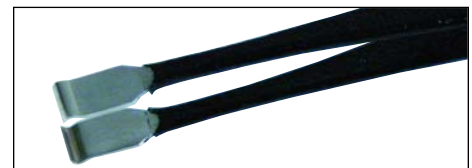

Holds 1.5 to 3mm Diameter

| Item No. | Description | wt. | Each |
|----------|-------------------|------|---------|
| 445 12 | 51 SA ESD - 120mm | .080 | \$17.50 |

Anti-static conductive, ESD Safe hypo allergenic tweezers made from Vommeloy. Special stainless steel, anti-magnetic and acid resistant.



Made in Germany

www.wihatools.com

Click image to view web page

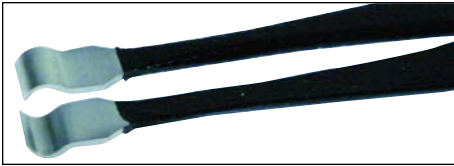

Holds 3.5 to 7mm Diameter

| Item No. | Description | wt. | Each |
|--|-------------------|------|---------|
| 445 13 | 52 SA ESD - 120mm | .082 | \$17.50 |
| Anti-static conductive, ESD Safe hypo allergenic tweezers made from Vommeloy. Special stainless steel, anti-magnetic and acid resistant. | | | |

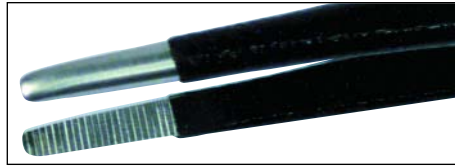

Universal Blunt Tip Serrated

| Item No. | Description | wt. | Each |
|--|-------------------|------|---------|
| 445 20 | 40 SA ESD - 145mm | .114 | \$17.30 |
| Anti-static conductive, ESD Safe hypo allergenic tweezers made from Vommeloy. Special stainless steel, anti-magnetic and acid resistant. | | | |

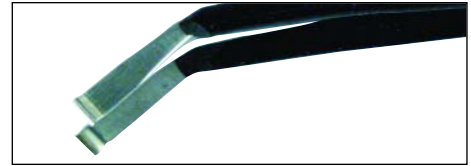

Flat Bent 35°, 3mm Diameter Grip

| Item No. | Description | wt. | Each |
|--|-----------------------|------|---------|
| 445 24 | 58 SA-SMD ESD - 117mm | .078 | \$18.90 |
| Anti-static conductive, ESD Safe hypo allergenic tweezers made from Vommeloy. Special stainless steel, anti-magnetic and acid resistant. | | | |



Holds 6.5 to 10mm Diameter

| Item No. | Description | wt. | Each |
|--|-------------------|------|---------|
| 445 14 | 53 SA ESD - 120mm | .082 | \$17.50 |
| Anti-static conductive, ESD Safe hypo allergenic tweezers made from Vommeloy. Special stainless steel, anti-magnetic and acid resistant. | | | |

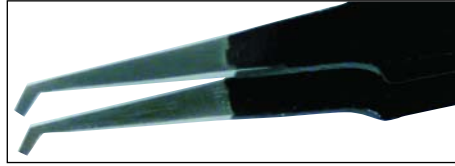

MicroTip 45° Hook 1x1x2mm

| Item No. | Description | wt. | Each |
|--|-----------------------|------|---------|
| 445 21 | 12 SA-SMD ESD - 120mm | .086 | \$21.20 |
| Anti-static conductive, ESD Safe hypo allergenic tweezers made from Vommeloy. Special stainless steel, anti-magnetic and acid resistant. | | | |



Curved Extra Fine, 3mm Long Straight Tip

| Item No. | Description | wt. | Each |
|--|---------------------|------|---------|
| 445 25 | 7abb SA ESD - 120mm | .082 | \$26.10 |
| Anti-static conductive, ESD Safe hypo allergenic tweezers made from Vommeloy. Special stainless steel, anti-magnetic and acid resistant. | | | |

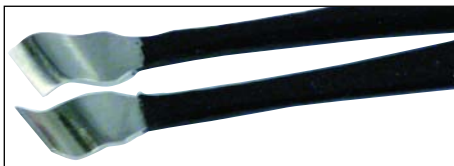

Angled 3.5 to 7mm Diameter

| Item No. | Description | wt. | Each |
|--|-------------------|------|---------|
| 445 15 | 54 SA ESD - 120mm | .080 | \$17.50 |
| Anti-static conductive, ESD Safe hypo allergenic tweezers made from Vommeloy. Special stainless steel, anti-magnetic and acid resistant. | | | |

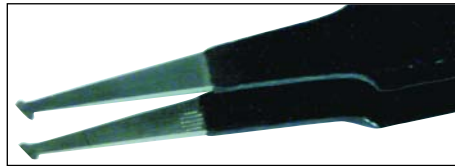

MicroTip For Chips Angled 1.6x1x1mm

| Item No. | Description | wt. | Each |
|--|-------------------|------|---------|
| 445 22 | 13 SA ESD - 120mm | .084 | \$21.20 |
| Anti-static conductive, ESD Safe hypo allergenic tweezers made from Vommeloy. Special stainless steel, anti-magnetic and acid resistant. | | | |

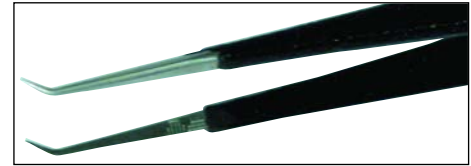

Narrow Body Low Force Bent 35°-3mm Tip

| Item No. | Description | wt. | Each |
|--|---------------------|------|---------|
| 445 26 | SSbb SA ESD - 140mm | .076 | \$21.40 |
| Anti-static conductive, ESD Safe hypo allergenic tweezers made from Vommeloy. Special stainless steel, anti-magnetic and acid resistant. | | | |



Narrow Rounded Tip Serrated, Guide Pin

| Item No. | Description | wt. | Each |
|--|-------------------|------|---------|
| 445 18 | 22 SA ESD - 150mm | .102 | \$17.50 |
| Anti-static conductive, ESD Safe hypo allergenic tweezers made from Vommeloy. Special stainless steel, anti-magnetic and acid resistant. | | | |

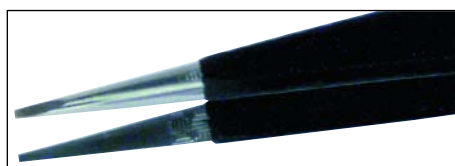

Long Rounded to 1.0mm Wide No Serration

| Item No. | Description | wt. | Each |
|--|--------------------|------|---------|
| 445 23 | PSF SA ESD - 125mm | .090 | \$16.20 |
| Anti-static conductive, ESD Safe hypo allergenic tweezers made from Vommeloy. Special stainless steel, anti-magnetic and acid resistant. | | | |



Angled Extra Fine Points Bent 30°, 3mm Long Tips

| Item No. | Description | wt. | Each |
|--|---------------------|------|---------|
| 445 27 | 5abb SA ESD - 117mm | .076 | \$22.10 |
| Anti-static conductive, ESD Safe hypo allergenic tweezers made from Vommeloy. Special stainless steel, anti-magnetic and acid resistant. | | | |



Made in Germany

Toll Free: (800) 494-6104

Click image to view web page



**Extra Fine Points Bent
30°, 3mm Long Tips**

| Item No. | Description | wt. | Each |
|----------|--------------------|------|---------|
| 445 28 | 5bb SA ESD - 107mm | .078 | \$20.90 |

Anti-static conductive, ESD Safe hypo allergenic tweezers made from Vommelloy. Special stainless steel, anti-magnetic and acid resistant.



**Heavy Duty Strong Tweezer
Tapered To Strong Point**

| Item No. | Description | wt. | Each |
|----------|-------------------|------|---------|
| 445 32 | 00 SA ESD - 120mm | .092 | \$22.10 |

Anti-static conductive, ESD Safe hypo allergenic tweezers made from Vommelloy. Special stainless steel, anti-magnetic and acid resistant.

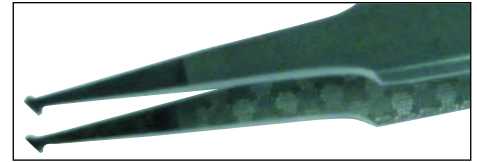

MicroTip 40° Hook 1.6x1x1mm Wide

| Item No. | Description | wt. | Each |
|----------|-------------------|------|---------|
| 466 13 | 13 SA SMD - 120mm | .082 | \$24.20 |

Stainless steel, anti-magnetic and acid resistant. Brushed finish tweezers made from Vommelloy.



**MicroTip Bent 30° 1mm
Wide 0.5mm Slot**

| Item No. | Description | wt. | Each |
|----------|-------------------|------|---------|
| 445 29 | 8b SA ESD - 120mm | .082 | \$23.10 |

Anti-static conductive, ESD Safe hypo allergenic tweezers made from Vommelloy. Special stainless steel, anti-magnetic and acid resistant.



**Angled & Slightly Bent
With Extra Fine Tips**

| Item No. | Description | wt. | Each |
|----------|------------------|------|---------|
| 445 33 | 7 SA ESD - 120mm | .082 | \$21.40 |

Anti-static conductive, ESD Safe hypo allergenic tweezers made from Vommelloy. Special stainless steel, anti-magnetic and acid resistant.



MicroTip Straight & 0.5mm Slot Milled

| Item No. | Description | wt. | Each |
|----------|-----------------|------|---------|
| 466 15 | 8SA SMD - 120mm | .082 | \$24.80 |

Stainless steel, anti-magnetic and acid resistant. Brushed finish tweezers made from Vommelloy.



**Flat Bent 35°, 2mm
Diameter Grip Radius**

| Item No. | Description | wt. | Each |
|----------|-----------------------|------|---------|
| 445 30 | 59 SA-SMD ESD - 117mm | .080 | \$18.90 |

Anti-static conductive, ESD Safe hypo allergenic tweezers made from Vommelloy. Special stainless steel, anti-magnetic and acid resistant.

Microscopy Tweezers



**MicroTip 30° Bend &
0.5mm Slot Milled**

| Item No. | Description | wt. | Each |
|----------|------------------|------|---------|
| 466 11 | 11SA ESD - 117mm | .082 | \$25.30 |

Stainless steel, anti-magnetic and acid resistant. Brushed finish tweezers made from Vommelloy.

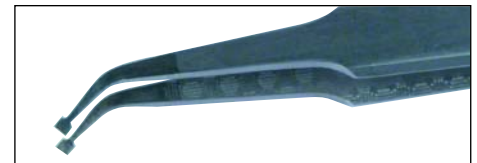

**MicroTip Bent 30° -
1mm Wide 0.5mm Slot**

| Item No. | Description | wt. | Each |
|----------|-------------------|------|---------|
| 466 16 | 8b SA SMD - 120mm | .082 | \$25.60 |

Stainless steel, anti-magnetic and acid resistant. Brushed finish tweezers made from Vommelloy.

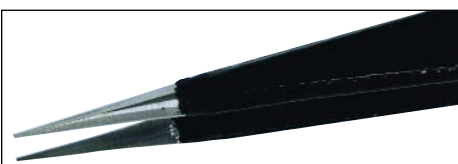

**ESD Safe General Purpose
Fine Point**

| Item No. | Description | wt. | Each |
|----------|------------------|------|---------|
| 445 31 | 1 SA ESD - 120mm | .084 | \$17.40 |

Anti-static conductive, ESD Safe hypo allergenic tweezers made from Vommelloy. Special stainless steel, anti-magnetic and acid resistant.



**MicroTip Straight, 0.5mm Slot,
Radius End**

| Item No. | Description | wt. | Each |
|----------|-------------------|------|---------|
| 466 17 | 8a SA SMD - 120mm | .080 | \$28.10 |

Stainless steel, anti-magnetic and acid resistant. Brushed finish tweezers made from Vommelloy.

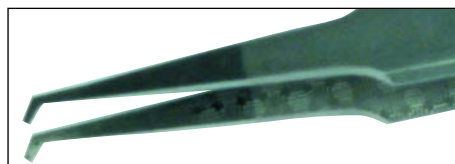

MicroTip 40° Hook 1x1x2mm Long

| Item No. | Description | wt. | Each |
|----------|------------------|------|---------|
| 466 12 | 12SA ESD - 120mm | .084 | \$24.20 |

Stainless steel, anti-magnetic and acid resistant. Brushed finish tweezers made from Vommelloy.



**MicroTip 30° Bent &
Angled With 0.5 Slot**

| Item No. | Description | wt. | Each |
|----------|-------------------|------|---------|
| 466 19 | 19 SA SMD - 120mm | .082 | \$26.20 |

Stainless steel, anti-magnetic and acid resistant. Brushed finish tweezers made from Vommelloy.



Made in Germany

www.wihatools.com

Click image to view web page

Professional Quality Tweezers

IN STANDARD AND SPECIAL SIZES



Blunt Tip, Serrated

| Item No. | Description | wt. | Each |
|----------|-------------|------|---------|
| 430 10 | 40 - 145mm | .106 | \$13.60 |

Carbon steel tweezers. Nickel-plated finish.

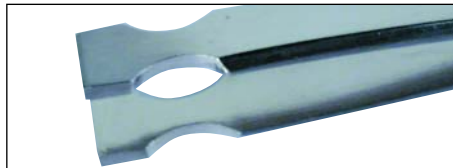

Forming Tweezer with Flush Ends

| Item No. | Description | wt. | Each |
|----------|-------------|------|---------|
| 438 02 | 8B - 100mm | .092 | \$18.90 |

Carbon steel tweezers. Nickel-plated finish.



Curved Extra Fine, 3mm Long Angled Tip

| Item No. | Description | wt. | Each |
|----------|-----------------|------|---------|
| 469 50 | 7abb SA - 120mm | .074 | \$28.90 |

Stainless steel, anti-magnetic and acid resistant.
Brushed finish tweezers made from Vomalloy.

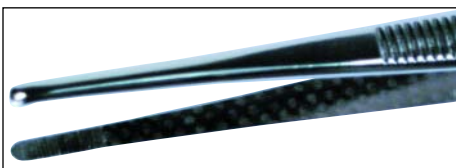

Blunt Tip Serrated

| Item No. | Description | wt. | Each |
|----------|---------------|------|---------|
| 430 14 | 40 SA - 145mm | .114 | \$18.40 |

Stainless steel, anti-magnetic and acid resistant.
Brushed finish tweezers made from Vomalloy.

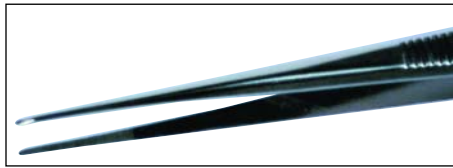

Long Tapered to Fine Tip Serrated

| Item No. | Description | wt. | Each |
|----------|-------------|------|---------|
| 450 10 | 30 - 145mm | .092 | \$13.60 |

Carbon steel tweezers. Nickel-plated finish.



Fine Points Angled with 40° - Tip Bend

| Item No. | Description | wt. | Each |
|----------|-----------------|------|---------|
| 469 70 | 5abb SA - 117mm | .070 | \$24.60 |

Stainless steel, anti-magnetic and acid resistant.
Brushed finish tweezers made from Vomalloy.

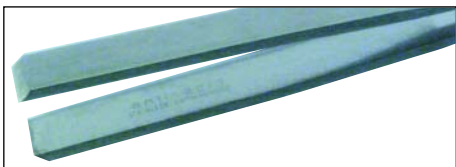

Heavy Duty Forming Tweezer

| Item No. | Description | wt. | Each |
|----------|--------------|------|---------|
| 438 00 | 8 SA - 120mm | .102 | \$21.50 |

Stainless steel, anti-magnetic and acid resistant.
Brushed finish tweezers made from Vomalloy.

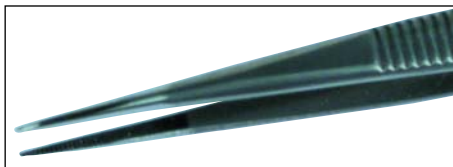

Tapered to Fine Tip Serrated

| Item No. | Description | wt. | Each |
|----------|---------------|------|---------|
| 452 10 | 34 SA - 120mm | .076 | \$17.80 |

Stainless steel, anti-magnetic and acid resistant.
Brushed finish tweezers made from Vomalloy.

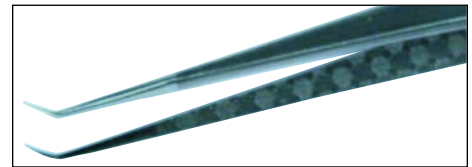

Narrow Body Low Force Bent 35° - 3mm Long Tip

| Item No. | Description | wt. | Each |
|----------|-----------------|------|---------|
| 469 71 | SSbb SA - 140mm | .072 | \$23.70 |

Stainless steel, anti-magnetic and acid resistant.
Brushed finish tweezers made from Vomalloy.

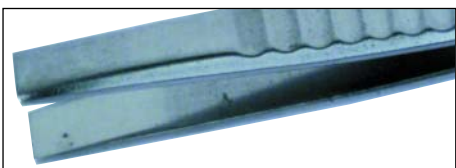

Forming Tweezers with Grip Panel

| Item No. | Description | wt. | Each |
|----------|-------------|------|---------|
| 438 01 | 8a - 100mm | .092 | \$18.70 |

Carbon steel tweezers. Nickel-plated finish.



Bent Fine Tip & Serrated

| Item No. | Description | wt. | Each |
|----------|----------------|------|---------|
| 452 11 | 34b SA - 120mm | .076 | \$18.90 |

Stainless steel, anti-magnetic and acid resistant.
Brushed finish tweezers made from Vomalloy.



Extra Fine Points Bent 30° 3mm Long Tip

| Item No. | Description | wt. | Each |
|----------|----------------|------|---------|
| 469 72 | 5bb SA - 107mm | .070 | \$23.60 |

Stainless steel, anti-magnetic and acid resistant.
Brushed finish tweezers made from Vomalloy.



Made in Germany

Toll Free: (800) 494-6104

Click image to view web page

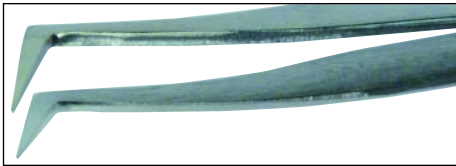

Fine Hooked & Tapered Tips

| Item No. | Description | wt. | Each |
|----------|--------------|------|---------|
| 469 87 | 6 SA - 120mm | .076 | \$24.50 |

Stainless steel, anti-magnetic and acid resistant.
Brushed finish tweezers made from Vommeloy.



Blunt 1mm Wide Tip Serrated

| Item No. | Description | wt. | Each |
|----------|-------------|------|---------|
| 491 85 | PSF - 125mm | .080 | \$13.70 |

Carbon steel tweezers. Nickel-plated finish.



Curved Extra Fine Tips

| Item No. | Description | wt. | Each |
|----------|---------------|------|---------|
| 493 76 | 7a SA - 120mm | .072 | \$24.80 |

Stainless steel, anti-magnetic and acid resistant.
Brushed finish tweezers made from Vommeloy.



Strong Tweezer Tapered To Point

| Item No. | Description | wt. | Each |
|----------|--------------|------|---------|
| 481 50 | OO S - 130mm | .076 | \$13.70 |

Stainless steel tweezers. Brushed finish.

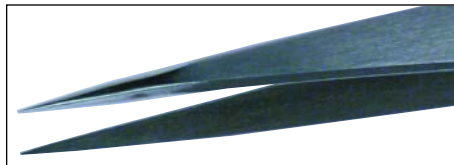

Universal Fine Points Tweezer

| Item No. | Description | wt. | Each |
|----------|--------------|------|---------|
| 492 84 | AA S - 130mm | .078 | \$14.10 |

Stainless steel tweezers. Natural finish.

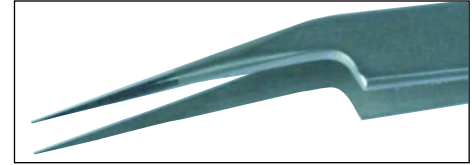

Fine Points Angled for Visibility

| Item No. | Description | wt. | Each |
|----------|---------------|------|---------|
| 493 77 | 5a SA - 110mm | .078 | \$21.50 |

Stainless steel, anti-magnetic and acid resistant.
Brushed finish tweezers made from Vommeloy.

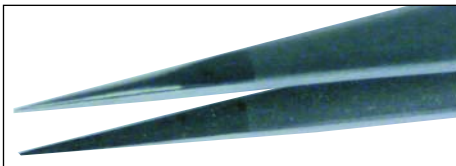

Heavy Duty Strong Tweezer Tapered To Strong Point

| Item No. | Description | wt. | Each |
|----------|---------------|------|---------|
| 487 00 | OO SA - 120mm | .084 | \$23.20 |

Stainless steel, anti-magnetic and acid resistant.
Brushed finish tweezers made from Vommeloy.



Flat Round Tip Bent 30° Smooth Sides

| Item No. | Description | wt. | Each |
|----------|----------------|------|---------|
| 493 68 | 2ab SA - 120mm | .078 | \$25.40 |

Stainless steel, anti-magnetic and acid resistant.
Brushed finish tweezers made from Vommeloy.

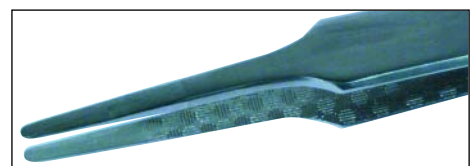

Flat Round Tip Smooth Sides

| Item No. | Description | wt. | Each |
|----------|---------------|------|---------|
| 493 78 | 2a SA - 120mm | .072 | \$20.40 |

Stainless steel, anti-magnetic and acid resistant.
Brushed finish tweezers made from Vommeloy.

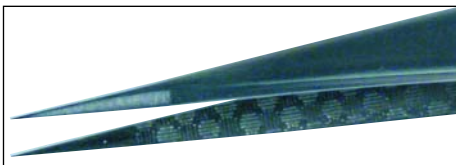

General Purpose Fine Points

| Item No. | Description | wt. | Each |
|----------|--------------|------|---------|
| 489 80 | 1 SA - 120mm | .076 | \$19.40 |

Stainless steel, anti-magnetic and acid resistant.
Brushed finish tweezers made from Vommeloy.

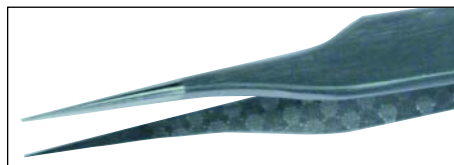

Angled Upward Extra Fine Tips

| Item No. | Description | wt. | Each |
|----------|--------------|------|---------|
| 493 75 | 7 SA - 120mm | .076 | \$22.50 |

Stainless steel, anti-magnetic and acid resistant.
Brushed finish tweezers made from Vommeloy.



Extra Fine Points & Tapered To Tip

| Item No. | Description | wt. | Each |
|----------|--------------|------|---------|
| 493 79 | 5 SA - 110mm | .074 | \$20.80 |

Stainless steel, anti-magnetic and acid resistant.
Brushed finish tweezers made from Vommeloy.



Universal Fine Points Tweezer

| Item No. | Description | wt. | Each |
|----------|-------------|------|---------|
| 491 84 | AA - 130mm | .080 | \$12.10 |

Carbon steel tweezers. Nickel-plated finish.



Made in Germany

www.wihatools.com

Click image to view web page



**Very Fine Points Bent 40°
Tapered To Tip**

| Item No. | Description | wt. | Each |
|---|---------------|------|---------|
| 493 80 | 4b SA - 110mm | .078 | \$21.80 |
| Stainless steel, anti-magnetic and acid resistant. Brushed finish tweezers made from Vommaloy. | | | |

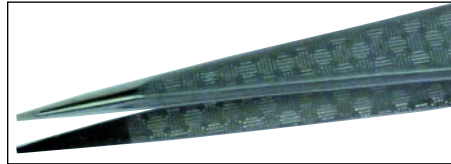

Blunt Tips - 1.0mm Wide Serrated

| Item No. | Description | wt. | Each |
|---|----------------|------|---------|
| 493 85 | PSF SA - 125mm | .086 | \$16.40 |
| Stainless steel, anti-magnetic and acid resistant. Brushed finish tweezers made from Vommaloy. | | | |



Bent Flat & Broad Tips 3mm Wide

| Item No. | Description | wt. | Each |
|---|---------------|------|---------|
| 496 40 | Fb SA - 120mm | .080 | \$24.50 |
| Stainless steel, anti-magnetic and acid resistant. Brushed finish tweezers made from Vommaloy. | | | |

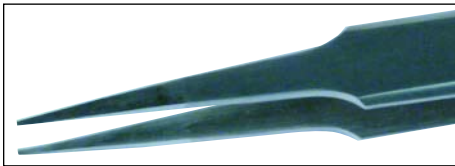

Reduced Body to Medium Point

| Item No. | Description | wt. | Each |
|---|--------------|------|---------|
| 493 81 | 2 SA - 120mm | .078 | \$20.60 |
| Stainless steel, anti-magnetic and acid resistant. Brushed finish tweezers made from Vommaloy. | | | |

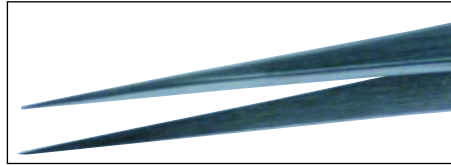

Long Narrow Body Low Force

| Item No. | Description | wt. | Each |
|---|---------------|------|---------|
| 493 87 | SS SA - 140mm | .074 | \$20.50 |
| Stainless steel, anti-magnetic and acid resistant. Brushed finish tweezers made from Vommaloy. | | | |



**Very Fine Round Points &
Tapered To Tip**

| Item No. | Description | wt. | Each |
|---|--------------|------|---------|
| 497 79 | 4 SA - 110mm | .076 | \$20.80 |
| Stainless steel, anti-magnetic and acid resistant. Brushed finish tweezers made from Vommaloy. | | | |



Flat and Broad Tips 3mm Wide

| Item No. | Description | wt. | Each |
|---|--------------|------|---------|
| 493 82 | F SA - 120mm | .076 | \$20.70 |
| Stainless steel, anti-magnetic and acid resistant. Brushed finish tweezers made from Vommaloy. | | | |



Strong, Long Tapered Fine Tips

| Item No. | Description | wt. | Each |
|---|---------------|------|---------|
| 493 88 | GG SA - 130mm | .090 | \$21.90 |
| Stainless steel, anti-magnetic and acid resistant. Brushed finish tweezers made from Vommaloy. | | | |



Fine Round Points Shorter

| Item No. | Description | wt. | Each |
|---|---------------|------|---------|
| 497 83 | 3c SA - 110mm | .078 | \$20.80 |
| Stainless steel, anti-magnetic and acid resistant. Brushed finish tweezers made from Vommaloy. | | | |

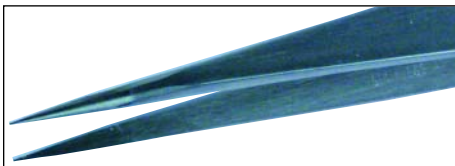

Fine Points for Assembly

| Item No. | Description | wt. | Each |
|---|--------------|------|---------|
| 493 83 | 3 SA - 120mm | .076 | \$20.70 |
| Stainless steel, anti-magnetic and acid resistant. Brushed finish tweezers made from Vommaloy. | | | |

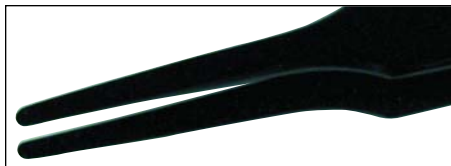

Flat Round Tip Smooth Sides

| Item No. | Description | wt. | Each |
|--|-----------------|------|---------|
| 494 78 | 2a SA T - 120mm | .080 | \$31.20 |
| Stainless steel, anti-magnetic and acid resistant. Teflon finish tweezers made from Vommaloy. | | | |

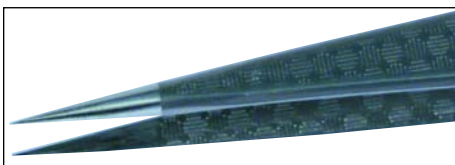

Universal Fine Points Tweezer

| Item No. | Description | wt. | Each |
|---|---------------|------|---------|
| 493 84 | AA SA - 130mm | .088 | \$15.00 |
| Stainless steel, anti-magnetic and acid resistant. Brushed finish tweezers made from Vommaloy. | | | |

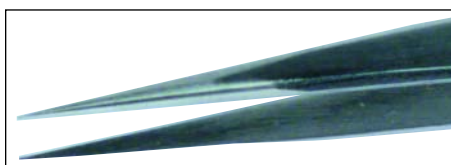

Longer Narrow Body Low Force

| Item No. | Description | wt. | Each |
|---|----------------|------|---------|
| 494 87 | SSL SA - 160mm | .096 | \$25.90 |
| Stainless steel, anti-magnetic and acid resistant. Brushed finish tweezers made from Vommaloy. | | | |



Very Fine Points Bent & Tapered Long

| Item No. | Description | wt. | Each |
|---|---------------|------|---------|
| 498 79 | 4L SA - 140mm | .082 | \$26.00 |
| Stainless steel, anti-magnetic and acid resistant. Brushed finish tweezers made from Vommaloy. | | | |



Made in Germany

Toll Free: (800) 494-6104

Click image to view web page

Professional Quality Wafer Tweezers



Back Stop, Top Is 2.4 Wide Bottom 7mm Wide, Teflon Coat

| Item No. | Description | wt. | Each |
|--|-----------------|------|---------|
| 437 31 | 37 SA T - 120mm | .076 | \$48.10 |
| Stainless steel, anti-magnetic and acid resistant. Teflon PTFE finish tweezers. | | | |

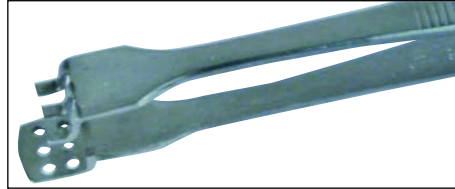

9mm Wide With Back Stop Pins

| Item No. | Description | wt. | Each |
|---|---------------|------|---------|
| 439 48 | 89 SA - 125mm | .080 | \$28.40 |
| Stainless steel, anti-magnetic and acid resistant. Brushed finish tweezers made from Vommaloy. | | | |



16mm Limit Access & Back Stop

| Item No. | Description | wt. | Each |
|---|----------------|------|---------|
| 450 39 | 150 SA - 125mm | .096 | \$45.20 |
| Stainless steel, anti-magnetic and acid resistant. Brushed finish tweezers made from Vommaloy. | | | |



12mm Wide Teflon Pivot Pad

| Item No. | Description | wt. | Each |
|---|---------------|------|---------|
| 437 79 | 77 SA - 125mm | .084 | \$44.90 |
| Stainless steel, anti-magnetic and acid resistant. Brushed finish tweezers made from Vommaloy. | | | |



12mm Wide With Back Stop Pins

| Item No. | Description | wt. | Each |
|---|----------------|------|---------|
| 439 49 | 89a SA - 125mm | .080 | \$27.90 |
| Stainless steel, anti-magnetic and acid resistant. Brushed finish tweezers made from Vommaloy. | | | |

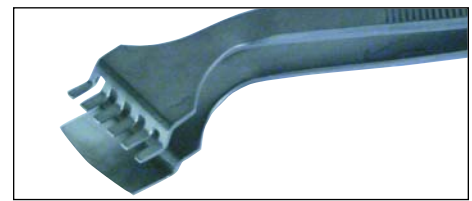

Bent Large 20mm Wide, Back Stop

| Item No. | Description | wt. | Each |
|---|---------------|------|---------|
| 460 69 | 61 SA - 125mm | .108 | \$43.80 |
| Stainless steel, anti-magnetic and acid resistant. Brushed finish tweezers made from Vommaloy. | | | |

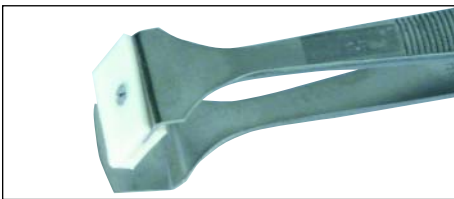

20mm Teflon Pivot Pad

| Item No. | Description | wt. | Each |
|---|---------------|------|---------|
| 437 80 | 79 SA - 125mm | .112 | \$55.50 |
| Stainless steel, anti-magnetic and acid resistant. Brushed finish tweezers made from Vommaloy. | | | |



Angled 4 Pin 12mm Wide

| Item No. | Description | wt. | Each |
|--|---------------|------|---------|
| 441 49 | 16 SA - 125mm | .080 | \$27.70 |
| Stainless steel, anti-magnetic and acid resistant. Wafer tweezers made from Vommaloy. | | | |



Small Narrow 3mm Blunt Point

| Item No. | Description | wt. | Each |
|---|----------------|------|---------|
| 472 99 | 72a SA - 115mm | .076 | \$27.20 |
| Stainless steel, anti-magnetic and acid resistant. Brushed finish tweezers made from Vommaloy. | | | |

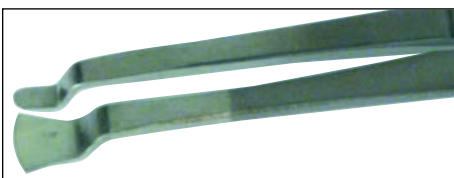

Back Stop, Top 2.4 Bottom 7mm

| Item No. | Description | wt. | Each |
|---|---------------|------|---------|
| 437 99 | 37 SA - 120mm | .076 | \$37.50 |
| Stainless steel, anti-magnetic and acid resistant. Brushed finish tweezers made from Vommaloy. | | | |



16mm Wide With Back Stop

| Item No. | Description | wt. | Each |
|---|---------------|------|---------|
| 441 59 | 49 SA - 125mm | .094 | \$29.00 |
| Stainless steel, anti-magnetic and acid resistant. Brushed finish tweezers made from Vommaloy. | | | |

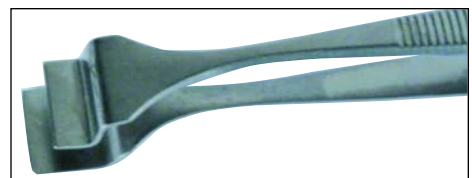

Angled 12mm Wide Flat, Back Stop

| Item No. | Description | wt. | Each |
|---|---------------|------|---------|
| 476 00 | 91 SA - 125mm | .080 | \$26.80 |
| Stainless steel, anti-magnetic and acid resistant. Brushed finish tweezers made from Vommaloy. | | | |



Made in Germany

www.wihatools.com

Click image to view web page

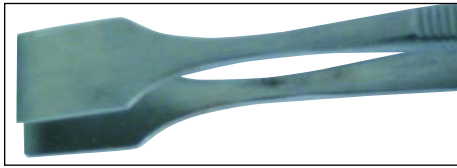

Flat Straight 12mm Wide

| Item No. | Description | wt. | Each |
|--|---------------|------|---------|
| 477 15 | 36 SA - 125mm | .082 | \$20.90 |
| Stainless steel, anti-magnetic and acid resistant. Brushed finish tweezers made from Vommelloy. | | | |

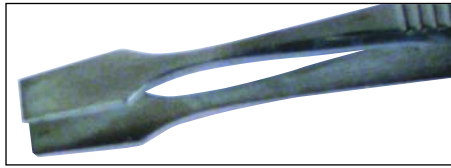

Flat Straight Narrow 5mm Wide

| Item No. | Description | wt. | Each |
|--|---------------|------|---------|
| 495 85 | 38 SA - 105mm | .076 | \$19.70 |
| Stainless steel, anti-magnetic and acid resistant. Brushed finish tweezers made from Vommelloy. | | | |

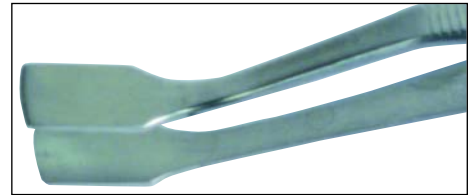

Flat Angled 8mm Wide

| Item No. | Description | wt. | Each |
|--|----------------|------|---------|
| 496 20 | 27a SA - 125mm | .080 | \$29.50 |
| Stainless steel, anti-magnetic and acid resistant. Brushed finish tweezers made from Vommelloy. | | | |

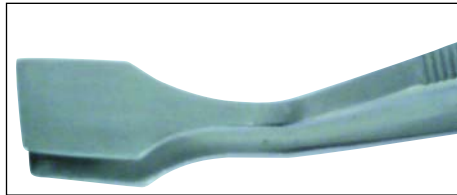

Flat Angled 12mm Wide

| Item No. | Description | wt. | Each |
|--|----------------|------|---------|
| 477 16 | 36a SA - 125mm | .084 | \$22.40 |
| Stainless steel, anti-magnetic and acid resistant. Brushed finish tweezers made from Vommelloy. | | | |

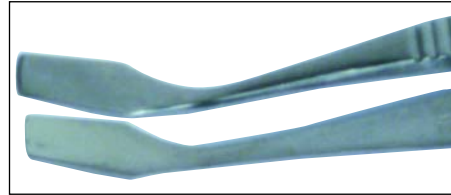

Flat Angled 5mm Wide

| Item No. | Description | wt. | Each |
|--|----------------|------|---------|
| 495 87 | 38a SA - 103mm | .078 | \$21.30 |
| Stainless steel, anti-magnetic and acid resistant. Brushed finish tweezers made from Vommelloy. | | | |

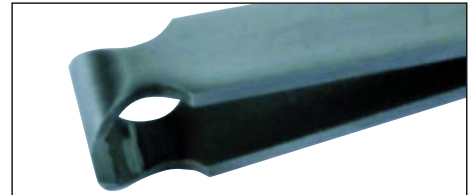

End Cutting Tweezer

| Item No. | Description | wt. | Each |
|--------------------------------|-------------|------|---------|
| 465 00 | D - 95mm | .106 | \$23.40 |
| Carbon steel. UnPlated finish. | | | |

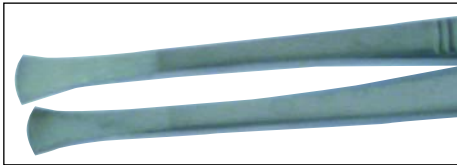

Half Round Thin 7mm Wide

| Item No. | Description | wt. | Each |
|--|----------------|------|---------|
| 479 82 | 35a SA - 120mm | .076 | \$21.00 |
| Stainless steel, anti-magnetic and acid resistant. Brushed finish tweezers made from Vommelloy. | | | |

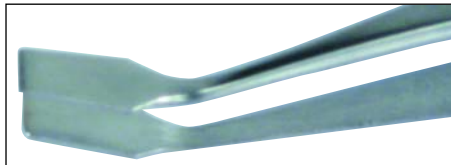

Long Angled 5mm Wide

| Item No. | Description | wt. | Each |
|--|----------------|------|---------|
| 495 88 | 39a SA - 123mm | .080 | \$22.40 |
| Stainless steel, anti-magnetic and acid resistant. Brushed finish tweezers made from Vommelloy. | | | |



Curved Very Fine Cutting Tweezer

| Item No. | Description | wt. | Each |
|---|-------------|------|---------|
| 483 07 | C7 - 115mm | .082 | \$69.90 |
| Carbon steel made from Vommelloy. Brushed finish. | | | |



Long Flat Straight 5mm Wide

| Item No. | Description | wt. | Each |
|--|---------------|------|---------|
| 495 84 | 39 SA - 125mm | .078 | \$20.60 |
| Stainless steel, anti-magnetic and acid resistant. Brushed finish tweezers made from Vommelloy. | | | |

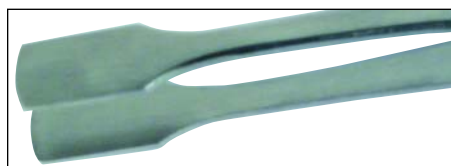

Flat Straight 8mm Wide

| Item No. | Description | wt. | Each |
|--|---------------|------|---------|
| 496 00 | 27 SA - 125mm | .080 | \$21.50 |
| Stainless steel, anti-magnetic and acid resistant. Brushed finish tweezers made from Vommelloy. | | | |

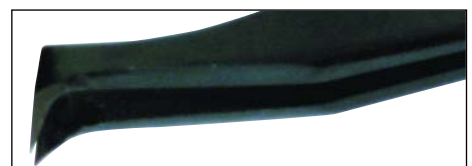

Angled Head, Cutting Nippers

| Item No. | Description | wt. | Each |
|-------------------------------|--------------|------|---------|
| 495 01 | 1 5a - 115mm | .106 | \$68.40 |
| Carbon steel. Natural finish. | | | |



Made in Germany

Toll Free: (800) 494-6104

Click image to view web page

Professional Quality Guide Pins Tweezers

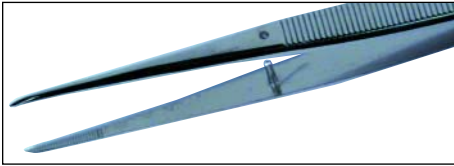

Fine Tip Straight, Guide Pin, Fine Serrated

| Item No. | Description | wt. | Each |
|----------|---|------|---------|
| 420 12 | 17 - 120mm Carbon steel. Nickel-plated finish. | .078 | \$13.60 |

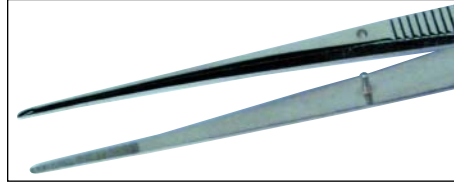

Long Straight, Guide Pin, Fine Serrated

| Item No. | Description | wt. | Each |
|----------|---|------|---------|
| 450 12 | 31 - 145mm Carbon steel. Nickel-plated finish. | .096 | \$16.00 |

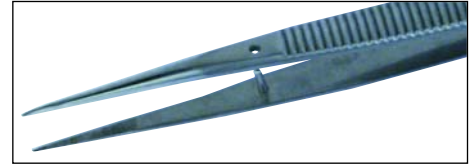

Universal Straight Guide Pin, Fine Serrated

| Item No. | Description | wt. | Each |
|----------|--|------|---------|
| 452 12 | 35 SA - 120mm Stainless steel, anti-magnetic and acid resistant. Brushed Finish tweezers made from Vommeloy. | .078 | \$20.00 |

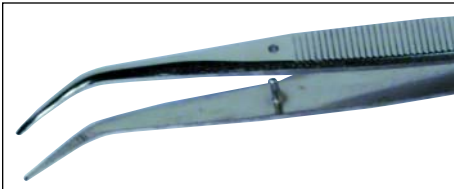

Fine Tip Bent, Guide Pin, Fine Serrated

| Item No. | Description | wt. | Each |
|----------|--|------|---------|
| 420 13 | 17B - 120mm Carbon steel. Nickel-plated finish. | .078 | \$16.20 |



Long Bent, Guide Pin, Serrated

| Item No. | Description | wt. | Each |
|----------|--|------|---------|
| 450 13 | 31b - 145mm Carbon steel. Nickel-plated finish. | .092 | \$20.00 |



Fine Bent, Guide Pin, Serrated

| Item No. | Description | wt. | Each |
|----------|---|------|---------|
| 452 13 | 35B SA - 145mm Stainless steel, anti-magnetic and acid resistant. Brushed Finish tweezers made from Vommeloy. | .078 | \$21.80 |

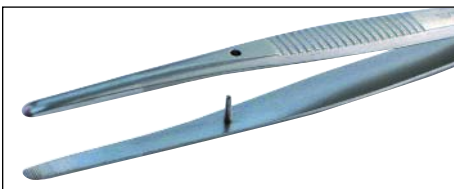

Blunt Tip Straight, Guide Pin, Serrated

| Item No. | Description | wt. | Each |
|----------|--|------|---------|
| 432 12 | 45 SA - 120mm Stainless steel, anti-magnetic and acid resistant. Brushed Finish tweezers made from Vommeloy. | .088 | \$19.50 |

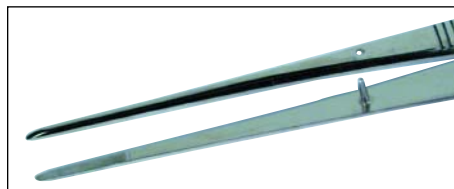

Longer Straight, Guide Pin, Fine Serrated

| Item No. | Description | wt. | Each |
|----------|---|------|---------|
| 451 12 | 33 - 165mm Carbon steel. Nickel-plated finish. | .102 | \$20.50 |

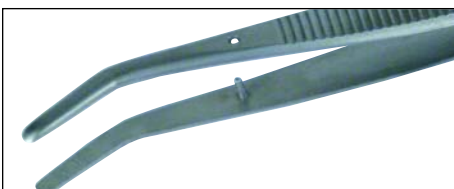

Heavy, Blunt, Straight, Guide Pin, Serrated Tweezer

| Item No. | Description | wt. | Each |
|----------|---|------|---------|
| 432 13 | 45b SA - 120mm Stainless steel, anti-magnetic and acid resistant. Brushed Finish tweezers made from Vommeloy. | .088 | \$20.70 |



Bent, Long, Guide Pin, Fine Serrated Tweezer

| Item No. | Description | wt. | Each |
|----------|--|------|---------|
| 451 13 | 33b - 165mm Carbon steel. Nickel-plated finish. | .102 | \$21.60 |

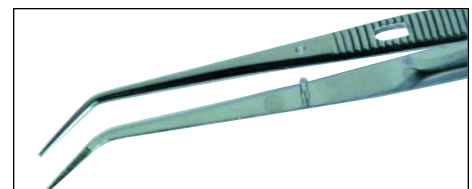

Long Pointed, Angled Tip, Guide Pin & Lock

| Item No. | Description | wt. | Each |
|----------|--|------|---------|
| 491 50 | 20S - 150mm Stainless steel. Polished finish. | .096 | \$39.90 |



Made in Germany

www.wihatools.com

Click image to view web page

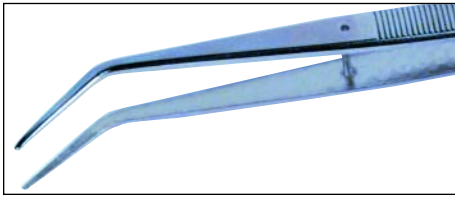

Narrow Body, Bent, Long, Guide Pin, Serrated Tweezer

| Item No. | Description | wt. | Each |
|----------|-------------|------|---------|
| 491 53 | 22b - 155mm | .096 | \$15.40 |

Carbon steel. Nickel-plated finish.

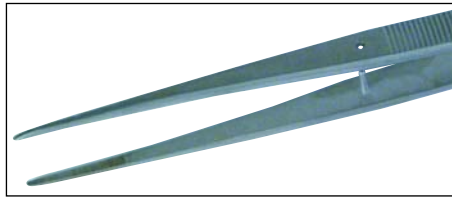

Narrow Body, Straight, Long, Guide Pin, Serrated Tweezer

| Item No. | Description | wt. | Each |
|----------|---------------|------|---------|
| 491 59 | 22 SA - 155mm | .102 | \$19.70 |

Stainless steel, anti-magnetic and acid resistant.
Brushed Finish tweezers made from Vommeloy.

Long Tweezers With Cross Tips

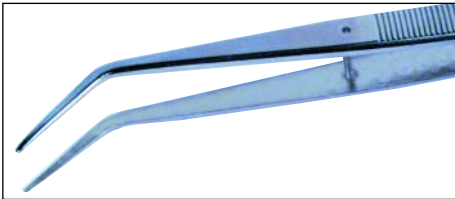

Narrow Body, Bent, Long, Guide Pin, Serrated Tweezer

| Item No. | Description | wt. | Each |
|----------|---------------|------|---------|
| 491 54 | 22b S - 155mm | .094 | \$18.10 |

Stainless steel. Natural finish.

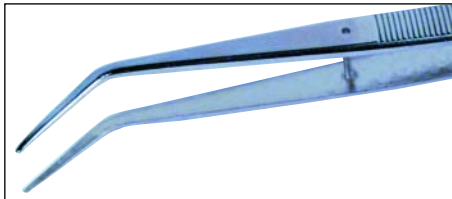

Narrow Body, Bent, Long, Guide Pin, Serrated Tweezer

| Item No. | Description | wt. | Each |
|----------|----------------|------|---------|
| 491 60 | 22b SA - 155mm | .102 | \$19.70 |

Stainless steel, anti-magnetic and acid resistant.
Brushed Finish tweezers made from Vommeloy.



Rounded Tip Long With Grip Pattern

| Item No. | Description | wt. | Each |
|----------|----------------|------|---------|
| 497 09 | D13 SA - 160mm | .098 | \$21.70 |

Stainless steel, anti-magnetic and acid resistant.
Brushed Finish tweezers made from Vommeloy.

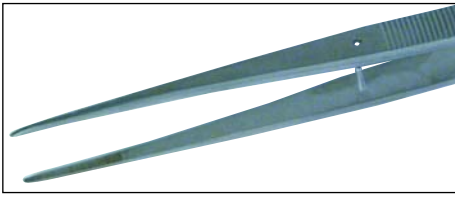

Narrow Body, Straight, Long, Guide Pin, Serrated Tweezer

| Item No. | Description | wt. | Each |
|----------|-------------|------|---------|
| 491 55 | 22 - 155mm | .094 | \$14.90 |

Carbon steel. Nickel-plated finish.

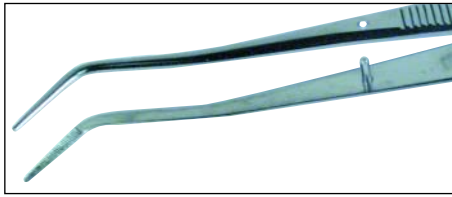

Narrow Body, Bent & Angled, Long, Guide Pin, Serrated

| Item No. | Description | wt. | Each |
|----------|--------------|------|---------|
| 491 61 | 24 S - 155mm | .092 | \$24.90 |

Stainless steel. Natural finish.

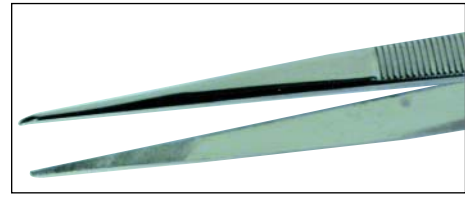

Rounded Tip Long with Grip Pattern

| Item No. | Description | wt. | Each |
|----------|-------------|------|---------|
| 497 14 | D13 - 160mm | .096 | \$19.00 |

Carbon steel. Nickel-plated finish.

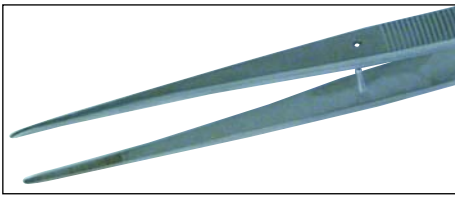

Narrow Body, Straight, Long, Guide Pin, Serrated Tweezer

| Item No. | Description | wt. | Each |
|----------|--------------|------|---------|
| 491 56 | 22 S - 155mm | .094 | \$17.00 |

Stainless steel. Natural finish.

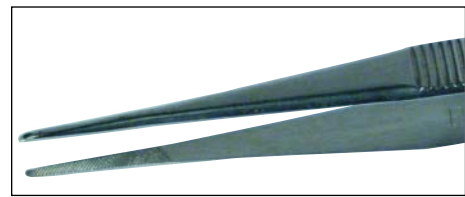

Rounded Tip Long With Grip Pattern

| Item No. | Description | wt. | Each |
|----------|---------------|------|---------|
| 497 16 | D13 S - 160mm | .094 | \$20.20 |

Stainless steel. Natural finish.



Made in Germany

Toll Free: (800) 494-6104

Click image to view web page

Professional Quality SMD

COMPONENT POSITIONING & DESOLDERING TWEEZERS



Holds 0.8 to 2.0 Diameter

| Item No. | Description | wt. | Each |
|---|---------------|------|---------|
| 421 41 | 50 SA - 120mm | .078 | \$20.10 |
| Stainless steel, anti-magnetic and acid resistant. Brushed Finish tweezers made from Vomalloy. | | | |

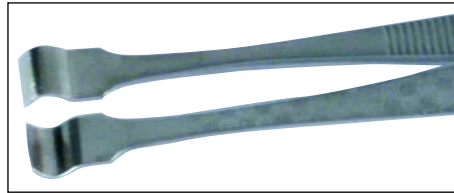

Holds 3.5 to 7mm Diameter

| Item No. | Description | wt. | Each |
|---|---------------|------|---------|
| 421 49 | 52 SA - 120mm | .078 | \$20.10 |
| Stainless steel, anti-magnetic and acid resistant. Brushed Finish tweezers made from Vomalloy. | | | |

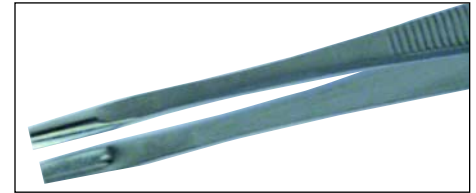

Vertical 1.5 to 3.5mm Diameter

| Item No. | Description | wt. | Each |
|---|---------------|------|---------|
| 421 55 | 55 SA - 120mm | .078 | \$20.10 |
| Stainless steel, anti-magnetic and acid resistant. Brushed Finish tweezers made from Vomalloy. | | | |

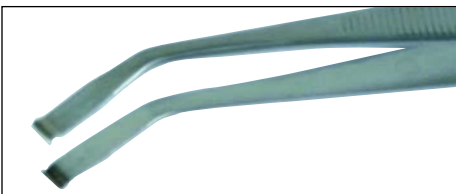

Flat Bent 35° 3mm Dia. Milled Slot

| Item No. | Description | wt. | Each |
|---|-------------------|------|---------|
| 421 42 | 58 SA SMD - 117mm | .076 | \$21.60 |
| Stainless steel, anti-magnetic and acid resistant. Brushed Finish tweezers made from Vomalloy. | | | |

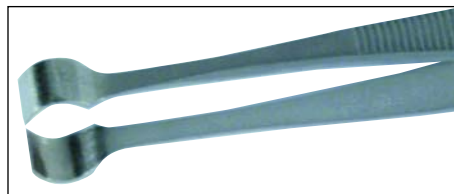

Holds 6.5 to 10mm Diameter

| Item No. | Description | wt. | Each |
|---|---------------|------|---------|
| 421 50 | 53 SA - 120mm | .076 | \$20.10 |
| Stainless steel, anti-magnetic and acid resistant. Brushed Finish tweezers made from Vomalloy. | | | |

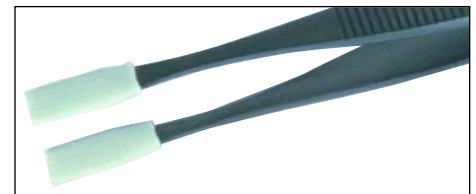

**Silicon Covered Flat
Long 5mm Wide**

| Item No. | Description | wt. | Each |
|---|---------------|------|---------|
| 434 13 | 68 SA - 145mm | .104 | \$30.40 |
| Stainless steel, anti-magnetic and acid resistant. Brushed Finish tweezers made from Vomalloy. | | | |

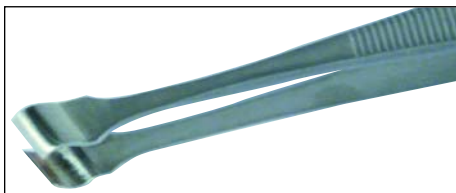

Angled 3.5 to 7mm Diameter

| Item No. | Description | wt. | Each |
|---|---------------|------|---------|
| 421 46 | 54 SA - 120mm | .080 | \$20.10 |
| Stainless steel, anti-magnetic and acid resistant. Brushed Finish tweezers made from Vomalloy. | | | |

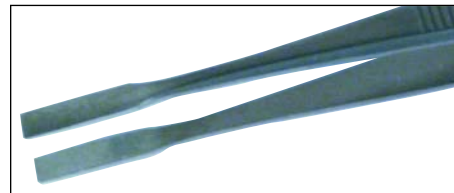

Flat Straight 3mm Diameter

| Item No. | Description | wt. | Each |
|---|---------------|------|---------|
| 421 51 | 56 SA - 120mm | .078 | \$20.10 |
| Stainless steel, anti-magnetic and acid resistant. Brushed Finish tweezers made from Vomalloy. | | | |

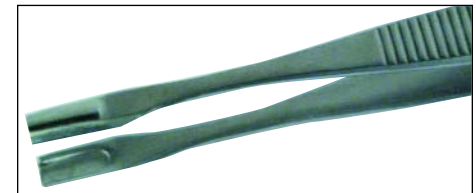

**Vertical Long, Holds
2.5 to 5mm Diameter**

| Item No. | Description | wt. | Each |
|---|---------------|------|---------|
| 434 14 | 64 SA - 145mm | .102 | \$23.50 |
| Stainless steel, anti-magnetic and acid resistant. Brushed Finish tweezers made from Vomalloy. | | | |



Holds 1.5 to 3.0 Diameter

| Item No. | Description | wt. | Each |
|---|---------------|------|---------|
| 421 48 | 51 SA - 120mm | .078 | \$20.10 |
| Stainless steel, anti-magnetic and acid resistant. Brushed Finish tweezers made from Vomalloy. | | | |

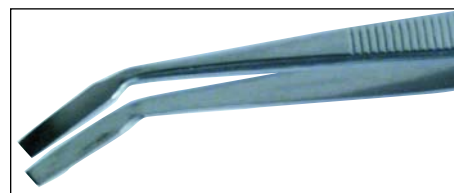

Flat Bent 35° 3mm Diameter

| Item No. | Description | wt. | Each |
|---|---------------|------|---------|
| 421 52 | 57 SA - 120mm | .078 | \$20.80 |
| Stainless steel, anti-magnetic and acid resistant. Brushed Finish tweezers made from Vomalloy. | | | |

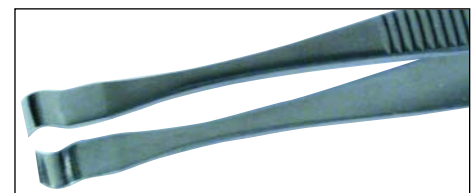

Long, Holds 3.5 to 7mm Diameter

| Item No. | Description | wt. | Each |
|---|---------------|------|---------|
| 434 16 | 62 SA - 145mm | .108 | \$23.50 |
| Stainless steel, anti-magnetic and acid resistant. Brushed Finish tweezers made from Vomalloy. | | | |



Made in Germany



Long Bent at Tips 5mm Wide

| Item No. | Description | wt. | Each |
|----------|---------------|------|---------|
| 434 17 | 67 SA - 145mm | .104 | \$23.40 |

Stainless steel, anti-magnetic and acid resistant.
Brushed Finish tweezers made from Vommeloy.

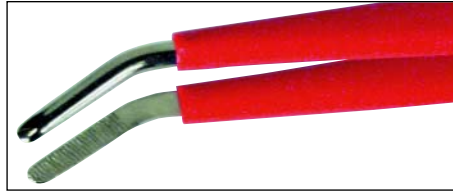

Blunt End Bent Isolated & Serrated

| Item No. | Description | wt. | Each |
|----------|------------------|------|---------|
| 430 16 | 40b isol - 145mm | .122 | \$15.50 |

Carbon steel. Nickel-plated finish.

**Super Thin
Foil Tweezers**

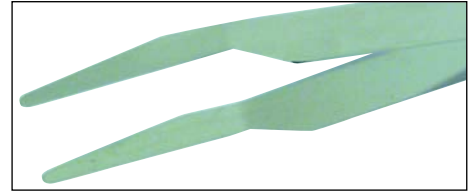

Blunt, Thin .035", Very Low Force

| Item No. | Description | wt. | Each |
|----------|----------------|------|---------|
| 492 15 | 112 SA - 100mm | .052 | \$25.90 |

Stainless steel, anti-magnetic and acid resistant.
Polished finish tweezers made from Vommeloy.

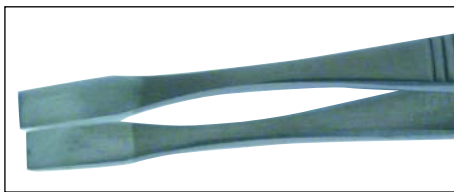

Flat Long & Straight 5mm Wide

| Item No. | Description | wt. | Each |
|----------|---------------|------|---------|
| 434 18 | 66 SA - 145mm | .102 | \$23.40 |

Stainless steel, anti-magnetic and acid resistant.
Brushed Finish tweezers made from Vommeloy.

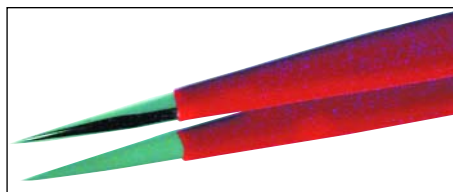

Universal Pointed Tip Isolated

| Item No. | Description | wt. | Each |
|----------|-----------------|------|---------|
| 481 00 | AA isol - 130mm | .096 | \$17.20 |

Carbon steel. Nickel-plated finish.

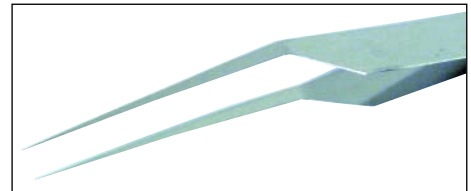

Pointed, Thin .035", Very Low Force

| Item No. | Description | wt. | Each |
|----------|----------------|------|---------|
| 492 20 | 113 SA - 100mm | .052 | \$26.30 |

Stainless steel, anti-magnetic and acid resistant.
Polished finish tweezers made from Vommeloy.

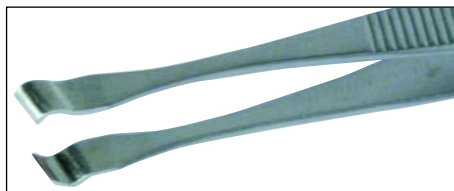

**Bent Long, Holds 3.5 to
7mm Diameter**

| Item No. | Description | wt. | Each |
|----------|---------------|------|---------|
| 434 19 | 63 SA - 145mm | .102 | \$23.40 |

Stainless steel, anti-magnetic and acid resistant.
Brushed Finish tweezers made from Vommeloy.

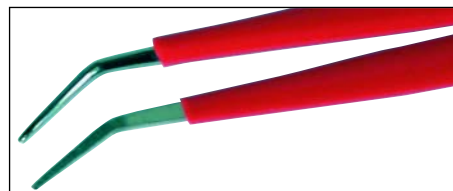

**Narrow Pointed, Bent,
Isolated Serrated**

| Item No. | Description | wt. | Each |
|----------|------------------|------|---------|
| 491 57 | 22b isol - 145mm | .104 | \$16.70 |

Carbon steel. Nickel-plated finish.

**Self Closing
Tweezers**



Long Straight Tweezer

| Item No. | Description | wt. | Each |
|----------|---------------|------|---------|
| 432 70 | R29 S - 160mm | .114 | \$23.70 |

Stainless steel, anti-magnetic and acid resistant.
Brushed Finish tweezers made from Vommeloy.

**Isolated Tweezers
With Dipped Handles**

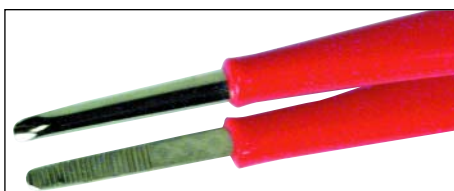

**Blunt End Straight
Isolated & Serrated**

| Item No. | Description | wt. | Each |
|----------|-----------------|------|---------|
| 430 15 | 40 isol - 145mm | .122 | \$14.30 |

Carbon steel. Nickel-plated finish.

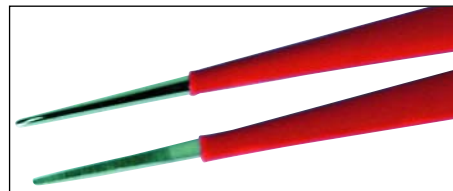

**Narrow Pointed & Straight
Isolated Serrated**

| Item No. | Description | wt. | Each |
|----------|-----------------|------|---------|
| 491 58 | 22 isol - 155mm | .104 | \$15.80 |

Carbon steel. Nickel-plated finish.



Long Bent Tweezer

| Item No. | Description | wt. | Each |
|----------|-----------------|------|---------|
| 432 71 | R29b SA - 160mm | .116 | \$25.10 |

Stainless steel, anti-magnetic and acid resistant.
Brushed Finish tweezers made from Vommeloy.



Made in Germany

Toll Free: (800) 494-6104

Click image to view web page

Professional Quality Tweezers

SELF CLOSING TWEEZERS

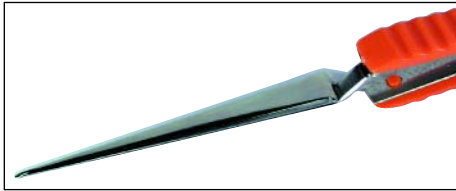

**Pointed Self Closing
Long Straight**

| Item No. | Description | wt. | Each |
|----------|-------------|------|---------|
| 432 72 | R29 - 160mm | .112 | \$20.20 |

Carbon steel. Nickel-plated finish.



**Reverse 2 Flat Round Tip
Smooth Sides**

| Item No. | Description | wt. | Each |
|----------|----------------|------|---------|
| 458 02 | R2a SA - 115mm | .078 | \$26.90 |

Stainless steel, anti-magnetic and acid resistant.
Brushed Finish tweezers made from Vommeloy.



Chip Holding Curved Fine Micro Tip

| Item No. | Description | wt. | Each |
|----------|--------------------|------|---------|
| 466 10 | R10 SA SMD - 117mm | .074 | \$43.90 |

Stainless steel, anti-magnetic and acid resistant.
Brushed Finish tweezers made from Vommeloy.

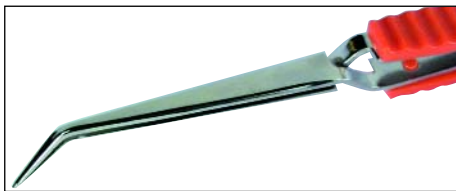

Long Bent Tweezer

| Item No. | Description | wt. | Each |
|----------|--------------|------|---------|
| 432 73 | R29b - 160mm | .118 | \$21.50 |

Carbon steel. Nickel-plated finish.



**Reverse 3 Fine Round Points
For Assembly**

| Item No. | Description | wt. | Each |
|----------|---------------|------|---------|
| 458 03 | R3 SA - 115mm | .078 | \$26.90 |

Stainless steel, anti-magnetic and acid resistant.
Brushed Finish tweezers made from Vommeloy.



Straight Flat Square End 5mm Wide

| Item No. | Description | wt. | Each |
|----------|----------------|------|---------|
| 480 50 | R50 SA - 105mm | .074 | \$29.50 |

Stainless steel, anti-magnetic and acid resistant.
Brushed Finish tweezers made from Vommeloy.

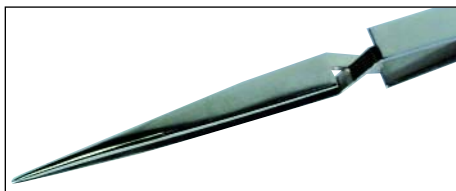

**Pointed Self Closing
LD Long Straight**

| Item No. | Description | wt. | Each |
|----------|-------------|------|---------|
| 432 74 | R28 - 160mm | .110 | \$16.10 |

Carbon steel. Nickel-plated finish.

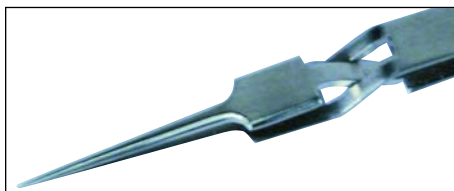

5 Extra Fine Points, Tapered To Tip

| Item No. | Description | wt. | Each |
|----------|---------------|------|---------|
| 458 05 | R5 SA - 105mm | .072 | \$26.90 |

Stainless steel, anti-magnetic and acid resistant.
Brushed Finish tweezers made from Vommeloy.



Bent Flat Square End 5mm Wide

| Item No. | Description | wt. | Each |
|----------|-----------------|------|---------|
| 480 51 | R50b SA - 105mm | .074 | \$32.90 |

Stainless steel, anti-magnetic and acid resistant.
Brushed Finish tweezers made from Vommeloy.



Blunt Heat Dissipating Copper Tips

| Item No. | Description | wt. | Each |
|----------|-------------|------|---------|
| 432 75 | R32 - 160mm | .124 | \$29.90 |

Carbon steel, Copper. Nickel-plated finish.



7 Curved Extra Fine Rounded Tips

| Item No. | Description | wt. | Each |
|----------|----------------|------|---------|
| 458 07 | R7a SA - 115mm | .074 | \$32.50 |

Stainless steel, anti-magnetic and acid resistant.
Brushed Finish tweezers made from Vommeloy.

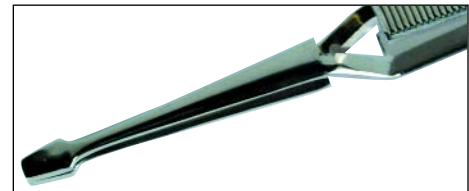

**Strong With Square
Ends Deep Serrated**

| Item No. | Description | wt. | Each |
|----------|-------------|------|---------|
| 480 75 | R30 - 160mm | .126 | \$19.40 |

Carbon steel. Nickel-plated finish.



Made in Germany

www.wihatools.com

Click image to view web page

Interchangeable Tweezers with Heat Protected Plastic Handle

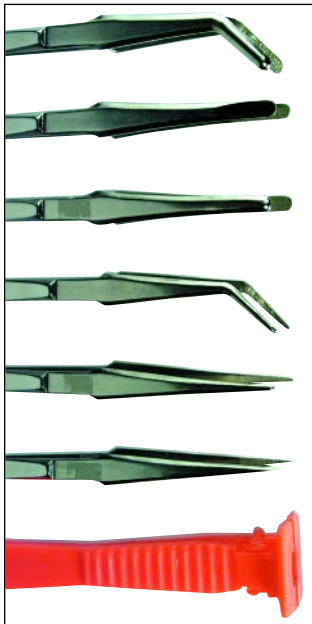

40026 - 16

40025 - 15

40024 - 14

40023 - 13

40022 - 12

40021 - 11

40110 - #10

Molded Handle With Closure Lock

| Item No. | Description | wt. | Each |
|----------|--------------------|------|--------|
| 401 10 | #10 Handle - 100mm | .064 | \$5.30 |

Plastic Molded handle

Long Pointed With Fine Serrations

| Item No. | Description | wt. | Each |
|----------|---------------|------|---------|
| 400 21 | 11 SA - 145mm | .086 | \$14.20 |

Stainless steel, anti-magnetic and acid resistant.
Brushed Finish tweezers made from Vommelaloy.

Long Round Tip With Fine Serrations

| Item No. | Description | wt. | Each |
|----------|---------------|------|---------|
| 400 22 | 12 SA - 145mm | .088 | \$13.70 |

Stainless steel, anti-magnetic and acid resistant.
Brushed Finish tweezers made from Vommelaloy.

Long Round Tip With Fine Serrations

| Item No. | Description | wt. | Each |
|----------|---------------|------|---------|
| 400 23 | 13 SA - 145mm | .086 | \$14.20 |

Stainless steel, anti-magnetic and acid resistant.
Brushed Finish tweezers made from Vommelaloy.

Blunt Round Tip Fine Serrations

| Item No. | Description | wt. | Each |
|----------|---------------|------|---------|
| 400 24 | 14 SA - 145mm | .086 | \$13.50 |

Stainless steel, anti-magnetic and acid resistant.
Brushed Finish tweezers made from Vommelaloy.

Blunt Flat Tips With Fine Serrations

| Item No. | Description | wt. | Each |
|----------|---------------|------|---------|
| 400 25 | 15 SA - 145mm | .088 | \$15.00 |

Stainless steel, anti-magnetic and acid resistant.
Brushed Finish tweezers made from Vommelaloy.

Blunt Round Tip Bent 30°, Fine Serrations

| Item No. | Description | wt. | Each |
|----------|---------------|------|---------|
| 400 26 | 16 SA - 145mm | .088 | \$14.70 |

Stainless steel, anti-magnetic and acid resistant.
Brushed Finish tweezers made from Vommelaloy.



5 Piece Set In Pouch

| Item No. | Description | wt. | Each |
|----------|--------------------|------|---------|
| 400 90 | 5 pc. set in pouch | .282 | \$61.20 |

Set includes: 40021, 40023, 40024, 40026, 40110
Stainless steel, anti-magnetic and acid resistant.
Brushed Finish tweezers made from Vommelaloy.

Inspection Mirrors All Stainless Detachable & Boilable

Mirrors-Clean Room Quality

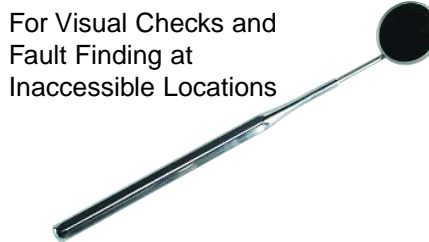

For Visual Checks and Fault Finding at Inaccessible Locations



Magnifying, Boilable

Natural Finish, Stainless Steel

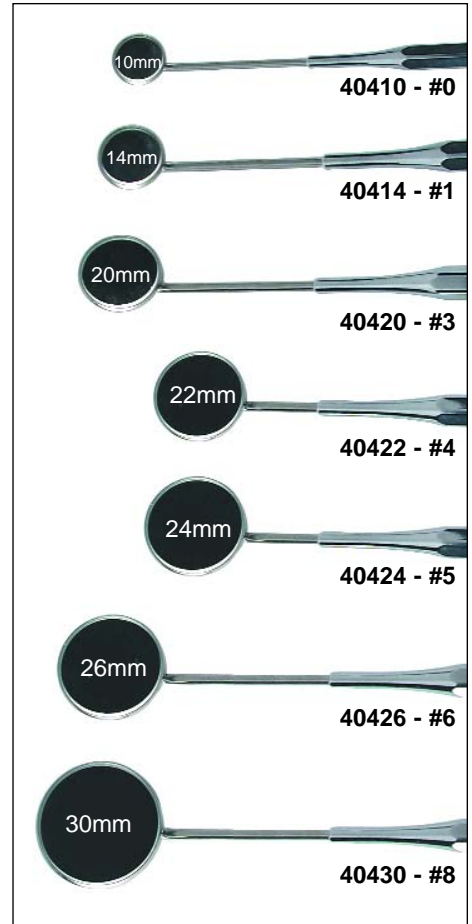

Inspection Mirror - Stainless 10mm

| Item No. | Description | wt. | Each |
|----------|---------------|-----|---------|
| 404 10 | #0 IM - 185mm | .09 | \$29.98 |

Inspection Mirror - Stainless 14mm

| Item No. | Description | wt. | Each |
|----------|---------------|-----|---------|
| 404 14 | #1 IM - 200mm | .09 | \$29.98 |

Inspection Mirror - Stainless 20mm

| Item No. | Description | wt. | Each |
|----------|---------------|-----|---------|
| 404 20 | #3 IM - 205mm | .09 | \$29.98 |

Inspection Mirror - Stainless 22mm Short Stem

| Item No. | Description | wt. | Each |
|----------|---------------|-----|---------|
| 404 22 | #4 IM - 175mm | .10 | \$18.98 |

Inspection Mirror - Stainless 24mm Short Stem

| Item No. | Description | wt. | Each |
|----------|---------------|-----|---------|
| 404 24 | #5 IM - 175mm | .10 | \$18.98 |

Inspection Mirror - Stainless 26mm

| Item No. | Description | wt. | Each |
|----------|---------------|-----|---------|
| 404 26 | #6 IM - 215mm | .10 | \$29.98 |

Inspection Mirror - Stainless 30mm

| Item No. | Description | wt. | Each |
|----------|---------------|-----|---------|
| 404 30 | #8 IM - 215mm | .10 | \$29.98 |



Made in Germany

Toll Free: (800) 494-6104

Click image to view web page

Professional Quality Excavators & Probes

One Piece All Stainless Excavators



Excavators-Clean Room Quality

- Can Be Used as Mini-Spatulas
- For Work on PCB's, Modeling
- Surgical Stainless Steel
- Polished Finish
- Single Piece Construction

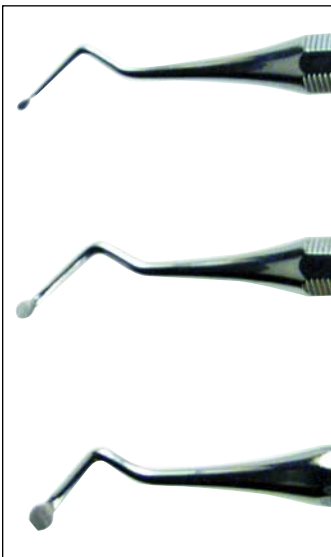

43251-3225.1-39

43252-3225.2-35

43253-3225.3-31

1mm Excavator

| Item No. | Description | wt. | Each |
|----------|-------------------|------|---------|
| 432 51 | 3225.1-39 - 165mm | .094 | \$29.98 |

Stainless steel, polished finish.

2mm Excavator

| Item No. | Description | wt. | Each |
|----------|-------------------|------|---------|
| 432 52 | 3225.2-35 - 165mm | .094 | \$29.98 |

Stainless steel, polished finish.

2.5mm Excavator

| Item No. | Description | wt. | Each |
|----------|-------------------|------|---------|
| 432 53 | 3225.3-31 - 165mm | .096 | \$29.98 |

Stainless steel, polished finish.

One Piece All Stainless Probes

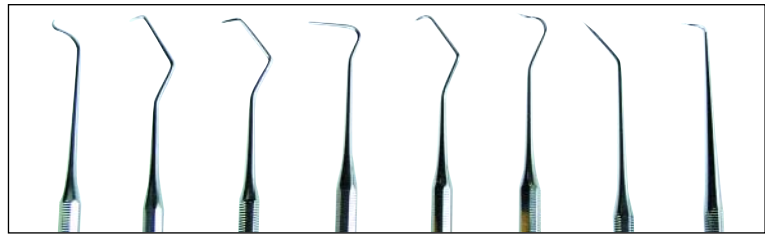

43221 43222 43223 43224 43225 43226 43227 43228

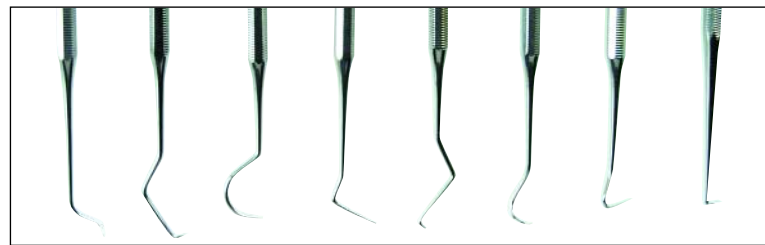

All Stainless Single Piece Construction-Clean Room Quality



Stainless Steel Probe

| Item No. | Description | wt. | Each |
|----------|-------------------------|------|---------|
| 432 21 | 3220.1-07 Probe - 170mm | .074 | \$21.98 |

Stainless steel, polished finish.



Stainless Steel Probe

| Item No. | Description | wt. | Each |
|----------|-------------------------|------|---------|
| 432 24 | 3220.4-16 Probe - 170mm | .074 | \$21.98 |

Stainless steel, polished finish.



Stainless Steel Probe

| Item No. | Description | wt. | Each |
|----------|-------------------------|------|---------|
| 432 22 | 3220.3-06 Probe - 170mm | .074 | \$21.98 |

Stainless steel, polished finish.



Stainless Steel Probe

| Item No. | Description | wt. | Each |
|----------|-------------------------|------|---------|
| 432 25 | 3220.5-09 Probe - 170mm | .074 | \$21.98 |

Stainless steel, polished finish.



Stainless Steel Probe

| Item No. | Description | wt. | Each |
|----------|-------------------------|------|---------|
| 432 23 | 3220.3-05 Probe - 170mm | .074 | \$21.98 |

Stainless steel, polished finish.



Stainless Steel Probe

| Item No. | Description | wt. | Each |
|----------|-------------------------|------|---------|
| 432 26 | 3220.6-10 Probe - 170mm | .074 | \$21.98 |

Stainless steel, polished finish.



Made in Germany

www.wihatools.com

Click image to view web page

Professional Quality Probes & Hooks



Stainless Steel Probe

| Item No. | Description | wt. | Each |
|----------|------------------------------|-----|---------|
| 432 27 | 3220.7-17 Probe - 170mm .074 | | \$21.98 |

Stainless steel, polished finish.



Stainless Steel Probe

| Item No. | Description | wt. | Each |
|----------|------------------------------|-----|---------|
| 432 28 | 3220.8-02 Probe - 170mm .078 | | \$21.98 |

Stainless steel, polished finish.

Probes-Clean Room Quality

- For Levering and Removing Components
- Stainless Steel, For Work on PCB's, Modeling
- Polished Finish



Stainless Steel Straight Probe

| Item No. | Description | wt. | Each |
|----------|------------------------------|-----|---------|
| 432 29 | 3220.9-09 Probe - 170mm .074 | | \$21.98 |

Stainless steel, polished finish.



Soldering Hook

| Item No. | Description | wt. | Each |
|----------|--------------|------|---------|
| 432 30 | 3221 - 165mm | .074 | \$19.98 |

Stainless steel, polished finish.

One Piece All Stainless Hooks

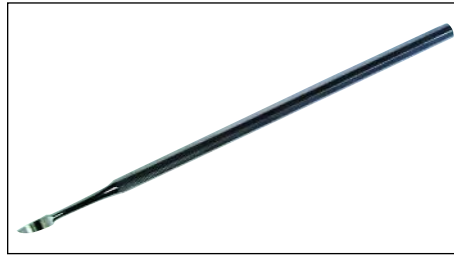

Sculpting & Scribing Hooks-Clean Room Quality

- Sharp Hooks For Cutting and Marking
- Surgical Stainless Steel
- Natural Finish
- For Work on PCB's, Modeling
- All Stainless Single Piece Construction

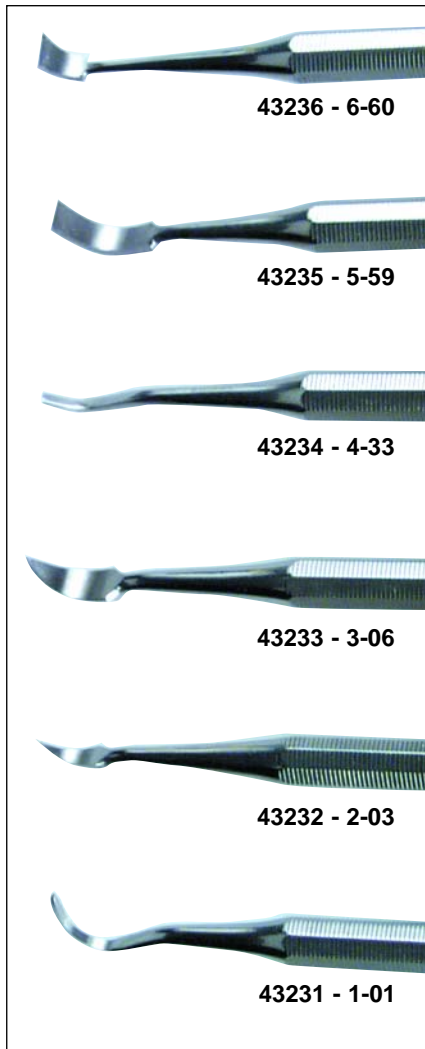

43236 - 6-60

43235 - 5-59

43234 - 4-33

43233 - 3-06

43232 - 2-03

43231 - 1-01

Approx. 2mm Wide Short Tapered & Curved

| Item No. | Description | wt. | Each |
|----------|-----------------------------|-----|---------|
| 432 36 | 3230.6-60 Hook - 155mm .102 | | \$29.98 |

Stainless steel, Natural finish.

Approx. 4mm Wide Squared & Curved

| Item No. | Description | wt. | Each |
|----------|-----------------------------|-----|---------|
| 432 35 | 3230.5-59 Hook - 155mm .100 | | \$29.98 |

Stainless steel, Natural finish.

Approx. 2mm Wide Squared & Curved

| Item No. | Description | wt. | Each |
|----------|-----------------------------|-----|---------|
| 432 34 | 3230.4-33 Hook - 155mm .100 | | \$29.98 |

Stainless steel, Natural finish.

Approx. 4.5mm Wide Sharp Pointed & Curved

| Item No. | Description | wt. | Each |
|----------|-----------------------------|-----|---------|
| 432 33 | 3230.3-06 Hook - 155mm .102 | | \$29.98 |

Stainless steel, Natural finish.

Approx. 3mm Wide Pointed & Curved

| Item No. | Description | wt. | Each |
|----------|-----------------------------|-----|---------|
| 432 32 | 3230.2-03 Hook - 155mm .104 | | \$29.98 |

Stainless steel, Natural finish.

Approx. 2mm Wide Sharp Curved Hook

| Item No. | Description | wt. | Each |
|----------|-----------------------------|-----|---------|
| 432 31 | 3230.1-01 Hook - 155mm .102 | | \$29.98 |

Stainless steel, Natural finish.



Made in Germany

Toll Free: (800) 494-6104

Click on page number to view product

Wiha Bits & Bit Sets Index

| | Description | Page |
|--|-------------------------|-------------|
| | Topra Ratchet Bit Sets | 147 |
| | XSelector Bit Sets | 148 |
| | 6 in 1 Multi Bit Sets | 149 |
| | Bit-Selectors | 150-151,152 |
| | Power Bit-Selectors | 151-152 |
| | Security Bits Collector | 153 |
| | Bit Holders | 154 |
| | Dura Bits | 155 |
| | Diamond Bits | 155 |
| | TiN Coated Bits | 156 |
| | Slotted Bits | 157 |
| | Phillips Bits | 158-159 |
| | Torx Bits | 160-162 |
| | Security Torx Bits | 161-162 |
| | TorxPlus Bits | 161 |
| | Torx Align Bits | 161 |
| | MagicRing Bits | 162 |
| | Hex Bits | 163 |
| | Security Hex Bits | 163 |
| | Pozidriv Bits | 164 |
| | Square Bits | 164-165 |
| | Torq Set Bits | 165 |
| | Tri Wing Bits | 165 |
| | Spanner Bits | 165 |
| | ClicFix Bit Holders | 166 |
| | Nut Setters | 166 |
| | Torx Sockets | 167-169 |
| | Hex Sockets | 167-169 |

Wiha Topra Ratchet Handle

282 Sets Topra Ratchet Sets With Bit Holder and Bits, 12 Pc.
1/4" Magnetic Bit Holder and 10 hardened bits of special chrome-vanadium-molybdenum tool steel.



282 96 Slotted/Phillips/ **TORX** Topra Ratchet Bit Set, 13 Pc.
Set includes Topra Handle, Magnetic bit holder and the following bits: **lbs.**

| | | |
|---|----------------------------------|---------|
| ↓ | Slotted Sizes: 5.5, 6.5, 8.0mm | .69 |
| + | Phillips Sizes: 0, 1, 2, 3 | Each |
| ✳ | TORX Sizes: T10, T15, T20 | \$40.76 |

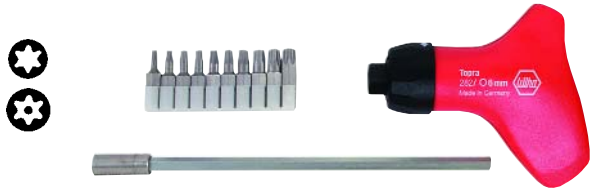

282 95 **TORX** Topra Ratchet Bit Set, 12 Pc.
Set includes Topra Handle, Magnetic bit holder and the following bits: **lbs.**

| | | |
|---|--|--------------|
| ✳ | TORX Sizes: T7, T8, T9, T10, T15, T20, T25, T27, T30, T40 | Each \$45.88 |
|---|--|--------------|

282 97 Tamper Resistant **TORX** Topra Ratchet Bit Set, 12 Pc.
Set includes Topra Handle, Magnetic bit holder and the following bits: **lbs.**

| | | |
|---|---|--------------|
| ✳ | Tamper Resistant TORX Sizes: TR7, TR8, TR9, TR10, TR15, TR20, TR25, TR27, TR30, TR40 | Each \$51.98 |
|---|---|--------------|

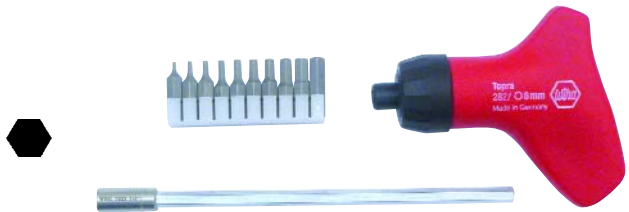

282 98 Hex Inch Topra Ratchet Bit Set, 12 Pc.
Set includes Topra Handle, Magnetic bit holder and the following bits: **lbs.**

| | | |
|---|---|--------------|
| ⬡ | Hex Inch Sizes: 1/16, 5/64, 3/32, 7/64, 1/8, 9/64, 5/32, 3/16, 7/32, 1/4" | Each \$45.86 |
|---|---|--------------|

282 99 Hex Metric Topra Ratchet Bit Set, 10 Pc.
Set includes Topra Handle, Magnetic bit holder and the following bits: **lbs.**

| | | |
|---|--|--------------|
| ⬡ | Hex Metric Sizes: 1.5, 2.0, 2.5, 3.0, 4.0, 5.0, 6.0, 8.0mm | Each \$45.80 |
|---|--|--------------|



Made in Germany

www.wihatools.com

Click image to view web page

Wiha XSelector Bit Sets

It couldn't be smaller!
Compact size and easy bit selection make the NEW XSelector an ideal maintenance tool

Easy bit access with hinged cover



Pocket Sized
3 1/8" x 2 1/8" x 1/2"

Sets include Clicfix quick release holder



794 Sets XSelector Bit Sets

These handy sets include 10 hardened bits of chrome-vanadium-molybdenum steel. 1/4" Quick Release holder can be used in power tools. Quick bit access through integrated bit-clip.

794 47 XSelector Bit Set With Tamper Resistant TORX® Bits

Set Includes ClicFix Quick Release Holder $\frac{1}{4}$ lbs.
and the following 10 bits: .27
 ⚙️ TR TORX® Sizes: TR7, TR8, TR9, TR10, TR15, TR20, TR25, TR27, TR30, TR40 **Each \$29.98**



794 43 XSelector Bit Set With Slotted, Phillips, and TORX® Bits

Set Includes ClicFix Quick Release Holder $\frac{1}{4}$ lbs.
and the following 10 bits: .27
 ⚙️ Slotted Sizes: 5.5, 6.5, 8.0mm
 ⚙️ Phillips Sizes: 0, 1, 2, 3 **Each**
 ⚙️ TORX® Sizes: T10, T15, T20 **\$19.98**



794 50 XSelector Bit Set With Security TORXPlus® Bits

Set Includes ClicFix Quick Release Holder $\frac{1}{4}$ lbs.
and the following 7 bits: .24
 ⚙️ TORXPlus® Sizes: IPR8, PR10, IPR15, IPR20, IPR25, IPR27, IPR30 **Each Call**



794 45 XSelector Bit Set With TORX® Bits

Set Includes ClicFix Quick Release Holder $\frac{1}{4}$ lbs.
and the following 10 bits: .29
 ⚙️ TORX® Sizes: T7, T8, T9, T10, T15, T20, T25, T27, T30, T40 **Each \$23.98**



794 46 XSelector Bit Set With Hex Inch Bits

Set Includes ClicFix Quick Release Holder $\frac{1}{4}$ lbs.
and the following 10 bits: .27
 ⚙️ Hex Inch Sizes: 1/16, 5/64, 3/32, 7/64, 1/8, 9/64, 5/32, 3/16, 7/32, 1/4" **Each \$21.98**



Made in Germany

Toll Free: (800) 494-6104

Click image to view web page

Wiha Multi-Bit Screwdrivers

Six Tools in One!

1/4" Magnetic Bit Holder directs magnetism through the bit for powerful screw holding.

Cap rotates eliminating palm blisters. Allows one handed turning & frees other hand for positioning the work piece.

Ergonomic Powerhandle for maximum comfort and exceptional torque.

Cap snaps on & off. Doesn't unscrew while you're using the tool.

Chambered Bit Storage in the handle. Turn the transparent selector to the bit you need. No time wasted fumbling or sorting to find the right bit.



380 Sets Multi-Bit Screwdriver Sets with Wiha Powerhandle, cellulose-acetate, impact resistant. Snap-lock rotatable cap. Chambered bit holder equipped with transparent selector and 6 bits. 1/4" Bit holder, stainless steel. Shaft chrome-vanadium-molybdenum steel, hardened, chrome-plated. Packaged in clear blister package. Blade Length = 120mm (4.7"). Overall Length = 230mm (9").



380 06 Slotted/Phillips Multi-Bit Screwdriver with Wiha Powerhandle and insulated shaft.
 Set includes the following 1/4" bits:
 † **Slotted Sizes:** 5.5, 6.5, 8.0mm lbs. Each
 † **Phillips Sizes:** 1, 2, 3 .39 \$16.80

380 07 Slotted/Phillips/Square Multi-Bit Screwdriver with Wiha Powerhandle and insulated shaft.
 Set includes the following 1/4" bits:
 † **Slotted Sizes:** 6.5, 8.0mm lbs. Each
 † **Phillips Sizes:** 1, 2 .39 \$17.80
 † **Square Sizes:** 1, 2

Insulation meets VDE, ASTM & IEC specifications



380 03 TORX® Multi-Bit Screwdriver with Wiha Powerhandle.
 Set includes the following 1/4" bits:
 † **TORX® Sizes:** lbs. Each
 T5, T6, T7, T8, T9, T10 .36 \$19.68

380 04 TORX® Multi-Bit Screwdriver with Wiha Powerhandle.
 Set includes the following 1/4" bits:
 † **TORX® Sizes:** lbs. Each
 T8, T9, T10, T15, T20, T25 .36 \$18.68

380 08 TORX® Multi-Bit Screwdriver with Wiha Powerhandle.
 Set includes the following 1/4" bits:
 † **TORX® Sizes:** lbs. Each
 T10, T15, T20, T25, T30, T40 .36 \$19.36

380 09 Tamper Resistant TORX® Screwdriver with Wiha Powerhandle.
 Set includes the following 1/4" bits:
 † **Tamper Resistant TORX® Sizes:** lbs. Each
 TR7, TR8, TR9, TR10, TR15, TR20 .36 \$22.98

380 10 Tamper Resistant TORX® Screwdriver with Wiha Powerhandle.
 Set includes the following 1/4" bits:
 † **Tamper Resistant TORX® Sizes:** lbs. Each
 TR10, TR15, TR20, TR25, TR30, TR40 .36 \$22.98



380 01 Inch Hex Multi-Bit Screwdriver with Wiha Powerhandle.
 Set includes the following 1/4" bits:
 † **Hex Inch Sizes:** lbs. Each
 1/8, 9/64, 5/32, 3/16, 7/32, 1/4" .36 \$18.34

380 02 Metric Hex Multi-Bit Screwdriver with Wiha Powerhandle.
 Set includes the following 1/4" bits:
 † **Hex Metric Sizes:** lbs. Each
 2.0, 2.5, 3.0, 4.0, 5.0, 6.0mm .36 \$18.34



Made in Germany

www.wihatools.com

Click image to view web page

Wiha Bit Selectors

Compact size and easy bit selection make the Bit Selector an ideal maintenance tool.



Plastic storage box is compact, durable and light weight

Slide out drawer allows quick bit access and secure storage



Molded hex cavity in box end. Magnetic adapter fits into opening so tool case can be used as a handle on quick fastening jobs.

1/4" Magnetic Adapter fits all standard 1/4" bits

792 Sets Bit-Selector Sets

These handy sets include 10 hardened bits of chrome-vanadium-molybdenum steel. 1/4" magnetic bit holder can be used in power tools. Plastic storage box is compact, durable and light weight. Molded hex cavity turns box into handle for quick fastening jobs. Quick bit access with slide out drawer. Packaged in clear blister pack.



792 43 Bit-Selector With Slotted, Phillips, and TORX® Bits

Set includes magnetic 1/4" bit holder and the following 10 bits:

- ↓ Slotted Sizes: 5.5, 6.5, 8.0mm .31
- ⊕ Phillips Sizes: 0, 1, 2, 3 Each
- ⊛ TORX® Sizes: T10, T15, T20 \$15.98

792 48 Bit-Selector With Slotted, Phillips, and Square Bits

Set includes magnetic 1/4" bit holder and the following 10 bits:

- ↓ Slotted Sizes: 5.5, 6.5, 8.0mm .32
- ⊕ Phillips Sizes: 0, 1, 2, 3 Each
- ◻ Square Sizes: 1, 2, 3 \$15.98

792 49 Bit Selector With Slotted/Phillips/Pozidriv®/Square and TORX® Bits

Set includes magnetic 1/4" bit holder and the following 10 bits:

- ↓ Slotted Sizes: 5.5, 6.5mm .31
- ⊕ Phillips Sizes: 1, 2
- ⊕ Pozidriv® Sizes: 1, 2
- ◻ Square Sizes: 1, 2 Each
- ⊛ TORX® Sizes: T10, T15 \$15.98



792 45 Bit-Selector With TORX® Bits

Set includes magnetic 1/4" bit holder and the following 10 bits:

- ⊛ TORX® Sizes: T7, T8, T9, T10, T15, T20, T25, T27, T30, T40 .32 Each \$17.98

792 47 Bit-Selector With Tamper Resistant TORX® Bits

Set includes magnetic 1/4" bit holder and the following 10 bits:

- ⊛ Tamper Resistant TORX® Sizes: TR7, TR8, TR9, TR10, TR15, TR20, TR25, TR27, TR30, TR40 .32 Each \$24.98



792 46 Bit-Selector With Hex Inch Bits

Set includes magnetic 1/4" bit holder and the following 10 bits:

- ⬢ Hex Inch Sizes: 1/16, 5/64, 3/32, 7/64, 1/8, 9/64, 5/32, 3/16, 7/32, 1/4" .32 Each \$17.30

792 56 Bit-Selector With Hex Metric Bits

Set includes magnetic 1/4" bit holder and the following 8 bits:

- ⬢ Hex Metric Sizes: 1.5, 2.0, 2.5, 3.0, 4.0, 5.0, 6.0, 8.0mm .30 Each \$17.30



792 50 Bit-Selector With Phillips Bits

Set includes magnetic 1/4" bit holder and the following 10 bits:

- ⊕ Phillips Size: 2 (10 pc.) .32 Each \$10.98

792 51 Bit-Selector With Phillips Bits

Set includes magnetic 1/4" bit holder and the following 10 bits:

- ⊕ Phillips Size: 0 (2 pc.), 1 (2 pc.), 2 (4 pc.), 3 (2 pc.) .32 Each \$11.98



Made in Germany

Toll Free: (800) 494-6104

Click image to view web page

Wiha Insert Bit Selectors



| | | |
|---------------|---|---------|
| 716 90 | Bit-Selector with TorxPlus® bits | |
| | Set includes magnetic 1/4" bit holder | ↔ lbs. |
| | and the following 10 bits: | |
| | TorxPlus® Sizes: | .31 |
| | IP7, IP8, IP9, IP10, IP15, IP20, IP25 | Each |
| | IP27, IP30, IP40 | \$23.98 |



| | | |
|---------------|--|---------|
| 710 90 | Bit-Selector with Slotted, Phillips & Hex 1/4" Bits | |
| | Set includes magnetic 1/4" ClicFix bit holder | ↔ lbs. |
| | and the following 9 bits: | |
| | Slotted Sizes: 4.5, 5.5, 6.5 | .25 |
| | Phillips Sizes: 1, 2, 3 | Each |
| | Hex Sizes: 1/8, 5/32, 3/16 | \$23.48 |



| | | | |
|---------------|--|--------|--------|
| 792 90 | Bit-Selector Case | ↔ lbs. | Each |
| | Empty bit selector case, holds 10 bits | .10 | \$4.10 |
| | and 1/4" bit holder (not included). | | |

Wiha Power Bit Selectors

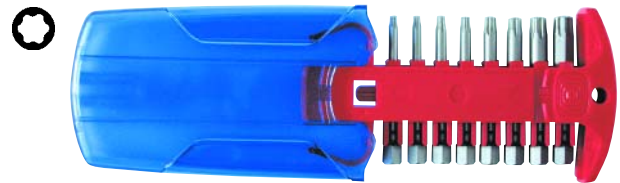

| | | |
|---------------|---|---------|
| 746 90 | Bit-Selector with TORXPlus® power bits - 2" Power Bits | |
| | Set includes the following 8 bits: | ↔ lbs. |
| | TorxPlus® Sizes: | .31 |
| | IP8, IP9, IP10, IP15, IP20 | Each |
| | IP25, IP30, IP40 | \$33.98 |

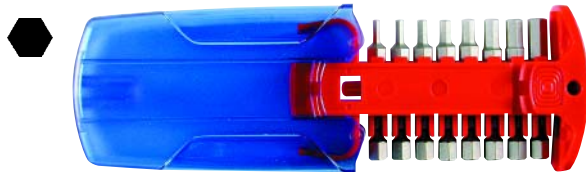

| | | |
|---------------|--|---------|
| 743 97 | Bit-Selector with Hex Inch Power Bits - 2" Power Bits | |
| | Set Includes The Following 8 Bits: | ↔ lbs. |
| | Hex Inch Sizes: | .38 |
| | 3/32, 7/64, 1/8, 9/64, 5/32, | Each |
| | 3/16, 7/32, 1/4 | \$23.40 |



| | | |
|---------------|---|-------------|
| 749 10 | Power Bit-Selector with Slotted/Phillips/Square bits | |
| | Includes: | ↔ lbs. |
| | Slotted: 5.5, 6.5 | Each |
| | Phillips: 1, 2, 3 | .38 \$17.98 |
| | Square: 1, 2, 3 | |

| | | |
|---------------|--|-------------|
| 749 20 | Power Bit-Selector with Slotted/Phillips & TORX® bits | |
| | Includes: | ↔ lbs. |
| | Slotted: 5.5, 6.5 | Each |
| | Phillips: 1, 2, 3 | .37 \$19.98 |
| | TORX®: T15, T20, T25 | |

| | | |
|---------------|---|-------------|
| 749 30 | Power Bit-Selector with TORX® bits | |
| | Includes: | ↔ lbs. |
| | TORX®: T8, T9, T10, T15, | Each |
| | T20, T25, T30, T40 | .36 \$24.44 |

| | | |
|---------------|--|-------------|
| 749 40 | Power Bit-Selector with Tamper Resistant TORX® bits | |
| | Includes: | ↔ lbs. |
| | Tamper Resistant TORX®: | Each |
| | TR8, TR10, TR15, TR20, TR25, | .36 \$31.98 |
| | TR27, TR30, TR40 | |



Made in Germany

www.wihatools.com

Click image to view web page

Wiha Insert and Power Bit-Selectors



| | | |
|---------------|--|---------|
| 710 94 | Bit-Selector With Dura Insert 1/4" Bits | |
| | Set Includes Magnetic 1/4" Bit Holder | ↔ lbs. |
| | & The Following 10 Bits: | |
| ↓ | Slotted Sizes: 5.5, 6.5, 8.0mm | .29 |
| + | Phillips Sizes: 1, 2, 3 | Each |
| ⊕ | TORX® Sizes: T10, T15, T20, T25 | \$57.98 |

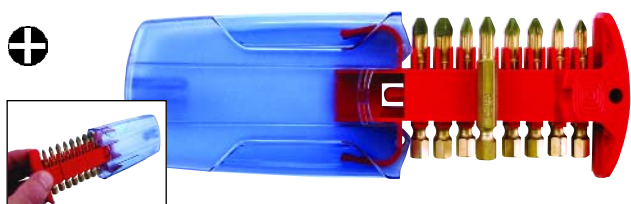

| | | |
|---------------|--|--------------|
| 741 93 | Bit-Selector With Dura Power Bits - 2" Power Bits | |
| + | Phillips Sizes: | lbs. .37 |
| | #1 - qty 2, #2 - qty 4, #3 - qty 2 | Each \$48.98 |



| | | |
|---------------|--|-------------|
| 711 96 | PokitPak - Phillips TiN Coated Insert Bits In Molded Case - | |
| | Set Includes 6 - 1/4" Insert Bits | ↔ lbs. |
| + | Phillips Sizes: 2 of each - 1, 2, 3 | Each |
| | | .31 \$13.70 |



| | | |
|---------------|---|-------------|
| 711 98 | PokitPak - Slotted & Phillips Insert Bits In Molded Case - | |
| | Set Includes 6 - 1/4" Insert Bits & Magnetic Bit Holder | |
| ↓ | Slotted: 4.5, 6.5mm | ↔ lbs. Each |
| + | Phillips: 0, 1, 2, 3 | .15 \$6.60 |

MagicRing

Screw Holding



| | | |
|---------------|---|---------|
| 713 99 | Bit-Selector With Metric & Inch MagicRing Insert 1/4" Bits | |
| | Set Includes Magnetic 1/4" Bit Holder | ↔ lbs. |
| | & The Following 10 Bits: | |
| ⬢ | No Ball End | .46 |
| | Hex Metric Sizes: 3.0, 4.0, 5.0, 6.0 | Each |
| | Hex Inch Sizes: 1/8, 9/64, 5/32, 3/16, 7/32, 1/4" | \$30.50 |

Screw Holding

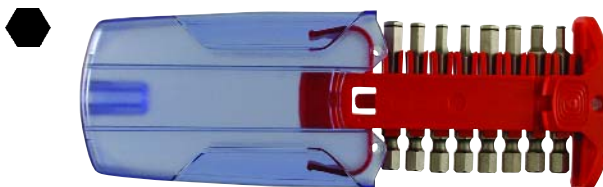
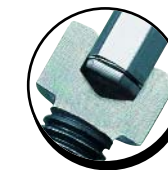

| | | |
|---------------|--|---------|
| 743 99 | Bit-Selector With Metric & Inch MagicRing 1/4" Power Bits | |
| | 2" Power Bits | ↔ lbs. |
| | | lbs. |
| ⬢ | No Ball End | .40 |
| | Hex Metric Sizes: 3.0, 4.0, 5.0, 6.0 | Each |
| | Hex Inch Sizes: 1/8, 5/32, 3/16, 1/4" | \$29.54 |



Made in Germany

Toll Free: (800) 494-6104

Click image to view web page

Wiha Security Bits Collector



719 90 Bits Collector with Security Bits in Tamper Resistant TORX®, Triwing, Torq Set, Spanner, Tamper Resistant Hex, Slotted, Phillips, Pozidriv®, and Square bits. 39 Piece Set

Set includes: Handle, 1/4" magnetic bit holder, 1/4" Bit holding socket adapter and the following 1/4" bits:

⊗ Tamper Resistant TORX® Sizes:

TR8, TR10, TR15, TR20, TR25, TR27, TR30, TR40

⌚ Triwing Sizes: 1, 2, 3, 4

⊕ Torq Set Sizes: 6, 8, 10

⊖ Spanner Sizes: 4, 6, 8, 10

⊗ Tamper Resistant Hex Sizes: 5/64, 3/32, 7/64, 1/8, 9/64, 5/32

⬇️ Slotted Sizes: 6.5, 8.0mm

⊕ Phillips Sizes: 1, 2

⊕ Pozidriv® Sizes: 0, 1, 2, 3

⊖ Square Sizes: 1, 2, 3

⚖️ lbs. 1.03 Each \$66.98

710 95 Bits Collector with Insert Bits Phillips and Hex Bits 51 Piece Set

Set includes: Clicfix quick release bit holder and the following 1/4" bits:

⊕ Phillips Sizes:

10 each of #1 & #2, 5 of #3

⊗ Hex Sizes:

10 each of 1/8 & 3/16, 5 of 5/32

⚖️ lbs. Each \$58.94



Wiha ClicFix Quick Release Holder



719 91 Bits Collector with Security Bits in Tamper Resistant TORX®, Triwing, Torq Set, Spanner, Tamper Resistant Hex, Slotted, Phillips, Pozidriv®, and Square bits. 39 Piece Set

Set includes: Handle, Clicfix quick release bit holder 1/4" Bit holding socket adapter and the following 1/4" bits:

⊗ Tamper Resistant TORX® Sizes:

TR8, TR10, TR15, TR20, TR25, TR27, TR30, TR40

⌚ Triwing Sizes: 1, 2, 3, 4

⊕ Torq Set Sizes: 6, 8, 10

⊖ Spanner Sizes: 4, 6, 8, 10

⊗ Tamper Resistant Hex Sizes: 5/64, 3/32, 7/64, 1/8, 9/64, 5/32

⬇️ Slotted Sizes: 6.5, 8.0mm

⊕ Phillips Sizes: 1, 2

⊕ Pozidriv® Sizes: 0, 1, 2, 3

⊖ Square Sizes: 1, 2, 3

⚖️ lbs. 1.04 Each \$69.98

380 30 ClicFix Quick Release Holder

Blade high alloy chrome-vanadium-molybdenum steel, hardened, chrome-plated. Wiha Powerhandle high quality plastic, impact resistant.

| Item | ⊗ | ⌚ | ⊕ | ⊖ | ⊗ | ⬇️ | ⊕ | ⊖ |
|--------|------|-----|------|-----|------|-----|------|---------|
| No. | Size | mm | Inch | mm | Inch | lbs | pkg. | Each |
| 380 30 | 1/4" | 120 | 4.7 | 230 | 9.0 | .27 | 10 | \$24.98 |

380 33 Slotted, Phillips & ClicFix Quick Release Holder 7 Pc. Set

with Wiha Powerhandle and CVM steel, hardened shaft.

Set includes the following 1/4" bits:

| | | | |
|----|----------------------------|------|---------|
| ⬇️ | Slotted Sizes: 6.5, 8.0mm | lbs. | Each |
| ⊕ | Phillips Sizes: 0, 1, 2, 3 | .43 | \$27.98 |





Made in Germany

www.wihatools.com

Click image to view web page

Wiha Bit Holders



388 00 Bit Holder With Wiha T-handle

Magnetic, holds bit and screw. Retainer out of stainless steel. Hex shaft chrome-vanadium-molybdenum steel, nickel-plated. Wiha-T-handle high quality plastic, impact resistant.

| Item | | | | | | | | |
|--------|------|-----|------|----|------|------|------|--------|
| No. | Size | mm | Inch | mm | Inch | lbs. | pkg. | Each |
| 388 00 | 1/4" | 150 | 6.0 | 80 | 3.0 | .18 | 1 | \$7.98 |



384 1/4" Bit Holding Screwdrivers, With Wiha-SoftFinish® Handle

Ergonomic cushion grip, magnetic, holds bit and screw. Retainer out of stainless steel. Shaft chrome-vanadium-molybdenum steel, nickel-plated.

| Item | | | | | | | | |
|--------|------|-----|------|-----|-------|------|------|---------|
| No. | Size | mm | Inch | mm | Inch | lbs. | pkg. | Each |
| 384 50 | 1/4" | 125 | 5.0 | 240 | 9.46 | .23 | 1 | \$10.50 |
| 384 60 | 1/4" | 300 | 11.8 | 400 | 15.69 | .37 | 1 | \$17.98 |



526 50 1/4" Bit holding Screwdriver, With Wiha-MicroFinish Handle

Non-slip grip, magnetic, holds bit and screw. Retainer out of stainless steel. Shaft chrome-vanadium-molybdenum steel, nickel-plated. Wiha-MicroFinish handle, cellulose-acetate, impact resistant, non-slip, oil and grease resistant.

| Item | | | | | | | | |
|--------|------|-----|------|-----|------|------|------|---------|
| No. | Size | mm | Inch | mm | Inch | lbs. | pkg. | Each |
| 526 50 | 1/4" | 125 | 5.0 | 225 | 8.9 | .24 | 1 | \$13.98 |



484 01 1/4" Bit holding Screwdriver, With Wiha-Ergo 3K Handle

Magnetic, holds bit and screw. Retainer out of stainless steel. Shaft CVM tool steel, nickel plated.

| Item | | | | | | | | |
|--------|------|-----|------|-----|------|------|------|--------|
| No. | Size | mm | Inch | mm | Inch | lbs. | pkg. | Each |
| 484 01 | 1/4" | 125 | 5.0 | 144 | 5.6 | .24 | 1 | \$7.98 |

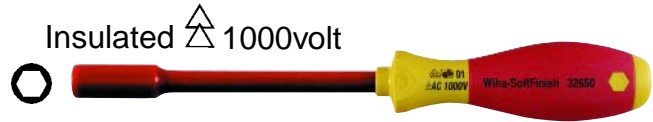

Insulated 1000volt

326 50 Retaining Ring Bit Holding Screwdriver, With Wiha-SoftFinish® Handle

Blade high alloy CVM steel, hardened, black finish. Insulation molded directly onto blade. Holds 1/4" drive bits.

| Item | | | | | | | | |
|--------|------|----|------|-----|------|------|------|---------|
| No. | Size | mm | Inch | mm | Inch | lbs. | pkg. | Each |
| 326 50 | 1/4" | 60 | 2.4 | 164 | 6.5 | .06 | 1 | \$11.98 |

Insulation meets VDE, ASTM & IEC specifications



380 15 Magnetic Bit Holder, 1/4", Wiha-Powerhandle

cellulose-acetate, impact resistant. Snap-lock rotatable cap. Chambered bit holder equipped with transparent selector for easy selection of bits. 1/4" bit holder, stainless steel, magnetic, holds bit and screw. Shaft CVM steel. Cavity holds up to 6 bits. (bits not included)

| Item | | | | | | | | |
|--------|------|-----|------|-----|------|------|------|---------|
| No. | Size | mm | Inch | mm | Inch | lbs. | pkg. | Each |
| 380 15 | 1/4" | 120 | 4.7 | 230 | 9.0 | .25 | 1 | \$11.06 |



Insulated 1000volt

380 25 Magnetic Bit Holder, 1/4", Wiha-Powerhandle, Insulated,

cellulose-acetate, impact resistant. Snap-lock rotatable cap. Chambered bit holder equipped with transparent selector for easy selection of bits. 1/4" bit holder, shielded, magnetic, holds bit and screw. Cavity holds up to 6 bits. (bits not included)

| Item | | | | | | | | |
|--------|------|-----|------|-----|------|------|------|---------|
| No. | Size | mm | Inch | mm | Inch | lbs. | pkg. | Each |
| 380 25 | 1/4" | 120 | 4.7 | 230 | 9.0 | .26 | 1 | \$13.18 |

Insulation meets VDE, ASTM & IEC specifications



668 50 1/4" Bit Holding Screwdriver, With Wiha-Protturn Precision handle.

Magnetic, holds bit and screw. Retainer out of stainless steel. Shaft chrome-vanadium-molybdenum steel, nickel-plated.

| Item | | | | | | | | |
|--------|------|----|------|-----|------|------|------|--------|
| No. | Size | mm | Inch | mm | Inch | lbs. | pkg. | Each |
| 668 50 | 1/4" | 60 | 2.36 | 170 | 6.7 | .07 | 1 | \$6.50 |



Made in Germany

Toll Free: (800) 494-6104

Click image to view web page

Dura Torsion Insert and Power Bits

With the Dura bit Wiha has again proved it's power of innovation. The extra hard, elastic Quattro Torsion bit is equipped with an extremely wear resistant tungsten carbide coating that grips the screw head.

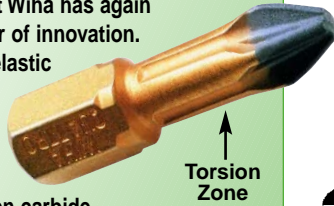

Carbide Coated

Positive location in the screw head with decrease of:

- necessary pressure forces
- working time
- costs
- wear & tear of bits & screw heads
- anti-cam-out effect



710 Dura Bits, Slotted, 1/4"

| Item | ⊖ | ⊖ | ⊖ | ⊖ | ⊖ | Each |
|--------|-----|------|-----|------|----|--------|
| No. | mm | Inch | mm | Inch | mm | |
| 710 10 | 0.6 | .024 | 4.5 | .177 | 25 | \$4.80 |
| 710 11 | 0.8 | .030 | 5.5 | .216 | 25 | \$4.80 |
| 710 12 | 1.0 | .039 | 5.5 | .216 | 25 | \$4.80 |
| 710 13 | 1.2 | .039 | 6.5 | .255 | 25 | \$4.80 |
| 710 14 | 1.2 | .039 | 8.0 | .315 | 25 | \$4.80 |



711 Dura Bits, Phillips, 1/4"

| Item | ⊕ | ⊖ | | |
|--------|----|----|--------|--|
| No. | mm | mm | Each | |
| 711 11 | 1 | 25 | \$4.06 | |
| 711 12 | 2 | 25 | \$4.06 | |
| 711 13 | 3 | 25 | \$4.06 | |



715 Dura Bits, TORX®, 1/4"

| Item | ⊗ | ⊖ | | |
|--------|-----|----|--------|--|
| No. | mm | mm | Each | |
| 715 74 | T10 | 25 | \$6.20 | |
| 715 76 | T15 | 25 | \$6.20 | |
| 715 78 | T20 | 25 | \$6.20 | |
| 715 80 | T25 | 25 | \$6.20 | |
| 715 82 | T30 | 25 | \$6.20 | |
| 715 84 | T40 | 25 | \$6.20 | |



712 Dura Bits, Pozidriv, 1/4"

| Item | ⊕ | ⊖ | | |
|--------|----|----|--------|--|
| No. | mm | mm | Each | |
| 712 11 | 1 | 25 | \$4.06 | |
| 712 12 | 2 | 25 | \$4.06 | |
| 712 13 | 3 | 25 | \$4.06 | |



741 Dura Phillips Power Bits. 1/4" Hex Drive, Length 2.0"/50mm

| Item | ⊕ | ⊖ | | |
|--------|------|----|--------|--|
| No. | Size | mm | Each | |
| 741 41 | 1 | 50 | \$5.50 | |
| 741 42 | 2 | 50 | \$5.50 | |
| 741 43 | 3 | 50 | \$5.50 | |



742 Dura Pozidriv® Power Bits. 1/4" Hex Drive, Length 2.0"/50mm

| Item | ⊕ | ⊖ | | |
|--------|------|----|--------|--|
| No. | Size | mm | Each | |
| 742 41 | 1 | 50 | \$5.50 | |
| 742 42 | 2 | 50 | \$5.50 | |
| 742 43 | 3 | 50 | \$5.50 | |

Diamond Torsion Insert and Power Bits

Diamond bits supplement Wiha's range of high-quality special bits. When used with machines, the increased tool life of the Wiha Diamond bit reduces cost.

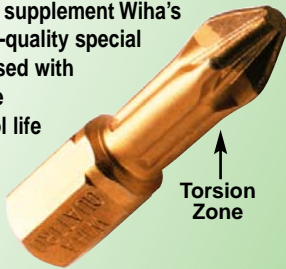

- High wear resistance
- Micro particle coating with sapphire and diamond contents
- Optimized torsion zone

Reduction of:

- pressure forces to be applied
- wear and tear of bit and screw head
- working time
- working costs
- Cam-out effect

The ideal bit even for the most difficult of applications.



710 Diamond Bits, Slotted, 1/4"

| Item | ⊖ | ⊖ | ⊖ | ⊖ | ⊖ | Each |
|--------|-----|------|-----|------|----|--------|
| No. | mm | Inch | mm | Inch | mm | |
| 710 20 | 4.5 | .177 | 0.6 | .024 | 25 | \$4.60 |
| 710 21 | 5.5 | .216 | 0.8 | .030 | 25 | \$4.60 |
| 710 22 | 5.5 | .216 | 1.0 | .039 | 25 | \$4.60 |
| 710 23 | 6.5 | .255 | 1.2 | .039 | 25 | \$4.60 |
| 710 24 | 8.0 | .315 | 1.2 | .063 | 25 | \$4.60 |



711 Diamond Bits, Phillips, 1/4"

| Item | ⊕ | ⊖ | | |
|--------|----|----|--------|--|
| No. | mm | mm | Each | |
| 711 81 | 1 | 25 | \$3.90 | |
| 711 82 | 2 | 25 | \$3.90 | |
| 711 83 | 3 | 25 | \$3.90 | |



712 Diamond Bits, Pozidriv, 1/4"

| Item | ⊕ | ⊖ | | |
|--------|----|----|--------|--|
| No. | mm | mm | Each | |
| 712 21 | 1 | 25 | \$3.90 | |
| 712 22 | 2 | 25 | \$3.90 | |
| 712 23 | 3 | 25 | \$3.90 | |



715 Diamond Bits, TORX®, 1/4"

| Item | ⊗ | ⊖ | | |
|--------|-----|----|--------|--|
| No. | mm | mm | Each | |
| 715 16 | T10 | 25 | \$5.70 | |
| 715 17 | T15 | 25 | \$5.70 | |
| 715 18 | T20 | 25 | \$5.70 | |
| 715 19 | T25 | 25 | \$5.70 | |
| 715 21 | T30 | 25 | \$5.70 | |
| 715 22 | T40 | 25 | \$5.70 | |



741 Diamond Phillips Power Bits. 1/4" Hex Drive, Length 2.0"/50mm

| Item | ⊕ | ⊖ | | |
|--------|------|----|--------|--|
| No. | Size | mm | Each | |
| 741 61 | 1 | 50 | \$5.20 | |
| 741 62 | 2 | 50 | \$5.20 | |
| 741 63 | 3 | 50 | \$5.20 | |



Made in Germany

Toll Free: (800) 494-6104

Click image to view web page

Slotted Bits

The ideal multi-purpose bits for all around quality and performance.



High resistant to wear and tear for a long tool life

Impact resistant modified chrome-vanadium-molybdenum, tool steel, hardened

Suitable for all applications
Hardness HRC 59-61
Suitable for both manual and machine applications

Wiha Slotted Insert Bits and Power Bits



710 Slotted Insert Bits, 1/4" Hex Drive, Length 25mm/.984"

| Item | ↑ | ⊕ | ⊖ | ⊗ | ▬ | |
|--------|-----|------|-----|------|------|--------|
| No. | mm | Inch | mm | Inch | pkg. | Each |
| 710 01 | 4.5 | .177 | 0.6 | .024 | 10 | \$.80 |
| 710 04 | 5.5 | .216 | 0.8 | .030 | 10 | \$.80 |
| 710 02 | 6.5 | .255 | 1.2 | .039 | 10 | \$.80 |
| 710 03 | 8.0 | .315 | 1.6 | .063 | 10 | \$.80 |



743 Slotted and Phillips Double End Bits, 1/4" Hex Drive, Length 2.36"/60mm

| Item | ↑ | ⊕ | ⊖ | ⊗ | ▬ | |
|--------|-------|------|----|------|--------|--|
| No. | Size | Size | mm | pkg. | Each | |
| 743 03 | 6-8 | x 1 | 60 | 10 | \$1.84 | |
| 743 06 | 8-10 | x 2 | 60 | 10 | \$1.84 | |
| 743 09 | 10-12 | x 3 | 60 | 10 | \$1.84 | |



710 55 Slotted Insert Bit Packs, 1" CVM
S2 modified tool steel. Extra hard with natural finish. Exact fit machined tips. 3 pc. bit pack.

710 55 Set includes the following bits:

| Slotted Sizes: | Each |
|---------------------------|--------|
| 5.5, 6.5, 8.0 x 1" (25mm) | \$2.84 |



740 Slotted Power Bits, 1/4" Hex Drive, Length 2.0"/50mm

| Item | ↑ | ⊕ | ⊖ | ⊗ | ▬ | |
|--------|-----|------|-----|------|------|--------|
| No. | mm | Inch | mm | Inch | pkg. | Each |
| 740 03 | 3.0 | .118 | 0.5 | .020 | 10 | \$1.46 |
| 740 06 | 3.5 | .139 | 0.6 | .024 | 10 | \$1.46 |
| 740 09 | 4.0 | .157 | 0.5 | .020 | 10 | \$1.46 |
| 740 10 | 4.0 | .157 | 0.8 | .030 | 10 | \$1.46 |
| 740 12 | 4.5 | .177 | 0.6 | .024 | 10 | \$1.46 |
| 740 15 | 5.5 | .216 | 0.8 | .032 | 10 | \$1.46 |
| 740 18 | 6.5 | .255 | 1.2 | .039 | 10 | \$1.46 |
| 740 21 | 8.0 | .315 | 1.2 | .039 | 10 | \$2.68 |
| 740 23 | 8.0 | .315 | 1.6 | .063 | 10 | \$3.24 |



710 Slotted Insert Bit Packs, 1" CVM S2
modified tool steel.

| Item | ↑ | ⊕ | ⊖ | ⊗ | ▬ | |
|--------|-----|------|------|----|------------|--|
| No. | mm | Size | Inch | mm | 2 Bit Pack | |
| 710 51 | 0.6 | 4.5 | .177 | 25 | \$2.28 | |
| 710 52 | 0.8 | 5.5 | .216 | 25 | \$2.28 | |
| 710 53 | 1.2 | 6.5 | .255 | 25 | \$2.28 | |
| 710 54 | 1.6 | 8.0 | .315 | 25 | \$2.28 | |



740 50 Slotted Power Bit Packs, 2" CVM
S2 modified tool steel. Extra hard with natural finish. Exact fit machined tips. 3 pc. bit pack.

740 50 Set includes the following bits:

| Slotted Sizes: | Each |
|---------------------------|--------|
| 4.5, 5.5, 6.5 x 2" (50mm) | \$8.12 |



Made in Germany

www.wihatools.com

Click image to view web page

Phillips Bits

The ideal multi-purpose bits for all around quality and performance.

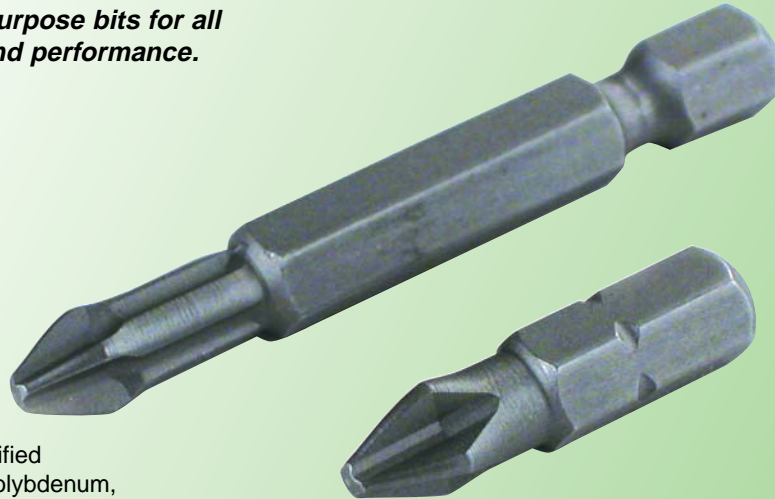

Impact resistant modified chrome-vanadium-molybdenum, tool steel, hardened

High resistant to wear and tear for a long tool life

Suitable for all applications
Hardness HRC 59-61
Suitable for both manual and machine applications

Wiha Phillips Insert Bits and Power Bits



711 Phillips Insert Bits, 1/4"

| Item | + | — | — | — |
|--------|------|----|------|-------|
| No. | Size | mm | pkg. | Each |
| 711 00 | 0 | 25 | 10 | \$.48 |
| 711 01 | 1 | 25 | 10 | \$.48 |
| 711 02 | 2 | 25 | 10 | \$.40 |
| 711 03 | 3 | 25 | 10 | \$.48 |

711 Phillips Insert Bit Bulk Packs, 1/4"

| Item | + | — | — | — |
|--------|------|----|-----------|---------|
| No. | Size | mm | pkg. | Each |
| 711 25 | 2 | 25 | 25 piece | \$9.98 |
| 711 50 | 2 | 25 | 50 piece | \$19.50 |
| 711 99 | 2 | 25 | 100 piece | \$36.90 |



714 Phillips Double End Bits. 1/4" Hex Drive, Length 2.36"/60mm

| Item | + | + | — | — | |
|--------|------|------|----|------|--------|
| No. | Size | Size | mm | pkg. | Each |
| 714 04 | 1 | x 1 | 60 | 10 | \$2.40 |
| 714 14 | 2 | x 2 | 60 | 10 | \$2.40 |
| 714 24 | 3 | x 3 | 60 | 10 | \$2.40 |



741 Phillips Power Bits. 1/4" Hex Drive, Length 2.0"/50mm

| Item | + | — | — | — |
|--------|------|----|------|-------|
| No. | Size | mm | pkg. | Each |
| 741 03 | 1 | 50 | 10 | \$.86 |
| 741 12 | 2 | 50 | 10 | \$.86 |
| 741 24 | 3 | 50 | 10 | \$.86 |



792 50 Bit-Selector With Phillips Bits Set includes magnetic 1/4" bit holder and the following 10 bits:

| Phillips Size: | lbs. | Each |
|----------------|------|---------|
| 2 (10 pc.) | .32 | \$10.98 |

792 51 Bit-Selector With Phillips Bits - Set includes magnetic 1/4" bit holder and the following 10 bits:

| Phillips: | lbs. | Each |
|----------------------|------|---------|
| 0 (2 pc.), 1 (2 pc.) | .32 | \$11.98 |
| 2 (4 pc.), 3 (2 pc.) | | |



743 Slotted and Phillips Double End Bits. 1/4" Hex Drive, Length 2.36"/60mm

| Item | + | + | — | — | |
|--------|-------|------|----|------|--------|
| No. | Size | Size | mm | pkg. | Each |
| 743 03 | 6-8 | x 1 | 60 | 10 | \$1.84 |
| 743 06 | 8-10 | x 2 | 60 | 10 | \$1.84 |
| 743 09 | 10-12 | x 3 | 60 | 10 | \$1.84 |



741 Phillips Power Bits. 1/4" Hex Drive, Length 2.75"/70mm

| Item | + | — | — | — |
|--------|------|----|------|--------|
| No. | Size | mm | pkg. | Each |
| 741 06 | 1 | 70 | 10 | \$1.52 |
| 741 15 | 2 | 70 | 10 | \$1.52 |
| 741 27 | 3 | 70 | 10 | \$1.52 |



Made in Germany

Toll Free: (800) 494-6104

Click image to view web page

Wiha Phillips Insert Bits and Power Bits



741 Phillips Power Bits. 1/4" Hex Drive, Length 3.5"/90mm

| Item | + | — | — | |
|--------|------|----|------|--------|
| No. | Size | mm | pkg. | Each |
| 741 09 | 1 | 90 | 10 | \$1.84 |
| 741 18 | 2 | 90 | 10 | \$1.84 |
| 741 30 | 3 | 90 | 10 | \$1.84 |



741 Phillips Power Bits. 1/4" Hex Drive, Length 4.33"/110mm

| Item | + | — | — | |
|--------|------|-----|------|--------|
| No. | Size | mm | pkg. | Each |
| 741 11 | 1 | 110 | 10 | \$2.10 |
| 741 21 | 2 | 110 | 10 | \$2.10 |
| 741 31 | 3 | 110 | 10 | \$2.10 |



741 Phillips Power Bits. 1/4" Hex Drive, 127mm/5"

| Item | + | — | — | |
|--------|------|-----|------|--------|
| No. | Size | mm | pkg. | Each |
| 741 13 | 1 | 127 | 10 | \$2.20 |
| 741 23 | 2 | 127 | 10 | \$2.20 |
| 741 33 | 3 | 127 | 10 | \$2.20 |



741 Phillips Power Bits. 1/4" Hex Drive, 150mm

| Item | + | — | — | |
|--------|------|-----|------|--------|
| No. | Size | mm | pkg. | Each |
| 741 16 | 1 | 150 | 10 | \$2.30 |
| 741 26 | 2 | 150 | 10 | \$2.30 |
| 741 36 | 3 | 150 | 10 | \$2.30 |



711 Phillips Insert Bit Packs, 1"

CVM S2 modified tool steel

| Item | + | — | |
|--------|------|----|------------|
| No. | Size | mm | 2 Bit Pack |
| 711 49 | 0 | 25 | \$1.52 |
| 711 51 | 1 | 25 | \$1.52 |
| 711 52 | 2 | 25 | \$1.52 |
| 711 53 | 3 | 25 | \$1.52 |



710 56 Slotted/Phillips Insert Bit Packs, 1"

CVM S2 modified tool steel. Extra hard with natural finish, exact fit machined tips. 6 pc. bit pack.

710 56 Set includes the following bits:

| | | |
|---|------------------------|----------------------------|
| ● | Slotted Sizes: | |
| | | 5.5, 6.5, 8.0 x 1" (25mm) |
| + | Phillips Sizes: | Each |
| | | 1, 2, 3 x 1" (25mm) \$4.06 |



711 96 PokitPak - Phillips TiN Coated Insert Bits In Molded Case -

Set Includes 6 - 1/4" Insert Bits

Phillips Sizes: 2 of each - 1, 2, 3

lbs. .31 Each \$13.70



711 54 Phillips Insert Bit Packs, 1" CVM

S2 modified tool steel. Extra hard with natural finish. Exact fit machined tips. 3 pc. bit pack.

711 54 Set includes the following bits:

| | | |
|---|------------------------|----------------------------|
| + | Phillips Sizes: | Each |
| | | 1, 2, 3 x 1" (25mm) \$2.02 |



741 50 Phillips Power Bit Packs, 2" CVM

S2 modified tool steel. Extra hard with natural finish. Exact fit machined tips. 3 pc. bit pack.

741 50 Set includes the following bits:

| | | |
|---|------------------------|----------------------------|
| + | Phillips Sizes: | Each |
| | | 1, 2, 3 x 2" (50mm) \$3.52 |



711 55 Phillips Insert Bit Packs, 1" CVM

S2 modified tool steel. Extra hard with natural finish. Exact fit machined tips. 6 pc. bit pack.

711 55 Set includes the following bits:

| | | |
|---|------------------------|-------------------------------|
| + | Phillips Sizes: | Each |
| | | 6 pieces 2 x 1" (25mm) \$3.46 |



Made in Germany

www.wihatools.com

Click image to view web page

TORX® Bits

The ideal multi-purpose bits for all around quality and performance.

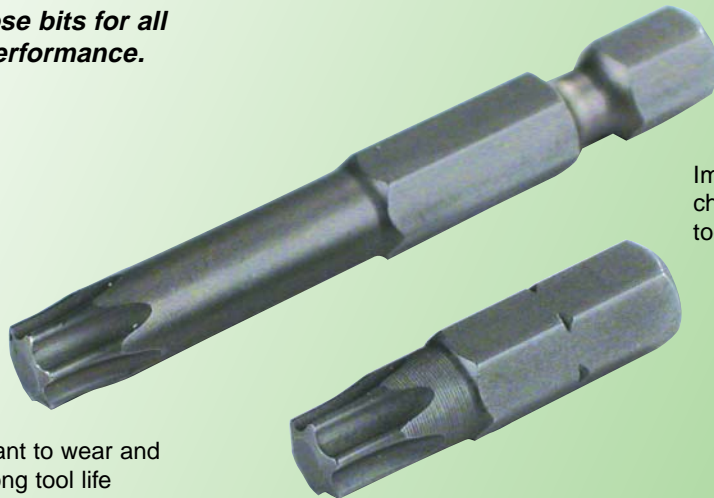

High resistant to wear and tear for a long tool life

Impact resistant modified chrome-vanadium-molybdenum, tool steel, hardened

Suitable for all applications
Hardness HRC 59-61
Suitable for both manual and machine applications



715 TORX® Bits, 1/4"

| Item No. | Size | mm | pkg. | Each |
|----------|------|----|------|--------|
| 715 05 | T5 | 25 | 10 | \$1.20 |
| 715 06 | T6 | 25 | 10 | \$1.20 |
| 715 07 | T7 | 25 | 10 | \$1.20 |
| 715 08 | T8 | 25 | 10 | \$1.20 |
| 715 09 | T9 | 25 | 10 | \$1.20 |
| 715 10 | T10 | 25 | 10 | \$.98 |
| 715 15 | T15 | 25 | 10 | \$.98 |
| 715 20 | T20 | 25 | 10 | \$.98 |
| 715 25 | T25 | 25 | 10 | \$.98 |
| 715 27 | T27 | 25 | 10 | \$.98 |
| 715 30 | T30 | 25 | 10 | \$.98 |
| 715 40 | T40 | 25 | 10 | \$1.20 |



745 TORX® Power Bits. 1/4" Hex Drive, Length 2.0"/50mm

| Item No. | Size | mm | pkg. | Each |
|----------|------|----|------|--------|
| 745 11 | T6 | 50 | 10 | \$2.56 |
| 745 12 | T7 | 50 | 10 | \$2.56 |
| 745 13 | T8 | 50 | 10 | \$2.56 |
| 745 17 | T9 | 50 | 10 | \$2.56 |
| 745 19 | T10 | 50 | 10 | \$2.56 |
| 745 21 | T15 | 50 | 10 | \$2.56 |
| 745 23 | T20 | 50 | 10 | \$2.56 |
| 745 29 | T25 | 50 | 10 | \$2.56 |
| 745 31 | T27 | 50 | 10 | \$2.56 |
| 745 33 | T30 | 50 | 10 | \$2.56 |
| 745 35 | T40 | 50 | 10 | \$2.56 |



745 TORX® Power Bits. 1/4" Hex Drive, Length 3.5"/90mm

| Item No. | Size | mm | pkg. | Each |
|----------|------|----|------|--------|
| 745 63 | T6 | 90 | 10 | \$3.86 |
| 745 65 | T7 | 90 | 10 | \$3.86 |
| 745 67 | T8 | 90 | 10 | \$3.86 |
| 745 69 | T9 | 90 | 10 | \$3.86 |
| 745 71 | T10 | 90 | 10 | \$3.86 |
| 745 73 | T15 | 90 | 10 | \$3.86 |
| 745 75 | T20 | 90 | 10 | \$3.86 |
| 745 77 | T25 | 90 | 10 | \$3.86 |
| 745 79 | T27 | 90 | 10 | \$3.86 |
| 745 81 | T30 | 90 | 10 | \$3.86 |
| 745 83 | T40 | 90 | 10 | \$3.86 |



744 TORX® Double End Bits. 1/4" Hex Drive, Length 2.56"/65mm

| Item No. | Size | Size | mm | pkg. | Each |
|----------|------|------|----|------|--------|
| 744 11 | T6 | T6 | 65 | 10 | \$2.68 |
| 744 13 | T7 | T7 | 65 | 10 | \$2.68 |
| 744 15 | T8 | T8 | 65 | 10 | \$2.68 |
| 744 17 | T9 | T9 | 65 | 10 | \$2.68 |
| 744 19 | T10 | T10 | 65 | 10 | \$2.54 |
| 744 21 | T15 | T15 | 65 | 10 | \$2.54 |
| 744 23 | T20 | T20 | 65 | 10 | \$2.54 |
| 744 29 | T25 | T25 | 65 | 10 | \$2.54 |
| 744 31 | T27 | T27 | 65 | 10 | \$2.54 |
| 744 33 | T30 | T30 | 65 | 10 | \$2.54 |
| 744 35 | T40 | T40 | 65 | 10 | \$2.54 |



745 TORX® Power Bits. 1/4" Hex Drive, Length 2.75"/70mm

| Item No. | Size | mm | pkg. | Each |
|----------|------|----|------|--------|
| 745 36 | T6 | 70 | 10 | \$3.26 |
| 745 38 | T7 | 70 | 10 | \$3.26 |
| 745 42 | T8 | 70 | 10 | \$3.26 |
| 745 44 | T9 | 70 | 10 | \$3.26 |
| 745 46 | T10 | 70 | 10 | \$3.26 |
| 745 48 | T15 | 70 | 10 | \$3.26 |
| 745 51 | T20 | 70 | 10 | \$3.26 |
| 745 53 | T25 | 70 | 10 | \$3.26 |
| 745 56 | T27 | 70 | 10 | \$3.26 |
| 745 58 | T30 | 70 | 10 | \$3.26 |
| 745 61 | T40 | 70 | 10 | \$3.26 |



745 TORX® Power Bits. 1/4" Hex Drive, Length 6.0"/152mm

| Item No. | Size | mm | pkg. | Each |
|----------|------|-----|------|--------|
| 745 86 | T10 | 152 | 10 | \$6.12 |
| 745 87 | T15 | 152 | 10 | \$6.12 |
| 745 88 | T20 | 152 | 10 | \$6.12 |
| 745 89 | T25 | 152 | 10 | \$6.12 |
| 745 90 | T27 | 152 | 10 | \$6.12 |
| 745 91 | T30 | 152 | 10 | \$6.12 |



Made in Germany

Toll Free: (800) 494-6104

Click image to view web page

Wiha TORX® Insert Bits and Power Bits

Torx®
Align



| 715 TORX® Align Bits, 1/4" | | | | |
|----------------------------|------|----|------|--------|
| Item | | | | |
| No. | Size | mm | pkg. | Each |
| 715 36 | T6 | 25 | 10 | \$1.48 |
| 715 37 | T7 | 25 | 10 | \$1.48 |
| 715 38 | T8 | 25 | 10 | \$1.48 |
| 715 39 | T9 | 25 | 10 | \$1.48 |
| 715 41 | T10 | 25 | 10 | \$1.48 |
| 715 42 | T15 | 25 | 10 | \$1.48 |
| 715 43 | T20 | 25 | 10 | \$1.48 |
| 715 44 | T25 | 25 | 10 | \$1.48 |
| 715 45 | T27 | 25 | 10 | \$1.48 |
| 715 46 | T30 | 25 | 10 | \$1.48 |
| 715 47 | T40 | 25 | 10 | \$1.48 |

*Also Known As Torx Wedge Fit

Tamper
Resistant
Torx®



| 701 TR TORX® Bits, Tamper Resistant, 1/4" | | | | |
|---|------|----|------|--------|
| Item | | | | |
| No. | Size | mm | pkg. | Each |
| 701 27 | TR7 | 25 | 10 | \$1.82 |
| 701 28 | TR8 | 25 | 10 | \$1.82 |
| 701 29 | TR9 | 25 | 10 | \$1.82 |
| 701 35 | TR10 | 25 | 10 | \$1.62 |
| 701 39 | TR15 | 25 | 10 | \$1.62 |
| 701 42 | TR20 | 25 | 10 | \$1.62 |
| 701 48 | TR25 | 25 | 10 | \$1.62 |
| 701 60 | TR27 | 25 | 10 | \$1.62 |
| 701 63 | TR30 | 25 | 10 | \$1.62 |
| 701 68 | TR40 | 25 | 10 | \$1.82 |

Torx® Plus



| 716 TORXPlus® Insert Bits, 1/4" Hex, 1" OAL | | | | |
|---|------|----|------|--------|
| Item | | | | |
| No. | Size | mm | pkg. | Each |
| 716 03 | IP3 | 25 | 10 | Call |
| 716 04 | IP4 | 25 | 10 | Call |
| 716 05 | IP5 | 25 | 10 | Call |
| 716 06 | IP6 | 25 | 10 | \$1.50 |
| 716 07 | IP7 | 25 | 10 | \$1.50 |
| 716 08 | IP8 | 25 | 10 | \$1.50 |
| 716 09 | IP9 | 25 | 10 | \$1.22 |
| 716 10 | IP10 | 25 | 10 | \$1.22 |
| 716 15 | IP15 | 25 | 10 | \$1.22 |
| 716 20 | IP20 | 25 | 10 | \$1.22 |
| 716 25 | IP25 | 25 | 10 | \$1.22 |
| 716 27 | IP27 | 25 | 10 | \$1.22 |
| 716 30 | IP30 | 25 | 10 | \$1.50 |
| 716 40 | IP40 | 25 | 10 | \$1.50 |



| 747 TORX® Align Bits, 1/4" Hex Drive, Length 2.0"/50mm | | | | |
|--|------|----|------|--------|
| Item | | | | |
| No. | Size | mm | pkg. | Each |
| 747 11 | T6 | 50 | 10 | \$3.34 |
| 747 14 | T7 | 50 | 10 | \$3.34 |
| 747 17 | T8 | 50 | 10 | \$3.34 |
| 747 21 | T9 | 50 | 10 | \$3.34 |
| 747 24 | T10 | 50 | 10 | \$3.34 |
| 747 28 | T15 | 50 | 10 | \$3.34 |
| 747 32 | T20 | 50 | 10 | \$3.34 |
| 747 36 | T25 | 50 | 10 | \$3.34 |
| 747 39 | T27 | 50 | 10 | \$3.34 |
| 747 42 | T30 | 50 | 10 | \$3.34 |

*Also Known As Torx Wedge Fit



| 705 TORX® Power Bits, Tamper Resistant, 1/4" Hex Drive, Length 2.0"/50mm | | | | |
|--|------|----|------|--------|
| Item | | | | |
| No. | Size | mm | pkg. | Each |
| 705 07 | TR7 | 50 | 10 | \$3.46 |
| 705 08 | TR8 | 50 | 10 | \$3.46 |
| 705 09 | TR9 | 50 | 10 | \$3.46 |
| 705 10 | TR10 | 50 | 10 | \$3.46 |
| 705 15 | TR15 | 50 | 10 | \$3.46 |
| 705 20 | TR20 | 50 | 10 | \$3.46 |
| 705 25 | TR25 | 50 | 10 | \$3.46 |
| 705 27 | TR27 | 50 | 10 | \$3.46 |
| 705 30 | TR30 | 50 | 10 | \$3.46 |
| 705 40 | TR40 | 50 | 10 | \$3.46 |
| 705 45 | TR45 | 50 | 10 | \$3.96 |
| 705 50 | TR50 | 50 | 10 | \$3.96 |
| 705 55 | TR55 | 50 | 10 | \$3.96 |



| 746 TORXPlus® Power Bits, 1/4" Hex, 2" OAL | | | | |
|--|------|----|------|--------|
| Item | | | | |
| No. | Size | mm | pkg. | Each |
| 746 02 | IP6 | 50 | 10 | Call |
| 746 03 | IP7 | 50 | 10 | Call |
| 746 04 | IP8 | 50 | 10 | \$3.18 |
| 746 08 | IP9 | 50 | 10 | \$3.18 |
| 746 12 | IP10 | 50 | 10 | \$3.18 |
| 746 16 | IP15 | 50 | 10 | \$3.18 |
| 746 20 | IP20 | 50 | 10 | \$3.18 |
| 746 24 | IP25 | 50 | 10 | \$3.18 |
| 746 28 | IP27 | 50 | 10 | \$3.18 |
| 746 32 | IP30 | 50 | 10 | \$3.18 |
| 746 36 | IP40 | 50 | 10 | \$3.18 |



Made in Germany

www.wihatools.com

Click image to view web page

Wiha TORX® Insert Bits and Power Bits



716 TORXPlus® Security Insert Bits, 1/4"

Hex, 1" OAL

| Item | No. | Size | mm | pkg. | Each |
|------|--------|-------|----|------|------|
| | 716 48 | IPR8 | 25 | 10 | Call |
| | 716 50 | IPR10 | 25 | 10 | Call |
| | 716 52 | IPR15 | 25 | 10 | Call |
| | 716 54 | IPR20 | 25 | 10 | Call |
| | 716 56 | IPR25 | 25 | 10 | Call |
| | 716 57 | IPR27 | 25 | 10 | Call |
| | 716 58 | IPR30 | 25 | 10 | Call |
| | 716 60 | IPR40 | 25 | 10 | Call |

IPR - 5 point Security TorPlus bits are available for special order to authorized OEM's and their certified service agents. You must submit a written certification/documentation to purchase this product. Call our customer service department: (800) 494-6104 for information.



701 Tamper Resistant Torx® Insert Bit

Packs, 1" CVM S2 modified tool steel

| Item | No. | Size | mm | 2 Bit Pack |
|------|--------|------|----|------------|
| | 701 50 | TR7 | 25 | \$4.18 |
| | 701 51 | TR8 | 25 | \$4.18 |
| | 701 52 | TR9 | 25 | \$4.18 |
| | 701 53 | TR10 | 25 | \$3.78 |
| | 701 54 | TR15 | 25 | \$3.78 |
| | 701 55 | TR20 | 25 | \$3.78 |
| | 701 56 | TR25 | 25 | \$3.78 |
| | 701 57 | TR27 | 25 | \$3.78 |
| | 701 58 | TR30 | 25 | \$3.78 |
| | 701 59 | TR40 | 25 | \$4.18 |



725 TORX® Bits, 5/16"

| Item | No. | Size | mm | pkg. | Each |
|------|--------|------|----|------|--------|
| | 725 40 | T40 | 35 | 10 | \$2.54 |
| | 725 45 | T45 | 35 | 10 | \$2.54 |
| | 725 50 | T50 | 35 | 10 | \$2.54 |
| | 725 55 | T55 | 35 | 10 | \$4.50 |



715 71 Torx® Insert Bit Packs, 1" CVM S2

modified tool steel. Extra hard with natural finish. Exact fit machined tips. 6 pc. bit pack.

715 71 Set includes the following bits:

| Torx® Sizes: | Each |
|----------------------|--------|
| T15, T20, T25, T27, | Each |
| T30, T40 x 1" (25mm) | \$6.60 |

715 70 Torx® Insert Bit Packs, 1" CVM S2

modified tool steel. Extra hard with natural finish. Exact fit machined tips. 6 pc bit pack.

715 70 Set includes the following bits:

| Torx® Sizes: | Each |
|---------------------|---------|
| T5, T6, T7, T8, T9, | Each |
| T10 x 1" (25mm) | \$10.18 |



715 Torx® Insert Bit Packs, 1" CVM S2

modified tool steel

| Item | No. | Size | mm | 2 Bit Pack |
|------|--------|------|----|------------|
| | 715 50 | T5 | 25 | \$3.04 |
| | 715 51 | T6 | 25 | \$3.04 |
| | 715 52 | T7 | 25 | \$3.04 |
| | 715 53 | T8 | 25 | \$3.04 |
| | 715 54 | T9 | 25 | \$3.04 |
| | 715 55 | T10 | 25 | \$2.52 |
| | 715 56 | T15 | 25 | \$2.52 |
| | 715 57 | T20 | 25 | \$2.52 |
| | 715 58 | T25 | 25 | \$2.52 |
| | 715 59 | T27 | 25 | \$2.52 |
| | 715 60 | T30 | 25 | \$2.52 |
| | 715 61 | T40 | 25 | \$3.04 |

Wiha MagicRing Insert/Power Bits

Screw Holding Hex Bits



713 MagicRing Metric Insert Bits, 1/4"

| Item | No. | Size | mm | pkg. | Each |
|------|--------|------|----|------|--------|
| | 713 04 | 3.0 | 25 | 10 | \$2.80 |
| | 713 07 | 4.0 | 25 | 10 | \$2.80 |
| | 713 10 | 5.0 | 25 | 10 | \$2.80 |
| | 713 11 | 6.0 | 25 | 10 | \$2.80 |

713 MagicRing Inch Insert Bits, 1/4"

| Item | No. | Size | mm | pkg. | Each |
|------|--------|------|----|------|--------|
| | 713 43 | 1/8 | 25 | 10 | \$2.80 |
| | 713 46 | 9/64 | 25 | 10 | \$2.80 |
| | 713 49 | 5/32 | 25 | 10 | \$2.80 |
| | 713 52 | 3/16 | 25 | 10 | \$2.80 |
| | 713 54 | 7/32 | 25 | 10 | \$2.80 |
| | 713 58 | 1/4 | 25 | 10 | \$2.80 |



743 MagicRing Metric Power Bits, 1/4"

| Item | No. | Size | mm | pkg. | Each |
|------|--------|------|----|------|--------|
| | 743 01 | 3.0 | 50 | 10 | \$3.30 |
| | 743 05 | 4.0 | 50 | 10 | \$3.30 |
| | 743 07 | 5.0 | 50 | 10 | \$3.30 |
| | 743 19 | 6.0 | 50 | 10 | \$3.30 |

743 MagicRing Inch Power Bits, 1/4"

| Item | No. | Size | mm | pkg. | Each |
|------|--------|------|----|------|--------|
| | 743 69 | 1/8 | 50 | 10 | \$3.30 |
| | 743 71 | 9/64 | 50 | 10 | \$3.30 |
| | 743 73 | 5/32 | 50 | 10 | \$3.30 |
| | 743 75 | 3/16 | 50 | 10 | \$3.30 |
| | 743 77 | 7/32 | 50 | 10 | \$3.30 |
| | 743 79 | 1/4 | 50 | 10 | \$3.30 |



Made in Germany

Toll Free: (800) 494-6104

Click image to view web page

Hex Bits

The ideal multi-purpose bits for all around quality & performance.

High resistant to wear and tear for a long tool life

Impact resistant modified CVM, tool steel, hardened



Suitable for all applications Hardness HRC 59-61 Suitable for both manual and machine applications

See MagicRing Ring Screw Holding Hex Bits on Page 17



713 Hex Metric Insert Bits, 1/4"

| Item No. | Size | mm | pkg. | Each |
|----------|------|----|------|--------|
| 713 03 | 1.5 | 25 | 10 | \$1.08 |
| 713 06 | 2.0 | 25 | 10 | \$1.08 |
| 713 08 | 2.5 | 25 | 10 | \$1.08 |
| 713 09 | 3.0 | 25 | 10 | \$1.08 |
| 713 12 | 4.0 | 25 | 10 | \$1.08 |
| 713 15 | 5.0 | 25 | 10 | \$1.08 |
| 713 18 | 6.0 | 25 | 10 | \$1.08 |
| 713 21 | 8.0 | 25 | 10 | \$2.34 |
| 713 24 | 10.0 | 25 | 10 | \$2.34 |



713 Hex Inch Insert Bits, 1/4"

| Item No. | Size | mm | pkg. | Each |
|----------|------|----|------|--------|
| 713 29 | .050 | 25 | 10 | \$1.08 |
| 713 26 | 1/16 | 25 | 10 | \$1.08 |
| 713 28 | 5/64 | 25 | 10 | \$1.08 |
| 713 30 | 3/32 | 25 | 10 | \$1.08 |
| 713 33 | 7/64 | 25 | 10 | \$1.08 |
| 713 36 | 1/8 | 25 | 10 | \$1.08 |
| 713 39 | 9/64 | 25 | 10 | \$1.08 |
| 713 42 | 5/32 | 25 | 10 | \$1.08 |
| 713 45 | 3/16 | 25 | 10 | \$1.08 |
| 713 48 | 7/32 | 25 | 10 | \$1.08 |
| 713 51 | 1/4 | 25 | 10 | \$1.08 |
| 713 53 | 5/16 | 25 | 10 | \$2.34 |
| 713 56 | 3/8 | 25 | 10 | \$2.34 |



743 Hex Inch Power Bits, 1/4" Hex Drive, Length 2.0"/50mm

| Item No. | Size | mm | pkg. | Each |
|----------|------|----|------|--------|
| 743 11 | 3/32 | 50 | 10 | \$2.96 |
| 743 12 | 7/64 | 50 | 10 | \$2.96 |
| 743 13 | 1/8 | 50 | 10 | \$2.96 |
| 743 14 | 9/64 | 50 | 10 | \$2.96 |
| 743 15 | 5/32 | 50 | 10 | \$2.96 |
| 743 16 | 3/16 | 50 | 10 | \$2.96 |
| 743 17 | 7/32 | 50 | 10 | \$2.96 |
| 743 18 | 1/4 | 50 | 10 | \$2.96 |

743 Hex Metric Power Bits, 1/4" Hex Drive, Length 2.0"/50mm

| Item No. | Size | mm | pkg. | Each |
|----------|------|----|------|--------|
| 743 25 | 2.5 | 50 | 10 | \$2.96 |
| 743 30 | 3.0 | 50 | 10 | \$2.96 |
| 743 40 | 4.0 | 50 | 10 | \$2.96 |
| 743 50 | 5.0 | 50 | 10 | \$2.96 |
| 743 60 | 6.0 | 50 | 10 | \$2.96 |
| 743 80 | 8.0 | 50 | 10 | \$2.96 |



719 Tamper Resistant Hex In Insert Bits, 1/4"

| Item No. | Size | mm | pkg. | Each |
|----------|------|----|------|--------|
| 719 30 | 5/64 | 25 | 10 | \$1.84 |
| 719 32 | 3/32 | 25 | 10 | \$1.84 |
| 719 34 | 7/64 | 25 | 10 | \$1.84 |
| 719 36 | 1/8 | 25 | 10 | \$1.84 |
| 719 38 | 9/64 | 25 | 10 | \$1.84 |
| 719 40 | 5/32 | 25 | 10 | \$1.84 |
| 719 60 | 1/4 | 25 | 10 | \$1.84 |



719 Tamper Resistant Hex Metric Insert Bits, 1/4"

| Item No. | Size | mm | pkg. | Each |
|----------|------|----|------|--------|
| 719 41 | 2.5 | 25 | 10 | \$1.84 |
| 719 42 | 3.0 | 25 | 10 | \$1.84 |
| 719 43 | 4.0 | 25 | 10 | \$1.84 |
| 719 44 | 5.0 | 25 | 10 | \$1.84 |
| 719 45 | 6.0 | 25 | 10 | \$1.84 |
| 719 46 | 8.0 | 25 | 10 | \$3.08 |



713 Hex Inch Insert Bit Packs, 1" CVM S2 modified tool steel

| Item No. | Size | mm | 2 Bit Pack |
|----------|------|----|------------|
| 713 60 | 1/16 | 25 | \$2.62 |
| 713 61 | 5/64 | 25 | \$2.62 |
| 713 62 | 3/32 | 25 | \$2.62 |
| 713 63 | 7/64 | 25 | \$2.62 |
| 713 64 | 1/8 | 25 | \$2.62 |
| 713 65 | 9/64 | 25 | \$2.62 |
| 713 66 | 5/32 | 25 | \$2.62 |
| 713 67 | 3/16 | 25 | \$2.62 |
| 713 68 | 7/32 | 25 | \$2.62 |
| 713 69 | 1/4 | 25 | \$2.62 |

719 Tamper Resistant Hex Inch Insert Bit Packs, 1" CVM S2 modified tool steel

| Item No. | Size | mm | 2 Bit Pack |
|----------|------|----|------------|
| 719 70 | 5/64 | 25 | \$4.26 |
| 719 71 | 3/32 | 25 | \$4.26 |
| 719 72 | 7/64 | 25 | \$4.26 |
| 719 73 | 1/8 | 25 | \$4.26 |
| 719 74 | 9/64 | 25 | \$4.26 |
| 719 75 | 5/32 | 25 | \$4.26 |

719 Tamper Resistant Hex Metric Insert Bit Packs, 1" CVM S2 modified tool steel

| Item No. | Size | mm | 2 Bit Pack |
|----------|------|----|------------|
| 719 80 | 2.5 | 25 | \$4.26 |
| 719 81 | 3.0 | 25 | \$4.26 |
| 719 82 | 4.0 | 25 | \$4.26 |
| 719 83 | 5.0 | 25 | \$4.26 |
| 719 84 | 6.0 | 25 | \$4.26 |



713 96 Hex Inch Insert Bit Packs, 1" CVM S2 modified tool steel. Extra hard with natural finish. Exact fit machined tips. 6 pc. bit pack.

713 96 Set includes the following bits:

| Hex Inch Sizes: | Each |
|------------------------|--------|
| 1/16, 3/32, 1/8, 5/32 | Each |
| 3/16, 1/4" x 1" (25mm) | \$7.18 |

713 97 Hex Metric Insert Bit Packs, 1" CVM S2 modified tool steel. Extra hard with natural finish. Exact fit machined tips. 6 pc bit pack.

713 97 Set includes the following bits:

| Hex Metric Sizes: | Each |
|------------------------------|--------|
| 2.0, 2.5, 3.0, 4.0, 5.0, 6.0 | \$7.18 |



Made in Germany

www.wihatools.com

Click image to view web page

Specialty Bits

The ideal multi-purpose tool to meet high requirements in terms of both quality and performance.

High resistant to wear and tear for a long tool life

Impact resistant modified CVM, tool steel, hardened

Suitable for all applications
Hardness HRC 59-61
Suitable for both manual and machine applications



PoziDriv® Bits



712 PoziDriv® Insert Bits, 1/4"

| Item No. | Size | mm | pkg. | Each |
|----------|------|----|------|-------|
| 712 00 | 0 | 25 | 10 | \$.60 |
| 712 01 | 1 | 25 | 10 | \$.60 |
| 712 02 | 2 | 25 | 10 | \$.60 |
| 712 03 | 3 | 25 | 10 | \$.60 |



742 PoziDriv® Power Bits. 1/4" Hex Drive, Length 2.0"/50mm

| Item No. | Size | mm | pkg. | Each |
|----------|------|----|------|--------|
| 742 03 | 1 | 50 | 10 | \$1.12 |
| 742 12 | 2 | 50 | 10 | \$1.12 |
| 742 21 | 3 | 50 | 10 | \$1.12 |



742 PoziDriv® Power Bits. 1/4" Hex Drive, Length 3.5"/90mm

| Item No. | Size | mm | pkg. | Each |
|----------|------|----|------|--------|
| 742 07 | 1 | 90 | 10 | \$3.36 |
| 742 16 | 2 | 90 | 10 | \$3.36 |
| 742 25 | 3 | 90 | 10 | \$3.36 |



712 PoziDriv® Insert Bit Packs, 1"

CVM S2 modified tool steel

| Item No. | Size | mm | 2 Bit Pack |
|----------|------|----|------------|
| 712 50 | 0 | 25 | \$1.54 |
| 712 51 | 1 | 25 | \$1.54 |
| 712 52 | 2 | 25 | \$1.54 |
| 712 53 | 3 | 25 | \$1.54 |



712 54 PoziDriv® Insert Bit Packs, 1" CVM

S2 modified tool steel. Extra hard with natural finish. Exact fit machined tips. 3 pc. bit pack.

| Item No. | Set includes the following bits: | Each |
|----------|--------------------------------------|--------|
| 712 54 | PoziDriv® Sizes: 1, 2, 3 x 1" (25mm) | \$2.04 |

Square Bits



718 Square Insert Bits, 1/4"

| Item No. | Size | mm | pkg. | Each |
|----------|------|----|------|-------|
| 718 01 | 1 | 25 | 10 | \$.68 |
| 718 02 | 2 | 25 | 10 | \$.68 |
| 718 03 | 3 | 25 | 10 | \$.68 |



748 Square Power Bits. 1/4" Hex Drive, Length 2.0"/50mm

| Item No. | Size | mm | pkg. | Each |
|----------|------|----|------|--------|
| 748 03 | 1 | 50 | 10 | \$1.00 |
| 748 06 | 2 | 50 | 10 | \$1.00 |
| 748 09 | 3 | 50 | 10 | \$1.00 |



748 90 Square Power Bit Packs, 2.0" CVM

S2 modified tool steel. Extra hard with natural finish. Exact fit machined tips. 3 pc. bit pack.

| Item No. | Set includes the following bits: | Each |
|----------|-------------------------------------|--------|
| 748 90 | Square Sizes: 1, 2, 3 x 2.0" (50mm) | \$4.18 |



Made in Germany

Toll Free: (800) 494-6104

Click image to view web page



718 Square Insert Bit Packs, 1" CVM S2

modified tool steel

| Item | ⊖ | ⊖ | | |
|--------|------|----|------------|--|
| No. | Size | mm | 2 Bit Pack | |
| 718 51 | 1 | 25 | \$1.52 | |
| 718 52 | 2 | 25 | \$1.52 | |
| 718 53 | 3 | 25 | \$1.52 | |



719 Torq Set Insert Bit Packs, 1"

CVM S2 modified tool steel

| Item | ⊕ | ⊖ | | |
|--------|------|----|------------|--|
| No. | Size | mm | 2 Bit Pack | |
| 719 57 | 6 | 25 | \$5.12 | |
| 719 58 | 8 | 25 | \$5.12 | |
| 719 59 | 10 | 25 | \$5.12 | |

Spanner Bits



719 Spanner Insert Bits, 1/4"

| Item | ⊖ | ⊖ | ⊖ | |
|--------|------|----|------|--------|
| No. | Size | mm | pkg. | Each |
| 719 14 | 4 | 25 | 10 | \$1.56 |
| 719 16 | 6 | 25 | 10 | \$1.56 |
| 719 18 | 8 | 25 | 10 | \$1.56 |
| 719 20 | 10 | 25 | 10 | \$1.56 |



718 54 Square Insert Bit Packs, 1" CVM

S2 modified tool steel. Extra hard with natural finish. Exact fit machined tips. 3 pc. bit pack.

718 54 Set includes the following bits:

| ⊖ | Square Sizes: | Each |
|---|---------------------|--------|
| | 1, 2, 3 x 1" (25mm) | \$2.52 |

Tri Wing Bits



719 Triwing Insert Bits, 1/4"/25mm

| Item | ⊖ | ⊖ | ⊖ | |
|--------|------|----|------|--------|
| No. | Size | mm | pkg. | Each |
| 719 00 | 0 | 25 | 10 | \$2.14 |
| 719 01 | 1 | 25 | 10 | \$2.14 |
| 719 02 | 2 | 25 | 10 | \$2.14 |
| 719 03 | 3 | 25 | 10 | \$2.14 |
| 719 04 | 4 | 25 | 10 | \$2.14 |
| 719 05 | 5 | 25 | 10 | \$2.14 |



719 Spanner Insert Bit Packs, 1"

CVM S2 modified tool steel

| Item | ⊖ | ⊖ | | |
|--------|------|----|------------|--|
| No. | Size | mm | 2 Bit Pack | |
| 719 63 | 4 | 25 | \$3.66 | |
| 719 64 | 6 | 25 | \$3.66 | |
| 719 65 | 8 | 25 | \$3.66 | |
| 719 66 | 10 | 25 | \$3.66 | |

Torq Set Bits



719 Torq Set Insert Bits, 1/4"

| Item | ⊕ | ⊖ | ⊖ | |
|--------|------|----|------|--------|
| No. | Size | mm | pkg. | Each |
| 719 07 | 4 | 25 | 10 | \$2.14 |
| 719 09 | 5 | 25 | 10 | \$2.14 |
| 719 06 | 6 | 25 | 10 | \$2.14 |
| 719 08 | 8 | 25 | 10 | \$2.14 |
| 719 10 | 10 | 25 | 10 | \$2.14 |



749 Triwing Power Bits, 1/4"/50mm

| Item | ⊖ | ⊖ | ⊖ | |
|--------|------|----|------|--------|
| No. | Size | mm | pkg. | Each |
| 749 01 | 3 | 50 | 10 | \$3.56 |
| 749 02 | 4 | 50 | 10 | \$3.56 |
| 749 03 | 5 | 50 | 10 | \$3.56 |
| 749 04 | 6 | 50 | 10 | \$3.56 |



749 Torq Set Power Bits, 1/4"/50mm

| Item | ⊕ | ⊖ | ⊖ | |
|--------|------|----|------|--------|
| No. | Size | mm | pkg. | Each |
| 749 11 | 4 | 50 | 10 | \$3.56 |
| 749 12 | 5 | 50 | 10 | \$3.56 |
| 749 13 | 6 | 50 | 10 | \$3.56 |
| 749 14 | 8 | 50 | 10 | \$3.56 |
| 749 15 | 10 | 50 | 10 | \$3.56 |



719 Triwing Insert Bit Packs, 1"

CVM S2 modified tool steel

| Item | ⊖ | ⊖ | | |
|--------|------|----|------------|--|
| No. | Size | mm | 2 Bit Pack | |
| 719 49 | 0 | 25 | \$5.80 | |
| 719 50 | 1 | 25 | \$5.80 | |
| 719 51 | 2 | 25 | \$5.80 | |
| 719 52 | 3 | 25 | \$5.80 | |
| 719 53 | 4 | 25 | \$5.80 | |



719 54 Triwing Insert Bit Packs, 1" CVM S2

modified tool steel. Extra hard with natural finish. Exact fit machined tips. 3 pc. bit pack.

719 54 Set includes the following bits:

| ⊖ | Triwing Sizes: | Each |
|---|---------------------|---------|
| | 3, 4, 5 x 1" (25mm) | \$13.98 |



Made in Germany

www.wihatools.com

Click image to view web page

Wiha Bit Holders & Nut Setters

Reduces Down Time • Increases Productivity

ClicFix!

Finally a true one handed quick change bit holder



- Internal bit lock mechanism
- Spring loaded - No fumbling
- One handed bit changes

1 Pull Sleeve Back



2 Remove Bit



3 Insert New Bit



4 Pull Sleeve Forward To Lock





| 714 ClicFix Bit Holder, Magnetic | | | | | |
|----------------------------------|------|------|----|------|---------|
| Item | | | | | |
| No. | Size | Size | mm | Inch | Each |
| 714 90 | 1/4" | 1/4" | 60 | 2.4 | \$10.16 |
| 714 91 | 1/4" | 1/4" | 75 | 2.9 | \$13.98 |

Retaining Ring Bit Holders

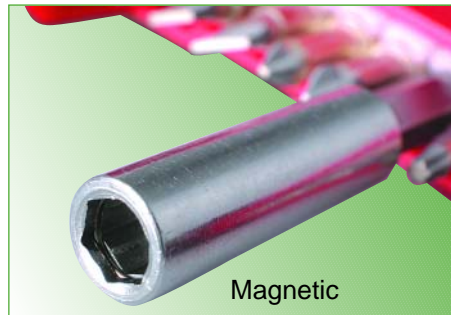

| 711 Universal Power Bit Holder, Magnetic, 1/4" | | | | | |
|--|------|------|----|------|--------|
| Item | | | | | |
| No. | Size | Size | mm | Inch | Each |
| 711 30 | 1/4" | 1/4" | 74 | 2.9 | \$4.80 |
| 711 31 | 1/4" | 1/4" | 59 | 2.3 | \$3.50 |



| 704 Nut Setters Standard. 1/4" Hex Metric | | | |
|---|------|----|--------|
| Item | | | |
| No. | Size | mm | Each |
| 704 03 | 5.0 | 50 | \$3.04 |
| 704 06 | 5.5 | 50 | \$3.04 |
| 704 09 | 6.0 | 50 | \$3.04 |
| 704 12 | 7.0 | 50 | \$3.04 |
| 704 15 | 8.0 | 50 | \$3.04 |
| 704 18 | 10.0 | 50 | \$3.04 |
| 704 21 | 13.0 | 50 | \$3.04 |

| 704 Nut Setters Standard. 1/4" Hex Inch | | | |
|---|------|----|--------|
| Item | | | |
| No. | Size | mm | Each |
| 704 24 | 1/4 | 50 | \$3.04 |
| 704 27 | 5/16 | 50 | \$3.04 |
| 704 30 | 3/8 | 50 | \$3.04 |



| 714 Bit Holder, Retaining Ring & Magnetic | | | | | |
|---|------|------|-----|------|---------|
| Item | | | | | |
| No. | Size | Size | mm | Inch | Each |
| 714 31 | 1/4" | 1/4" | 60 | 2.4 | \$4.36 |
| 714 33 | 1/4" | 1/4" | 67 | 2.6 | \$4.98 |
| 714 35 | 1/4" | 1/4" | 100 | 3.9 | \$6.60 |
| 714 37 | 1/4" | 1/4" | 150 | 5.9 | \$8.86 |
| 714 39 | 1/4" | 1/4" | 200 | 7.8 | \$11.80 |
| 714 41 | 1/4" | 1/4" | 253 | 10.0 | \$14.98 |



| 704 Metric Nut Setters Standard With Permanent Industrial Magnet. 1/4" Hex | | | |
|--|------|----|--------|
| Item | | | |
| No. | Size | mm | Each |
| 704 33 | 5.0 | 50 | \$5.06 |
| 704 36 | 5.5 | 50 | \$5.06 |
| 704 39 | 6.0 | 50 | \$5.06 |
| 704 42 | 7.0 | 50 | \$5.06 |
| 704 45 | 8.0 | 50 | \$5.06 |
| 704 48 | 10.0 | 50 | \$5.06 |
| 704 51 | 13.0 | 50 | \$5.06 |



| 714 Screw Cap Bit Holder with O-Ring | | | | | |
|--------------------------------------|------|------|----|------|--------|
| Item | | | | | |
| No. | Size | Size | mm | Inch | Each |
| 714 93 | 1/4" | 1/4" | 76 | 3.0 | \$6.98 |

| 704 Inch 1/4" Hex Inch Nut Setters | | | |
|------------------------------------|------|----|--------|
| Item | | | |
| No. | Size | mm | Each |
| 704 54 | 1/4 | 50 | \$5.06 |
| 704 57 | 5/16 | 50 | \$5.06 |
| 704 60 | 3/8 | 50 | \$5.06 |



Made in Germany

Toll Free: (800) 494-6104

Click image to view web page

Wiha Sockets



761 TORX® Sockets. 1/4" Square Drive, Set Screw Replaceable Bit

| Item | No. | Size | mm | Each |
|--------|-----|------|--------|------|
| 761 07 | T7 | 38 | \$3.98 | |
| 761 09 | T8 | 38 | \$3.98 | |
| 761 11 | T9 | 38 | \$3.98 | |
| 761 13 | T10 | 38 | \$3.98 | |
| 761 17 | T15 | 38 | \$3.98 | |
| 761 19 | T20 | 38 | \$3.98 | |
| 761 21 | T25 | 38 | \$3.98 | |
| 761 23 | T27 | 38 | \$3.98 | |
| 761 29 | T30 | 38 | \$3.98 | |
| 761 31 | T40 | 38 | \$3.98 | |



763 TORX® Sockets. 3/8" Square Drive, Set Screw Replaceable Bit. 1/4" Bits

| Item | No. | Size | mm | Each |
|--------|-----|------|--------|------|
| 763 12 | T9 | 42 | \$3.98 | |
| 763 14 | T10 | 42 | \$3.98 | |
| 763 16 | T15 | 42 | \$3.98 | |
| 763 18 | T20 | 42 | \$3.98 | |
| 763 22 | T25 | 42 | \$3.98 | |
| 763 24 | T27 | 42 | \$3.98 | |
| 763 26 | T30 | 42 | \$3.98 | |
| 763 28 | T40 | 42 | \$3.98 | |



763 TORX® Sockets. 3/8" Square Drive, Set Screw Replaceable Bit. 5/16" Bit. 2" OAL

| Item | No. | Size | mm | Each |
|--------|-----|------|--------|------|
| 763 46 | T40 | 51 | \$5.98 | |
| 763 48 | T45 | 51 | \$5.98 | |
| 763 52 | T50 | 51 | \$5.98 | |
| 763 54 | T55 | 51 | \$6.98 | |



701 Tamper Resistant TORX® Sockets
3/8" Square drive, set screw replaceable bit. 1/4" bits. 2" OAL

| Item | No. | Size | mm | Each |
|--------|------|------|--------|------|
| 701 07 | TR7 | 38 | \$4.98 | |
| 701 08 | TR8 | 38 | \$4.98 | |
| 701 09 | TR9 | 38 | \$4.98 | |
| 701 10 | TR10 | 38 | \$4.98 | |
| 701 13 | TR15 | 38 | \$4.98 | |
| 701 15 | TR20 | 38 | \$4.98 | |
| 701 17 | TR25 | 38 | \$4.98 | |
| 701 19 | TR27 | 38 | \$4.98 | |
| 701 21 | TR30 | 38 | \$4.98 | |
| 701 23 | TR40 | 38 | \$4.98 | |



339 Square Drive Socket Adapters, With Wiha-T-handle. Blade CVM steel, hardened, chrome-plated, ball retainer. Wiha-T-handle high quality plastic, impact resistant.

| Item | No. | Size | mm | Inch | mm | Inch | lbs. | Each |
|--------|-----|------|-----|------|-----|------|---------|------|
| 339 00 | 1/4 | 150 | 6.0 | 80 | 3.0 | .23 | \$7.90 | |
| 339 20 | 3/8 | 150 | 6.0 | 100 | 4.0 | .23 | \$13.80 | |
| 339 50 | 1/2 | 150 | 6.0 | 100 | 4.0 | .53 | \$18.90 | |

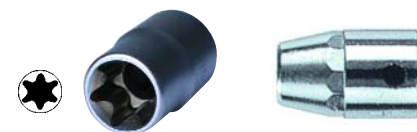

773 TORX® External Sockets
1/4" Square drive socket. Heyco

| Item | No. | Size | mm | Each |
|--------|-----|------|--------|------|
| 773 04 | E4 | 25 | \$5.08 | |
| 773 05 | E5 | 25 | \$5.08 | |
| 773 06 | E6 | 25 | \$5.08 | |
| 773 07 | E7 | 25 | \$5.08 | |
| 773 08 | E8 | 25 | \$5.08 | |
| 773 10 | E10 | 25 | \$5.08 | |

773 TORX® External Sockets
3/8" Square drive socket. Heyco

| Item | No. | Size | mm | Each |
|--------|-----|------|--------|------|
| 773 31 | E8 | 28 | \$8.16 | |
| 773 33 | E10 | 28 | \$8.16 | |
| 773 35 | E12 | 28 | \$8.16 | |
| 773 37 | E14 | 28 | \$8.16 | |



773 TORX® External Sockets
1/2" Square drive socket. Heyco

| Item | No. | Size | mm | Each |
|--------|-----|------|---------|------|
| 773 41 | E12 | 37 | \$10.94 | |
| 773 43 | E14 | 37 | \$10.94 | |
| 773 45 | E16 | 37 | \$10.94 | |
| 773 47 | E18 | 37 | \$10.94 | |
| 773 49 | E20 | 37 | \$10.94 | |
| 773 53 | E24 | 40 | \$10.94 | |



773 90 22 pc. TORX® Set Heyco
1/4" Drive Socket Ratchet 5.5", extension 2" & 4", swivel and hand driver in steel box. Chrome plated & polished. Heyco

| Item No. | lbs. | Set includes the following: |
|----------|------|---|
| 773 90 | 2.14 | E4, E5, E6, E7, E8, E10 |
| \$179.98 | | T6, T7, T8, T9, T10, T15, T20, T25, T27, T30, T40 |



713 Hex Sockets. 1/4" Square drive socket. Replaceable bit. 1/4" bits CVM steel

| Item | No. | Size | mm | Each |
|--------|------|------|--------|------|
| 713 71 | 1/16 | 38 | \$3.98 | |
| 713 70 | 5/64 | 38 | \$3.98 | |
| 713 72 | 3/32 | 38 | \$3.98 | |
| 713 74 | 7/64 | 38 | \$3.98 | |
| 713 76 | 1/8 | 38 | \$3.98 | |
| 713 78 | 9/64 | 38 | \$3.98 | |
| 713 80 | 5/32 | 38 | \$3.98 | |
| 713 82 | 3/16 | 38 | \$3.98 | |
| 713 84 | 7/32 | 38 | \$3.98 | |
| 713 86 | 1/4 | 38 | \$3.98 | |

713 Hex Sockets. 3/8" Square drive socket. Replaceable bit. 1/4" bits CVM tool steel

| Item | No. | Size | mm | Each |
|--------|------|------|--------|------|
| 713 75 | 1/8 | 42 | \$4.98 | |
| 713 77 | 9/64 | 42 | \$4.98 | |
| 713 79 | 5/32 | 42 | \$4.98 | |
| 713 81 | 3/16 | 42 | \$4.98 | |
| 713 83 | 7/32 | 42 | \$4.98 | |
| 713 85 | 1/4 | 42 | \$4.98 | |
| 713 88 | 5/16 | 42 | \$5.98 | |
| 713 90 | 3/8 | 42 | \$5.98 | |



Made in Germany

www.wihatools.com

Click image to view web page

Wiha Sockets



713 Hex Metric Sockets 1/4" Square drive socket. Replaceable bit. 1/4" bits CVM steel

| Item | No. | Size | mm | Each |
|------|--------|------|----|--------|
| | 713 01 | 1.5 | 38 | \$3.98 |
| | 713 02 | 2.0 | 38 | \$3.98 |
| | 713 05 | 2.5 | 38 | \$3.98 |
| | 713 13 | 3.0 | 38 | \$3.98 |
| | 713 14 | 4.0 | 38 | \$3.98 |
| | 713 17 | 5.0 | 38 | \$3.98 |
| | 713 19 | 6.0 | 38 | \$3.98 |



713 Hex Metric Sockets 3/8" Square drive socket. Replaceable bit. 1/4" bits CVM steel

| Item | No. | Size | mm | Each |
|------|--------|------|----|--------|
| | 713 31 | 4.0 | 38 | \$4.98 |
| | 713 23 | 5.0 | 38 | \$4.98 |
| | 713 25 | 6.0 | 38 | \$4.98 |
| | 713 20 | 8.0 | 38 | \$5.98 |
| | 713 22 | 10.0 | 38 | \$5.98 |



771 Slotted Sockets. 1/4" Drive 6" Long Bit Socket

| Item | No. | Size | Inch | Each |
|------|--------|------|------|--------|
| | 771 02 | 3.0 | 6 | \$6.48 |
| | 771 04 | 4.0 | 6 | \$6.48 |
| | 771 06 | 4.5 | 6 | \$6.48 |
| | 771 08 | 5.0 | 6 | \$6.48 |
| | 771 10 | 6.0 | 6 | \$6.48 |
| | 771 12 | 6.5 | 6 | \$6.48 |
| | 771 14 | 8.0 | 6 | \$6.48 |



771 Phillips Sockets 1/4" Drive 6" Long Bit Socket

| Item | No. | Size | Inch | Each |
|------|--------|------|------|--------|
| | 771 16 | 1 | 6 | \$6.48 |
| | 771 18 | 2 | 6 | \$6.48 |
| | 771 20 | 3 | 6 | \$6.48 |



771 Pozidriv® Sockets. 1/4" Drive 6" Long Bit Socket

| Item | No. | Size | Inch | Each |
|------|--------|------|------|--------|
| | 771 22 | 1 | 6 | \$6.48 |
| | 771 24 | 2 | 6 | \$6.48 |
| | 771 26 | 3 | 6 | \$6.48 |



771 Hex Inch Sockets. 1/4" Drive 6" Long Bit Socket

| Item | No. | Size | Inch | Each |
|------|--------|------|------|--------|
| | 771 28 | 3/32 | 6 | \$6.48 |
| | 771 30 | 7/64 | 6 | \$6.48 |
| | 771 32 | 1/8 | 6 | \$6.48 |
| | 771 34 | 9/64 | 6 | \$6.48 |
| | 771 36 | 5/32 | 6 | \$6.48 |
| | 771 38 | 3/16 | 6 | \$6.48 |



771 Hex Metric Sockets. 1/4" Drive 6" Long Bit Socket

| Item | No. | Size | Inch | Each |
|------|--------|------|------|--------|
| | 771 40 | 2.5 | 6 | \$6.48 |
| | 771 42 | 3.0 | 6 | \$6.48 |
| | 771 44 | 4.0 | 6 | \$6.48 |
| | 771 46 | 5.0 | 6 | \$6.48 |
| | 771 48 | 6.0 | 6 | \$6.48 |



771 TORX® Sockets. 1/4" Drive 6" Long Bit Socket

| Item | No. | Size | Inch | Each |
|------|--------|------|------|--------|
| | 771 52 | T10 | 6 | \$6.98 |
| | 771 54 | T15 | 6 | \$6.98 |
| | 771 56 | T20 | 6 | \$6.98 |
| | 771 58 | T25 | 6 | \$6.98 |
| | 771 60 | T27 | 6 | \$6.98 |
| | 771 62 | T30 | 6 | \$6.98 |
| | 771 64 | T40 | 6 | \$6.98 |



771 Tamper Resistant TORX® Sockets. 1/4" Drive 6" Long Bit Socket

| Item | No. | Size | Inch | Each |
|------|--------|------|------|--------|
| | 771 66 | TR10 | 6 | \$6.98 |
| | 771 68 | TR15 | 6 | \$6.98 |
| | 771 70 | TR20 | 6 | \$6.98 |
| | 771 72 | TR25 | 6 | \$6.98 |
| | 771 74 | TR27 | 6 | \$6.98 |
| | 771 76 | TR30 | 6 | \$6.98 |

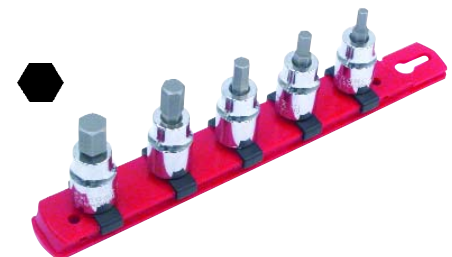

713 94 5 pc. Hex Metric Socket Set

| Item No. | lbs. | 3/8" Drive |
|----------|------|---|
| 713 94 | .00 | Set includes the following: Hex Metric: 4.0, 5.0, 6.0 8.0, 10.0mm |
| Each | | \$26.90 |



Made in Germany

Toll Free: (800) 494-6104

Click image to view web page

Wiha Socket Sets On Molded Rails



761 91 10 pc. TORX® Socket Set
1/4" Square Drive Replaceable Bit Socket. Bits CVM tool steel.
OAL 1.5"

| Item No. | lbs. | Set includes the following: |
|----------------|------|-----------------------------|
| 761 91 | .48 | T7, T8, T9, T10, T15, |
| \$39.98 | | T20, T25, T27, T30, T40 |



763 95 8 pc. TORX® Socket Set
3/8" Square Drive Replaceable Bit Socket. Bits CVM tool steel.
OAL 1.5"

| Item No. | lbs. | Set includes the following: |
|----------------|------|-----------------------------|
| 763 95 | .75 | T9, T10, T15, T20, T25, |
| \$32.98 | | T27, T30, T40 |



763 96 8 pc. TORX® Socket Set
3/8" Square Drive Replaceable Bit Socket. 1/4" & 5/16" Bits CVM tool steel. OAL 1.65"

| Item No. | lbs. | Set includes the following: |
|----------------|------|--------------------------------|
| 763 96 | .84 | 1/4": T20, T25, T27, T30, T40, |
| \$39.98 | | 5/16": T45, T50, T55 |



Security Torx®



701 95 10 pc. Tamper Resistant TORX® Socket Set 1/4" Square drive replaceable bit socket. 1/4" Bits CVM tool steel.

| Item No. | lbs. | Set includes the following: |
|----------------|------|------------------------------|
| 701 95 | .48 | TR7, TR8, TR9, TR10, TR15, |
| \$48.98 | | TR20, TR25, TR27, TR30, TR40 |

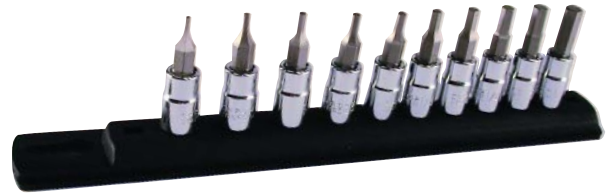

713 91 10 pc. Hex Inch Socket Set
1/4" Square drive replaceable bit socket. Bits CVM tool steel.
OAL 1.5"

| Item No. | lbs. | Set includes the following: |
|----------------|------|------------------------------|
| 713 91 | .48 | 1/16, 5/64, 3/32, 7/64, 1/8 |
| \$39.98 | | 9/64, 5/32, 3/16, 7/32, 1/4" |

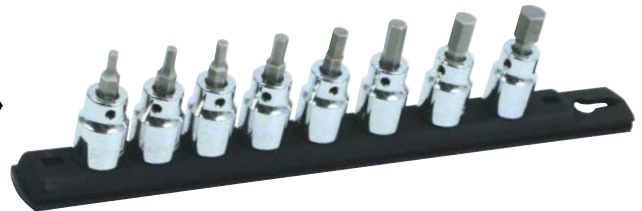

713 92 8 pc. Hex Inch Socket Set
3/8" Square Drive Replaceable Bit Socket. 1/4" Bits CVM tool steel.
OAL 1.65"

| Item No. | lbs. | Set includes the following: |
|----------------|------|------------------------------|
| 713 92 | .78 | 1/8, 9/64, 5/32, 3/16, 7/32, |
| \$36.98 | | 1/4, 5/16, 3/8" |



719 96 9 pc. Hex Metric Socket Set
1/4" & 3/8" Square Drive Replaceable Bit Socket. 1/4" Bits CVM tool steel. OAL 1.65"

| Item No. | lbs. | Set includes the following: |
|----------------|------|---------------------------------|
| 719 96 | .65 | 1/4": 1.5, 2.0, 2.5, 3.0, 4.0mm |
| \$39.98 | | 3/8": 5.0, 6.0, 8.0, 10.0mm |



773 91 8 pc. E-TORX® Socket Set

| Item No. | lbs. | Set includes the following: |
|----------------|------|-----------------------------|
| 773 91 | .62 | 1/4" drive: E6, E7, E8, E10 |
| \$57.98 | | 3/8" drive: E12, E14 |
| | | 1/2" drive: E16, E18 |



Numerical Index by Item Number NIC = Not in Catalog

| Item No. | Page | Each | Item No. | Page | Each | Item No. | Page | Each | Item No. | Page | Each | Item No. | Page | Each | Item No. | Page | Each |
|----------|-------|---------|----------|------|---------|----------|------|---------|----------|--------------|---------|----------|--------------|----------|----------|------|----------|
| 10000 | 77 | \$4.68 | 15315 | 74 | \$5.10 | 26330 | 114 | \$3.00 | 26934 | 123 | \$6.32 | 27805 | 111 | \$6.62 | 28515 | 27 | \$79.98 |
| 10003 | 77 | \$4.68 | 15325 | 74 | \$5.50 | 26331 | 114 | \$3.00 | 26935 | 123 | \$6.12 | 27811 | 111 | \$6.62 | 28516 | 30 | \$131.98 |
| 10006 | 77 | \$4.68 | 15330 | 74 | \$7.30 | 26390 | 114 | \$23.98 | 26936 | 123 | \$5.92 | 27817 | 111 | \$6.62 | 28517 | 27 | \$79.98 |
| 10009 | 77 | \$4.68 | 15335 | 74 | \$8.30 | 26391 | 114 | \$25.98 | 26937 | 123 | \$5.92 | 27823 | 111 | \$6.62 | 28518 | 27 | \$89.98 |
| 10012 | 77 | \$4.68 | 15340 | 74 | \$8.00 | 26413 | 115 | \$3.90 | 26938 | 123 | \$5.40 | 27829 | 111 | \$6.62 | 28519 | 27 | \$89.98 |
| 10015 | 77 | \$4.68 | 16112 | 74 | \$4.40 | 26415 | 115 | \$3.90 | 26939 | 123 | \$5.40 | 27835 | 111 | \$6.92 | 28520 | 30 | \$141.98 |
| 10018 | 77 | \$4.68 | 16134 | 74 | \$10.30 | 26416 | 115 | \$3.90 | 26940 | 123 | \$8.90 | 27841 | 111 | \$7.02 | 28521 | 27 | \$89.98 |
| 10093 | 76,78 | \$25.98 | 18601 | 74 | \$2.00 | 26419 | 115 | \$3.90 | 26941 | 123 | \$8.90 | 27847 | 111 | \$7.14 | 28522 | 31 | \$110.98 |
| 10100 | 77 | \$4.68 | 18603 | 74 | \$2.10 | 26420 | 115 | \$3.90 | 26942 | 123 | \$6.20 | 27890 | 111 | \$39.98 | 28523 | 27 | \$89.98 |
| 10103 | 77 | \$4.68 | 18606 | 74 | \$2.30 | 26423 | 115 | \$3.90 | 26943 | 123 | \$6.40 | 27891 | 111 | \$49.98 | 28524 | 31 | \$111.98 |
| 10106 | 77 | \$4.68 | 18609 | 74 | \$2.40 | 26425 | 115 | \$3.90 | 26944 | 123 | \$6.40 | 27920 | 117 | \$5.90 | 28525 | 27 | \$89.98 |
| 10109 | 77 | \$4.68 | 18612 | 74 | \$2.50 | 26427 | 115 | \$3.90 | 26945 | 123 | \$6.60 | 28000 | 122 | \$5.10 | 28526 | 31 | \$123.98 |
| 10191 | 79 | \$32.98 | 18615 | 74 | \$2.80 | 26430 | 115 | \$3.90 | 26946 | 123 | \$6.60 | 28001 | 122 | \$5.90 | 28534 | 29 | \$4.30 |
| 10195 | 79 | \$53.98 | 18624 | 74 | \$2.90 | 26431 | 115 | \$3.90 | 26947 | 123 | \$6.60 | 28009 | NIC | \$3.98 | 28535 | 29 | \$4.30 |
| 10200 | 77 | \$5.48 | 18627 | 74 | \$3.30 | 26436 | 115 | \$3.90 | 26948 | 123 | \$6.90 | 28021 | 123 | \$3.00 | 28536 | 29 | \$4.30 |
| 10203 | 77 | \$5.48 | 18630 | 74 | \$3.90 | 26439 | 115 | \$3.90 | 26949 | 123 | \$5.40 | 28023 | 123 | \$3.00 | 28537 | 29 | \$4.30 |
| 10206 | 77 | \$5.48 | 18642 | 74 | \$4.20 | 26490 | 115 | \$30.98 | 26950 | 123 | \$6.00 | 28024 | 123 | \$3.00 | 28538 | 29 | \$4.30 |
| 10209 | 77 | \$5.48 | 18645 | 74 | \$4.20 | 26491 | 115 | \$18.98 | 26951 | 123 | \$5.60 | 28025 | 123 | \$3.00 | 28539 | 29 | \$4.30 |
| 10300 | 77 | \$4.68 | 18648 | 74 | \$4.40 | 26510 | 116 | \$3.90 | 26952 | 132 | \$5.60 | 28026 | 123 | \$3.00 | 28540 | 29 | \$4.30 |
| 10303 | 77 | \$4.68 | 18651 | 74 | \$5.00 | 26515 | 116 | \$3.90 | 26953 | 123 | \$5.60 | 28027 | 123 | \$3.00 | 28541 | 29 | \$4.30 |
| 10306 | 77 | \$4.68 | 18654 | 74 | \$5.30 | 26520 | 116 | \$4.10 | 26954 | 123 | \$5.60 | 28028 | 123 | \$3.00 | 28542 | 29 | \$4.30 |
| 10309 | 77 | \$4.68 | 18657 | 74 | \$5.80 | 26523 | 116 | \$4.20 | 26955 | 123 | \$5.60 | 28029 | 123 | \$3.00 | 28543 | 29 | \$4.30 |
| 10312 | 77 | \$4.68 | 18660 | 74 | \$5.90 | 26525 | 116 | \$4.20 | 26956 | 123 | \$5.60 | 28033 | 123 | \$3.00 | 28545 | 29 | \$4.30 |
| 10315 | 77 | \$4.68 | 18663 | 74 | \$6.40 | 26527 | 116 | \$4.20 | 26957 | 123 | \$5.60 | 28034 | 123 | \$3.00 | 28546 | 29 | \$4.30 |
| 10318 | 77 | \$4.68 | 18672 | 74 | \$8.20 | 26530 | 116 | \$4.30 | 26962 | 123 | \$5.40 | 28035 | 123 | \$3.00 | 28547 | 29 | \$4.30 |
| 10400 | 77 | \$4.68 | 18678 | 74 | \$9.10 | 26531 | 116 | \$4.50 | 26963 | 123 | \$5.60 | 28036 | 123 | \$3.00 | 28548 | 29 | \$4.30 |
| 10403 | 77 | \$4.68 | 18681 | 74 | \$9.30 | 26532 | 116 | \$4.40 | 26964 | 123 | \$5.90 | 28037 | 123 | \$3.00 | 28549 | 29 | \$4.30 |
| 10406 | 77 | \$4.68 | 20715 | 74 | \$4.70 | 26535 | 116 | \$4.50 | 26965 | 123 | \$5.90 | 28080 | 124 | \$81.60 | 28550 | 27 | \$99.98 |
| 10409 | 77 | \$4.68 | 20720 | 74 | \$6.70 | 26536 | 116 | \$4.50 | 26966 | 123 | \$5.90 | 28084 | 125 | \$44.98 | 28551 | 27 | \$99.98 |
| 10412 | 77 | \$4.68 | 20725 | 74 | \$11.70 | 26539 | 116 | \$4.60 | 26967 | 123 | \$6.70 | 28087 | 125 | \$38.98 | 28552 | 27 | \$109.98 |
| 10500 | 77 | \$5.30 | 20790 | 74 | \$36.98 | 26540 | 116 | \$4.60 | 26968 | 123 | \$6.70 | 28088 | 125 | \$49.60 | 28553 | 27 | \$112.98 |
| 10503 | 77 | \$5.30 | 22220 | 74 | \$6.70 | 26545 | 116 | \$4.60 | 26969 | 123 | \$6.70 | 28091 | 125 | \$38.70 | 28554 | 27 | \$119.98 |
| 10506 | 77 | \$5.30 | 22230 | 74 | \$7.70 | 26547 | 116 | \$4.60 | 26971 | 122 | \$7.70 | 28092 | discontinued | | 28555 | 29 | \$4.30 |
| 10509 | 77 | \$5.30 | 26000 | 117 | \$2.40 | 26550 | 116 | \$4.60 | 26972 | 122 | \$7.30 | 28094 | 125 | \$71.38 | 28556 | 29 | \$4.30 |
| 10512 | 77 | \$5.30 | 26001 | 117 | \$3.30 | 26555 | 116 | \$4.80 | 26973 | 122 | \$6.60 | 28097 | 125 | \$49.98 | 28557 | 29 | \$4.30 |
| 10515 | 77 | \$5.30 | 26008 | 113 | \$5.20 | 26556 | 116 | \$4.80 | 26974 | 122 | \$6.60 | 28098 | 125 | \$47.98 | 28558 | 29 | \$4.30 |
| 10518 | 77 | \$5.30 | 26010 | 113 | \$4.80 | 26560 | 116 | \$4.80 | 26987 | 126 | \$38.76 | 28101 | 76 | \$5.98 | 28559 | 29 | \$4.30 |
| 10521 | 77 | \$5.30 | 26012 | 113 | \$3.90 | 26563 | 116 | \$4.80 | 26988 | 126 | \$49.60 | 28104 | 76 | \$7.68 | 28560 | 29 | \$4.30 |
| 10524 | 77 | \$5.30 | 26015 | 113 | \$3.80 | 26570 | 116 | \$4.80 | 26989 | 126 | \$32.52 | 28200 | 76 | \$29.98 | 28561 | 29 | \$4.30 |
| 10600 | 77 | \$5.30 | 26018 | 113 | \$3.50 | 26590 | 116 | \$36.98 | 26990 | 124 | \$28.58 | 28294 | 80 | \$120.98 | 28562 | 29 | \$4.30 |
| 10603 | 77 | \$5.30 | 26020 | 113 | \$3.20 | 26591 | 116 | \$35.98 | 26991 | 124 | \$43.98 | 28295 | 19,147 | \$45.88 | 28563 | 29 | \$4.30 |
| 10606 | 77 | \$5.30 | 26022 | 113 | \$3.50 | 26592 | 116 | \$28.98 | 26992 | 124 | \$69.98 | 28296 | 147 | \$40.76 | 28564 | 29 | \$4.30 |
| 10609 | 77 | \$5.30 | 26023 | 113 | \$3.50 | 26703 | 117 | \$4.50 | 26993 | 125 | \$49.98 | 28297 | 19,147 | \$51.98 | 28565 | 29 | \$4.30 |
| 10612 | 77 | \$5.30 | 26025 | 113 | \$3.20 | 26704 | 117 | \$4.50 | 26994 | discontinued | | 28298 | 147 | \$45.86 | 28566 | 29 | \$4.30 |
| 10615 | 77 | \$5.30 | 26027 | 113 | \$3.30 | 26705 | 117 | \$4.50 | 26995 | 126 | \$25.90 | 28299 | 147 | \$45.80 | 28567 | 29 | \$4.30 |
| 10618 | 77 | \$5.30 | 26028 | 113 | \$3.50 | 26706 | 117 | \$4.60 | 26996 | 126 | \$32.00 | 28406 | 78 | \$7.00 | 28568 | 29 | \$4.30 |
| 10621 | 77 | \$5.30 | 26030 | 113 | \$3.20 | 26707 | 117 | \$4.60 | 26997 | 126 | \$53.40 | 28407 | 78 | \$7.00 | 28569 | 29 | \$4.30 |
| 10624 | 77 | \$5.30 | 26032 | 113 | \$3.40 | 26708 | 117 | \$4.60 | 26998 | 126 | \$58.98 | 28412 | 78 | \$7.00 | 28571 | 29 | \$4.30 |
| 10627 | 77 | \$5.30 | 26033 | 113 | \$3.40 | 26709 | 117 | \$4.60 | 26999 | 112 | \$32.52 | 28422 | 78 | \$7.00 | 28572 | 29 | \$4.30 |
| 10630 | 77 | \$5.30 | 26034 | 113 | \$3.80 | 26710 | 117 | \$4.80 | 27009 | 112 | \$11.10 | 28431 | 78 | \$7.70 | 28573 | 29 | \$4.30 |
| 10633 | 77 | \$5.30 | 26035 | 113 | \$3.50 | 26715 | 117 | \$4.80 | 27013 | 112 | \$11.10 | 28432 | 78 | \$7.70 | 28574 | 29 | \$4.30 |
| 10691 | 79 | \$43.98 | 26040 | 113 | \$3.60 | 26720 | 117 | \$4.80 | 27018 | 112 | \$11.10 | 28433 | 78 | \$7.70 | 28575 | 29 | \$4.30 |
| 10700 | 19,77 | \$4.68 | 26041 | 113 | \$3.80 | 26790 | 117 | \$27.98 | 27026 | 112 | \$11.10 | 28434 | 78 | \$7.70 | 28576 | 29 | \$4.30 |
| 10703 | 19,77 | \$4.68 | 26042 | 113 | \$4.30 | 26792 | 117 | \$32.98 | 27090 | 112 | \$33.98 | 28435 | 78 | \$7.70 | 28577 | 29 | \$4.30 |
| 10706 | 19,77 | \$4.68 | 26090 | 113 | \$20.98 | 26810 | 117 | \$4.50 | 27100 | 112 | \$11.10 | 28438 | 78 | \$6.60 | 28578 | 29 | \$4.30 |
| 10709 | 19,77 | \$4.68 | 26092 | 114 | \$25.98 | 26900 | 122 | \$5.10 | 27215 | 110 | \$5.20 | 28441 | 78 | \$6.60 | 28579 | 29 | \$4.30 |
| 10712 | 19,77 | \$4.68 | 26100 | 113 | \$3.90 | 26901 | 122 | \$5.90 | 27220 | 110 | \$4.48 | 28442 | 78 | \$6.60 | 28581 | 28 | \$6.98 |
| 10715 | 19,77 | \$4.68 | 26101 | 113 | \$3.90 | 26903 | 122 | \$7.60 | 27225 | 110 | \$4.48 | 28443 | 78 | \$6.80 | 28582 | 28 | \$6.98 |
| 10718 | 19,77 | \$4.68 | 26102 | 113 | \$5.10 | 26904 | 122 | \$7.30 | 27230 | 110 | \$4.08 | 28444 | 78 | \$6.80 | 28583 | 28 | \$6.98 |
| 10721 | 19,77 | \$4.68 | 26105 | 113 | \$3.50 | 26905 | 122 | \$7.00 | 27235 | 110 | \$4.88 | 28446 | 78 | \$6.80 | 28587 | 29 | \$4.30 |
| 10724 | 19,77 | \$4.68 | 26107 | 113 | \$3.60 | 26911 | 122 | \$7.00 | 27240 | 110 | \$4.98 | 28449 | 78 | \$7.00 | 28588 | 29 | \$4.30 |
| 10791 | 19,79 | \$43.98 | 26108 | 113 | \$3.40 | 26912 | 122 | \$6.10 | 27302 | 110 | \$6.90 | 28451 | 19,78 | \$7.40 | 28590 | 28 | \$149.98 |
| 10810 | 76 | \$5.00 | 26109 | 113 | \$3.90 | 26913 | 123 | \$3.68 | 27305 | 110 | \$5.10 | 28452 | 19,78 | \$7.40 | 28592 | 31 | \$164.98 |
| 10820 | 76 | \$5.50 | 26110 | 113 | \$3.80 | 26914 | 123 | \$3.68 | 27310 | 110 | \$4.80 | 28453 | 19,78 | \$7.40 | 28595 | 28 | \$195.98 |
| 10830 | 76 | \$6.00 | 26113 | 113 | \$3.80 | 26915 | 123 | \$3.50 | 27320 | 110 | \$4.88 | 28454 | 19,78 | \$7.40 | 28701 | 30 | \$5.70 |
| 10900 | 78 | \$5.20 | 26114 | 113 | \$3.80 | 26916 | 123 | \$3.50 | 27390 | 111 | \$31.98 | 28455 | 19,78 | \$7.40 | 28703 | 30 | \$5.70 |
| 10910 | 78 | \$5.20 | 26115 | 113 | \$4.30 | 26917 | 123 | \$3.50 | 27513 | 112 | \$4.90 | 28473 | 78 | \$7.00 | 28705 | 30 | \$5.70 |
| 10920 | 78 | \$5.20 | 26190 | 114 | \$23.98 | 26918 | 123 | \$3.50 | 27515 | 112 | \$4.60 | 28474 | 78 | \$7.00 | 28707 | 30 | \$5.70 |
| 10951 | 79 | \$55.98 | 26192 | 114 | \$20.98 | 26919 | 123 | \$3.08 | 27520 | 112 | \$4.18 | 28475 | 78 | \$7.00 | 28710 | 30 | \$5.70 |
| 11103 | 19,77 | \$5.98 | 26194 | 114 | \$16.98 | 26920 | 123 | \$3.08 | 27525 | 112 | \$4.28 | 28501 | 27 | \$89.98 | 28711 | 30 | \$5.70 |
| 11105 | 19,77 | \$5.98 | 26205 | 115 | \$3.60 | 26921 | 123 | \$4.10 | 27530 | 112 | \$3.98 | 28502 | 27 | \$89.98 | 28712 | 30 | \$5.70 |
| 11107 | 19,77 | \$5.98 | 26210 | 115 | \$3.60 | | | | | | | | | | | | |



Toll Free: (800) 494-6104

Click on page number to view product

Made in Germany

Numerical Index by Item Number NIC = Not in Catalog

| Item No. | Page | Each | Item No. | Page | Each | Item No. | Page | Each | Item No. | Page | Each | Item No. | Page | Each | Item No. | Page | Each |
|----------|------|---------|----------|--------|----------|----------|--------------|----------|----------|------|----------|----------|--------|---------|----------|------|---------|
| 28826 | 31 | \$5.20 | 32100 | 82 | \$4.60 | 32678 | 100 | \$21.98 | 32946 | 92 | \$27.98 | 33900 | 52,167 | \$7.90 | 34424 | 45 | \$1.12 |
| 28827 | 31 | \$5.20 | 32101 | 82 | \$5.30 | 32680 | 100 | \$24.98 | 32950 | 95 | \$35.98 | 33920 | 52,167 | \$13.80 | 34426 | 45 | \$1.12 |
| 28828 | 31 | \$5.20 | 32102 | 82 | \$6.70 | 32681 | 101 | \$15.98 | 32953 | 95 | \$37.98 | 33950 | 52,167 | \$18.90 | 34428 | 45 | \$1.12 |
| 28829 | 31 | \$5.20 | 32103 | 82 | \$9.50 | 32682 | 101 | \$15.98 | 32962 | 94 | \$32.98 | 34000 | 46 | \$5.28 | 34430 | 45 | \$3.20 |
| 28830 | 31 | \$5.20 | 32190 | 83 | \$155.98 | 32683 | 101 | \$16.98 | 32969 | 94 | \$43.98 | 34002 | 46 | \$1.20 | 34432 | 45 | \$2.90 |
| 30001 | 80 | \$7.00 | 32206 | 53,84 | \$7.70 | 32684 | 101 | \$17.98 | 32990 | 95 | \$126.98 | 34004 | 46 | \$5.20 | 34434 | 45 | \$3.20 |
| 30002 | 80 | \$5.60 | 32209 | 53,84 | \$7.90 | 32685 | 101 | \$17.98 | 32991 | 95 | \$229.98 | 34006 | 46 | \$5.60 | 34436 | 45 | \$3.20 |
| 30101 | 80 | \$6.90 | 32212 | 53,84 | \$7.90 | 32686 | 101 | \$17.98 | 33401 | 38 | \$2.90 | 34008 | 46 | \$5.40 | 34438 | 45 | \$6.40 |
| 30102 | 80 | \$5.50 | 32215 | 53,84 | \$7.90 | 32687 | 101 | \$17.98 | 33402 | 38 | \$2.90 | 34010 | 46 | \$1.98 | 34440 | 45 | \$3.20 |
| 30205 | 66 | \$4.30 | 32218 | 53,84 | \$8.90 | 32688 | 101 | \$18.98 | 33403 | 38 | \$2.90 | 34012 | 46 | \$1.98 | 34442 | 45 | \$3.98 |
| 30210 | 66 | \$4.60 | 32221 | 53,84 | \$9.50 | 32689 | 101 | \$17.98 | 33404 | 38 | \$3.40 | 34014 | 46 | \$3.98 | 34444 | 45 | \$14.98 |
| 30215 | 66 | \$4.60 | 32224 | 53,84 | \$10.70 | 32690 | 101 | \$17.98 | 33405 | 38 | \$3.70 | 34016 | 46 | \$1.20 | 34490 | 45 | \$8.95 |
| 30217 | 66 | \$4.80 | 32227 | 53,84 | \$11.30 | 32691 | 101 | \$17.98 | 33406 | 38 | \$3.00 | 34018 | 46 | \$1.20 | 34712 | 50 | \$8.90 |
| 30220 | 66 | \$5.10 | 32230 | 53,84 | \$11.60 | 32692 | 101 | \$19.98 | 33407 | 38 | \$3.50 | 34020 | 46 | \$1.20 | 34715 | 50 | \$9.40 |
| 30223 | 66 | \$6.70 | 32233 | 53,84 | \$11.90 | 32694 | 101 | \$18.98 | 33408 | 38 | \$3.80 | 34022 | 46 | \$1.20 | 34718 | 50 | \$10.20 |
| 30225 | 66 | \$6.90 | 32236 | 53,84 | \$12.20 | 32695 | 101 | \$18.98 | 33409 | 38 | \$3.70 | 34024 | 46 | \$4.40 | 34721 | 50 | \$10.60 |
| 30227 | 66 | \$9.10 | 32243 | 53,84 | \$6.80 | 32696 | 101 | \$19.98 | 33410 | 38 | \$4.20 | 34026 | 46 | \$4.40 | 34724 | 50 | \$12.00 |
| 30230 | 66 | \$9.10 | 32246 | 53,84 | \$6.80 | 32697 | 101 | \$21.98 | 33411 | 38 | \$4.10 | 34028 | 46 | \$2.98 | 34727 | 50 | \$13.00 |
| 30235 | 66 | \$10.20 | 32249 | 53 | \$6.80 | 32698 | 98 | \$55.48 | 33412 | 38 | \$7.60 | 34030 | 46 | \$2.90 | 34730 | 50 | \$13.50 |
| 30236 | 66 | \$14.00 | 32252 | 53,84 | \$7.70 | 32702 | 104 | \$39.98 | 33413 | 38 | \$13.40 | 34034 | 46 | \$3.98 | 34733 | 50 | \$17.70 |
| 30238 | 66 | \$7.30 | 32255 | 53,84 | \$7.70 | 32703 | 104 | \$38.98 | 33414 | 38 | \$4.40 | 34036 | 46 | \$3.98 | 34753 | 50 | \$7.90 |
| 30239 | 66 | \$4.80 | 32258 | 53,84 | \$7.90 | 32704 | 104 | \$39.98 | 33416 | 38 | \$4.50 | 34038 | 46 | \$9.20 | 34759 | 50 | \$7.90 |
| 30240 | 68 | \$4.98 | 32261 | 53,84 | \$7.90 | 32705 | 104 | \$38.98 | 33417 | 38 | \$10.60 | 34040 | 46 | \$3.98 | 34765 | 50 | \$9.70 |
| 30242 | 68 | \$5.48 | 32264 | 53,84 | \$7.90 | 32706 | 105 | \$38.48 | 33418 | 37 | \$3.70 | 34042 | 46 | \$5.98 | 34771 | 50 | \$10.80 |
| 30244 | 68 | \$5.98 | 32267 | 53,84 | \$9.50 | 32708 | 105 | \$38.48 | 33420 | 37 | \$3.70 | 34044 | 46 | \$14.98 | 34774 | 50 | \$12.70 |
| 30246 | 68 | \$6.98 | 32270 | 53,84 | \$10.70 | 32710 | 105 | \$42.98 | 33421 | 38 | \$6.00 | 34046 | 46 | \$3.60 | 34777 | 50 | \$13.80 |
| 30248 | 68 | \$7.98 | 32273 | 53,84 | \$11.60 | 32711 | 105 | \$40.98 | 33422 | 37 | \$3.70 | 34048 | 46 | \$2.98 | 34791 | 50 | \$47.50 |
| 30255 | 66 | \$6.00 | 32276 | 53,84 | \$12.20 | 32712 | 105 | \$38.98 | 33423 | 38 | \$6.40 | 34090 | 46 | \$13.98 | 34792 | 50 | \$62.80 |
| 30265 | 66 | \$6.10 | 32278 | 53,84 | \$12.40 | 32714 | 106 | \$42.98 | 33424 | 37 | \$3.70 | 34120 | 49 | \$5.90 | 35001 | 54 | \$6.98 |
| 30292 | 68 | \$36.98 | 32280 | 53,84 | \$13.70 | 32716 | 106 | \$38.48 | 33425 | 38 | \$7.90 | 34121 | 49 | \$5.90 | 35002 | 54 | \$6.98 |
| 30294 | 66 | \$37.48 | 32291 | 53,84 | \$48.76 | 32718 | 106 | \$89.98 | 33426 | 37 | \$3.70 | 34122 | 49 | \$5.90 | 35003 | 54 | \$6.98 |
| 30295 | 66 | \$26.98 | 32292 | 53,84 | \$48.66 | 32720 | 106 | \$38.48 | 33427 | 38 | \$8.50 | 34123 | 49 | \$5.90 | 35004 | 54 | \$6.98 |
| 30297 | 66 | \$73.98 | 32293 | 53,84 | \$66.98 | 32721 | 106 | \$39.98 | 33428 | 37 | \$3.80 | 34124 | 49 | \$5.90 | 35005 | 54 | \$6.98 |
| 30298 | 66 | \$49.48 | 32294 | 53,84 | \$69.98 | 32722 | 107 | \$44.48 | 33430 | 37 | \$4.40 | 34125 | 49 | \$6.00 | 35006 | 54 | \$6.98 |
| 30299 | 66 | \$99.98 | 32505 | 85 | \$4.80 | 32724 | 107 | \$48.98 | 33432 | 37 | \$5.00 | 34126 | 49 | \$6.10 | 35007 | 54 | \$6.98 |
| 30815 | 65 | \$8.60 | 32511 | 85 | \$4.80 | 32726 | 107 | \$45.98 | 33433 | 37 | \$5.70 | 34127 | 49 | \$7.00 | 35008 | 54 | \$6.98 |
| 30817 | 65 | \$9.30 | 32516 | 85 | \$4.80 | 32728 | 107 | \$42.98 | 33434 | 38 | \$10.60 | 34128 | 49 | \$7.30 | 35009 | 54 | \$7.98 |
| 30820 | 65 | \$9.30 | 32521 | 85 | \$4.80 | 32732 | 108 | \$43.48 | 33435 | 38 | \$6.90 | 34129 | 49 | \$7.50 | 35010 | 54 | \$7.98 |
| 30825 | 65 | \$10.20 | 32526 | 85 | \$4.80 | 32734 | 108 | \$43.98 | 33436 | 38 | \$4.00 | 34130 | 49 | \$8.90 | 35011 | 54 | \$7.98 |
| 30830 | 65 | \$14.60 | 32531 | 85 | \$4.80 | 32742 | 108 | \$34.98 | 33437 | 38 | \$4.10 | 34131 | 49 | \$9.50 | 35012 | 54 | \$7.98 |
| 30835 | 65 | \$18.10 | 32536 | 85 | \$5.90 | 32744 | 108 | \$35.98 | 33438 | 38 | \$7.60 | 34134 | 49 | \$5.90 | 35013 | 54 | \$8.98 |
| 30892 | 65 | \$41.80 | 32541 | 85 | \$5.90 | 32746 | 108 | \$39.98 | 33439 | 37 | \$7.20 | 34135 | 49 | \$5.90 | 35014 | 54 | \$9.98 |
| 30898 | 65 | \$80.98 | 32546 | 85 | \$5.90 | 32748 | 109 | \$39.98 | 33440 | 37 | \$10.00 | 34136 | 49 | \$5.90 | 35015 | 54 | \$10.98 |
| 31105 | 66 | \$3.60 | 32551 | 85 | \$7.60 | 32750 | 109 | \$34.98 | 33442 | 37 | \$3.70 | 34137 | 49 | \$5.90 | 35016 | 54 | \$10.98 |
| 31110 | 66 | \$4.90 | 32556 | 85 | \$7.60 | 32752 | 109 | \$34.98 | 33444 | 37 | \$3.70 | 34138 | 49 | \$5.90 | 35017 | 54 | \$11.98 |
| 31112 | 66 | \$6.60 | 32561 | 85 | \$10.70 | 32790 | 109 | \$169.98 | 33446 | 37 | \$3.70 | 34139 | 49 | \$5.90 | 35018 | 54 | \$12.98 |
| 31114 | 66 | \$9.60 | 32566 | 85 | \$11.20 | 32791 | 109 | \$229.98 | 33448 | 37 | \$4.50 | 34140 | 49 | \$6.00 | 35019 | 54 | \$13.98 |
| 31115 | 66 | \$6.60 | 32590 | 85 | \$32.12 | 32804 | 90 | \$39.98 | 33450 | 37 | \$5.40 | 34141 | 49 | \$6.10 | 35020 | 54 | \$14.98 |
| 31117 | 66 | \$7.10 | 32601 | 98 | \$99.98 | 32806 | 90 | \$31.98 | 33452 | 37 | \$5.80 | 34142 | 49 | \$7.00 | 35021 | 54 | \$15.98 |
| 31118 | 66 | \$8.00 | 32603 | 96 | \$15.98 | 32807 | 90 | \$32.98 | 33453 | 38 | \$2.90 | 34143 | 49 | \$7.50 | 35022 | 54 | \$16.98 |
| 31120 | 66 | \$9.10 | 32606 | 96 | \$16.98 | 32808 | 90 | \$34.98 | 33454 | 37 | \$8.30 | 34144 | 49 | \$8.90 | 35023 | 54 | \$17.98 |
| 31125 | 66 | \$14.30 | 32609 | 96 | \$18.98 | 32810 | 91 | \$29.98 | 33456 | 38 | \$2.90 | 34145 | 49 | \$9.90 | 35024 | 54 | \$20.98 |
| 31135 | 66 | \$4.30 | 32612 | 96 | \$21.98 | 32814 | 88 | \$28.98 | 33458 | 37 | \$11.10 | 34193 | 49 | \$43.80 | 35025 | 54 | \$21.98 |
| 31140 | 66 | \$4.80 | 32615 | 96 | \$24.98 | 32816 | 88 | \$34.98 | 33459 | 38 | \$2.90 | 34194 | 49 | \$42.80 | 35026 | 54 | \$22.98 |
| 31150 | 68 | \$5.68 | 32618 | 97 | \$18.98 | 32818 | 88 | \$38.98 | 33462 | 38 | \$2.90 | 34302 | 51 | \$5.98 | 35027 | 54 | \$35.98 |
| 31151 | 68 | \$5.98 | 32621 | 97 | \$24.98 | 32820 | 88 | \$39.98 | 33465 | 38 | \$3.00 | 34304 | 51 | \$5.98 | 35028 | 54 | \$48.98 |
| 31152 | 68 | \$6.98 | 32623 | 97 | \$21.98 | 32830 | 89 | \$28.98 | 33468 | 38 | \$3.40 | 34306 | 51 | \$5.98 | 35029 | 54 | \$88.98 |
| 31168 | 63 | \$9.98 | 32625 | 97 | \$27.98 | 32832 | 89 | \$35.98 | 33471 | 38 | \$3.90 | 34308 | 51 | \$6.98 | 35032 | 54 | \$6.98 |
| 31169 | 63 | \$10.98 | 32630 | 97 | \$19.98 | 32834 | 89 | \$39.98 | 33474 | 38 | \$4.40 | 34310 | 51 | \$6.98 | 35033 | 54 | \$6.98 |
| 31199 | 63 | \$19.98 | 32633 | 97 | \$18.98 | 32835 | 89 | \$36.98 | 33477 | 38 | \$5.50 | 34312 | 51 | \$7.98 | 35034 | 54 | \$6.98 |
| 31201 | 65 | \$6.70 | 32638 | 99 | \$18.98 | 32836 | 89 | \$45.98 | 33480 | 38 | \$7.70 | 34314 | 51 | \$8.98 | 35035 | 54 | \$6.98 |
| 31202 | 65 | \$9.10 | 32639 | 99 | \$21.98 | 32838 | 89 | \$48.98 | 33492 | 38 | \$39.28 | 34336 | 51 | \$5.98 | 35036 | 54 | \$7.98 |
| 31203 | 65 | \$12.80 | 32641 | 99 | \$30.98 | 32846 | 89 | \$59.98 | 33493 | 38 | \$34.68 | 34338 | 51 | \$5.98 | 35037 | 54 | \$8.98 |
| 31305 | 67 | \$4.70 | 32642 | 99 | \$19.98 | 32848 | 89 | \$49.98 | 33494 | 37 | \$54.78 | 34339 | 51 | \$6.98 | 35038 | 54 | \$9.98 |
| 31310 | 67 | \$5.60 | 32643 | 99 | \$49.98 | 32860 | 91 | \$38.98 | 33496 | 37 | \$46.20 | 34340 | 51 | \$6.98 | 35039 | 54 | \$9.98 |
| 31312 | 67 | \$7.30 | 32645 | 96 | \$21.98 | 32870 | 91 | \$30.98 | 33498 | 37 | \$43.60 | 34341 | 51 | \$6.98 | 35040 | 54 | \$10.98 |
| 31315 | 67 | \$7.30 | 32646 | 99 | \$23.98 | 32891 | 86 | \$277.00 | 33603 | 52 | \$6.70 | 34342 | 51 | \$7.98 | 35041 | 54 | \$11.98 |
| 31320 | 67 | \$10.90 | 32649 | 99 | \$25.98 | 32892 | 86 | \$185.98 | 33606 | 52 | \$6.70 | 34343 | 51 | \$8.98 | 35042 | 54 | \$11.98 |
| 32005 | 82 | \$4.30 | 32650 | 85,154 | \$11.98 | 32893 | discontinued | | 33607 | 52 | \$13.40 | 34390 | 51 | \$49.78 | 35043 | 54 | \$12.98 |
| 32010 | 82 | \$4.30 | 32652 | 99 | \$28.98 | 32894 | 86 | \$214.98 | 33609 | 52 | \$6.80 | 34391 | 51 | \$48.78 | 35044 | 54 | \$13.98 |
| 32012 | 82 | \$4.30 | 32657 | 99 | \$16.98 | 32895 | 86 | \$278.98 | 33612 | 52 | \$7.10 | 34402 | 45 | \$4.84 | 35045 | 54 | \$14.98 |
| 32015 | 82 | \$4.60 | 32658 | 99 | \$18.98 | 32896 | 85 | \$48 | | | | | | | | | |



Numerical Index by Item Number

| Item No. | Page | Each | Item No. | Page | Each | Item No. | Page | Each | Item No. | Page | Each | Item No. | Page | Each | Item No. | Page | Each |
|----------|------|----------|----------|------|---------|----------|-------|---------|----------|------|---------|----------|------|---------|----------|--------|---------|
| 35056 | 54 | \$92.98 | 35240 | 42 | \$ 8.88 | 36115 | 25 | \$2.24 | 36328 | 23 | \$2.30 | 36609 | 25 | \$2.34 | 36961 | 35 | \$3.20 |
| 35090 | 55 | \$114.98 | 35241 | 42 | \$ 9.92 | 36120 | 25 | \$2.24 | 36329 | 23 | \$2.30 | 36610 | 25 | \$2.34 | 36962 | 35 | \$1.34 |
| 35091 | 55 | \$144.98 | 35242 | 42 | \$2.04 | 36125 | 25 | \$2.24 | 36330 | 22 | \$2.34 | 36615 | 25 | \$2.34 | 36963 | 35 | \$4.34 |
| 35092 | 55 | \$299.98 | 35243 | 42 | \$ 7.76 | 36127 | 25 | \$2.24 | 36332 | 23 | \$2.30 | 36620 | 25 | \$2.34 | 36965 | 35 | \$1.54 |
| 35093 | 55 | \$417.98 | 35244 | 42 | \$2.96 | 36130 | 25 | \$3.10 | 36335 | 23 | \$2.30 | 36625 | 25 | \$2.34 | 36968 | 35 | \$2.44 |
| 35094 | 55 | \$111.98 | 35245 | 42 | \$6.84 | 36140 | 25 | \$4.38 | 36337 | 23 | \$2.60 | 36627 | 25 | \$2.34 | 36971 | 35 | \$3.42 |
| 35095 | 55 | \$206.98 | 35246 | 42 | \$9.10 | 36197 | 25 | \$16.98 | 36339 | 23 | \$3.10 | 36630 | 25 | \$3.16 | 36990 | 34 | \$11.98 |
| 35096 | 55 | \$56.98 | 35247 | 42 | \$10.90 | 36199 | 25 | \$23.98 | 36340 | 22 | \$3.34 | 36640 | 25 | \$4.48 | 36991 | 35 | \$14.48 |
| 35097 | 55 | \$73.98 | 35248 | 42 | \$20.58 | 36204 | 16,68 | \$5.98 | 36342 | 23 | \$3.80 | 36645 | 23 | \$2.80 | 36992 | 34 | \$6.28 |
| 35098 | 55 | \$33.98 | 35249 | 42 | \$43.86 | 36205 | 16 | \$5.30 | 36345 | 22 | \$4.26 | 36646 | 23 | \$2.60 | 36993 | 35 | \$10.48 |
| 35099 | 55 | \$48.98 | 35250 | 42 | \$1.02 | 36206 | 16,68 | \$5.98 | 36346 | 23 | \$5.66 | 36647 | 23 | \$2.10 | 36996 | 40 | \$18.96 |
| 35104 | 43 | \$ 2.27 | 35251 | 42 | \$ 7.76 | 36208 | 16,68 | \$5.98 | 36350 | 22 | \$4.66 | 36648 | 23 | \$2.20 | 36997 | 40 | \$18.96 |
| 35108 | 43 | \$ 2.27 | 35252 | 42 | \$ 9.96 | 36209 | 16,68 | \$5.98 | 36352 | 23 | \$6.34 | 36649 | 23 | \$2.30 | 36998 | 35 | \$23.98 |
| 35112 | 43 | \$ 3.30 | 35253 | 42 | \$1.16 | 36210 | 16 | \$4.00 | 36355 | 22 | \$6.10 | 36650 | 23 | \$2.30 | 37013 | 22 | \$2.90 |
| 35116 | 43 | \$ 3.34 | 35254 | 42 | \$1.26 | 36211 | 24 | \$3.80 | 36357 | 23 | \$9.64 | 36651 | 23 | \$2.30 | 37016 | 22 | \$2.90 |
| 35120 | 43 | \$ 3.37 | 35255 | 42 | \$2.10 | 36212 | 16 | \$3.80 | 36360 | 22 | \$7.50 | 36652 | 23 | \$2.30 | 37019 | 22 | \$2.90 |
| 35124 | 43 | \$ 5.51 | 35256 | 42 | \$3.06 | 36215 | 16 | \$3.90 | 36390 | 22 | \$43.88 | 36653 | 23 | \$2.30 | 37022 | 22 | \$2.90 |
| 35128 | 43 | \$ 6.62 | 35257 | 42 | \$6.92 | 36218 | 16,68 | \$5.98 | 36392 | 22 | \$13.38 | 36654 | 23 | \$2.30 | 37026 | 22 | \$2.90 |
| 35132 | 43 | \$ 8.80 | 35258 | 42 | \$9.16 | 36219 | 16,68 | \$5.98 | 36393 | 23 | \$23.20 | 36655 | 23 | \$3.10 | 37029 | 22 | \$2.90 |
| 35136 | 43 | \$1.08 | 35259 | 42 | \$10.98 | 36220 | 16 | \$4.40 | 36394 | 22 | \$18.60 | 36659 | 23 | \$3.80 | 37032 | 22 | \$2.90 |
| 35140 | 43 | \$1.48 | 35260 | 42 | \$1.24 | 36223 | 24 | \$3.60 | 36395 | 21 | \$19.28 | 36661 | 23 | \$4.60 | 37036 | 22 | \$2.90 |
| 35143 | 43 | \$ 2.27 | 35261 | 42 | \$20.76 | 36224 | 16,68 | \$5.98 | 36396 | 21 | \$13.24 | 36690 | 25 | \$17.98 | 37090 | 22 | \$22.48 |
| 35144 | 43 | \$1.66 | 35270 | 42 | \$1.76 | 36225 | 16 | \$4.50 | 36397 | 21 | \$23.40 | 36691 | 25 | \$25.48 | 38001 | 149 | \$18.34 |
| 35145 | 43 | \$2.52 | 35280 | 42 | \$2.42 | 36228 | 24 | \$3.70 | 36398 | 21 | \$16.38 | 36699 | 23 | \$34.98 | 38002 | 149 | \$18.34 |
| 35146 | 43 | \$ 2.27 | 35282 | 42 | \$3.10 | 36229 | 24 | \$4.20 | 36409 | 21 | \$4.50 | 36710 | 39 | \$3.30 | 38003 | 149 | \$19.68 |
| 35147 | 43 | \$ 3.30 | 35284 | 42 | \$5.20 | 36230 | 16 | \$4.70 | 36410 | 21 | \$4.70 | 36713 | 39 | \$3.20 | 38004 | 149 | \$18.68 |
| 35150 | 43 | \$ 3.34 | 35285 | 42 | \$5.48 | 36233 | 24 | \$4.30 | 36415 | 21 | \$5.40 | 36715 | 39 | \$3.30 | 38006 | 149 | \$16.80 |
| 35152 | 43 | \$ 3.37 | 35286 | 42 | \$12.54 | 36235 | 16 | \$4.90 | 36417 | 21 | \$5.40 | 36716 | 39 | \$3.10 | 38007 | 149 | \$17.80 |
| 35153 | 43 | \$ 3.37 | 35288 | 42 | \$17.36 | 36238 | 24 | \$4.50 | 36420 | 21 | \$6.10 | 36719 | 39 | \$3.10 | 38008 | 149 | \$19.36 |
| 35155 | 43 | \$ 4.41 | 35290 | 42 | \$12.98 | 36239 | 24 | \$4.70 | 36422 | 21 | \$6.10 | 36720 | 39 | \$3.30 | 38009 | 149 | \$22.98 |
| 35156 | 43 | \$ 4.44 | 35291 | 42 | \$14.48 | 36240 | 16 | \$5.60 | 36425 | 21 | \$6.40 | 36723 | 39 | \$3.20 | 38010 | 149 | \$22.98 |
| 35159 | 43 | \$ 5.58 | 35295 | 42 | \$16.98 | 36243 | 24 | \$5.40 | 36427 | 21 | \$6.40 | 36725 | 39 | \$3.30 | 38015 | 154 | \$11.06 |
| 35162 | 43 | \$ 6.66 | 35297 | 42 | \$13.98 | 36245 | 16 | \$6.40 | 36430 | 21 | \$7.30 | 36726 | 39 | \$4.10 | 38025 | 85,154 | \$13.18 |
| 35165 | 43 | \$ 7.76 | 35301 | 43 | \$ 5.50 | 36248 | 24 | \$6.20 | 36432 | 21 | \$7.30 | 36728 | 39 | \$4.20 | 38030 | 53 | \$24.98 |
| 35168 | 43 | \$1.34 | 35302 | 43 | \$ 5.50 | 36250 | 16 | \$7.60 | 36435 | 21 | \$7.20 | 36730 | 39 | \$4.10 | 38033 | 53 | \$27.98 |
| 35171 | 43 | \$2.12 | 35303 | 43 | \$ 2.22 | 36253 | 24 | \$7.40 | 36437 | 21 | \$7.30 | 36732 | 39 | \$4.20 | 38450 | 67,154 | \$10.68 |
| 35174 | 43 | \$4.14 | 35304 | 43 | \$ 2.22 | 36255 | 24 | \$7.90 | 36440 | 21 | \$7.90 | 36734 | 39 | \$4.30 | 38460 | 67,154 | \$17.98 |
| 35175 | 43 | \$4.28 | 35305 | 43 | \$ 2.22 | 36264 | 15 | \$5.00 | 36442 | 21 | \$8.00 | 36736 | 39 | \$4.70 | 38490 | 67 | \$19.98 |
| 35176 | 43 | \$4.52 | 35306 | 43 | \$ 2.24 | 36266 | 15 | \$3.80 | 36445 | 21 | \$9.70 | 36738 | 39 | \$5.20 | 38800 | 52,154 | \$7.98 |
| 35177 | 43 | \$7.18 | 35307 | 43 | \$ 3.32 | 36268 | 15 | \$3.60 | 36452 | 21 | \$11.90 | 36740 | 39 | \$4.30 | 39425 | 74 | \$12.90 |
| 35178 | 43 | \$7.60 | 35308 | 43 | \$ 3.38 | 36269 | 15 | \$6.42 | 36455 | 21 | \$14.50 | 36742 | 39 | \$6.20 | 39430 | 74 | \$13.50 |
| 35179 | 43 | \$9.42 | 35309 | 43 | \$ 5.52 | 36270 | 15 | \$3.70 | 36460 | 21 | \$17.10 | 36744 | 39 | \$8.00 | 39440 | 74 | \$17.40 |
| 35180 | 43 | \$11.48 | 35310 | 43 | \$ 6.62 | 36271 | 15 | \$6.42 | 36461 | 24 | \$4.98 | 36750 | 39 | \$4.40 | 39450 | 74 | \$20.70 |
| 35191 | 43 | \$7.98 | 35311 | 43 | \$ 8.82 | 36272 | 15 | \$4.20 | 36463 | 24 | \$5.98 | 36760 | 39 | \$5.00 | 39460 | 74 | \$23.50 |
| 35192 | 43 | \$6.78 | 35312 | 43 | \$1.10 | 36273 | 15 | \$6.62 | 36466 | 24 | \$5.98 | 36780 | 39 | \$6.20 | 39500 | 74 | \$14.70 |
| 35193 | 43 | \$4.98 | 35313 | 43 | \$1.50 | 36274 | 15 | \$4.30 | 36469 | 24 | \$6.68 | 36786 | 39 | \$8.00 | 39501 | 74 | \$20.20 |
| 35194 | 43 | \$11.48 | 35314 | 43 | \$1.78 | 36275 | 15 | \$6.62 | 36472 | 24 | \$6.98 | 36790 | 40 | \$40.78 | 39502 | 74 | \$24.70 |
| 35201 | 42 | \$ 3.32 | 35316 | 43 | \$2.10 | 36276 | 15 | \$4.50 | 36474 | 24 | \$7.98 | 36791 | 39 | \$56.40 | 40001 | 59 | \$6.98 |
| 35202 | 42 | \$ 3.38 | 35317 | 43 | \$3.40 | 36277 | 15 | \$6.82 | 36476 | 24 | \$7.98 | 36792 | 40 | \$32.10 | 40002 | 59 | \$6.98 |
| 35204 | 42 | \$ 5.52 | 35318 | 43 | \$5.08 | 36278 | 15 | \$4.70 | 36478 | 24 | \$8.78 | 36793 | 39 | \$41.70 | 40003 | 59 | \$6.98 |
| 35205 | 42 | \$ 3.34 | 35319 | 43 | \$7.38 | 36279 | 15 | \$8.52 | 36480 | 20 | \$5.60 | 36794 | 39 | \$27.60 | 40004 | 59 | \$7.98 |
| 35206 | 42 | \$ 7.72 | 35320 | 43 | \$11.12 | 36280 | 15 | \$5.40 | 36481 | 20 | \$6.20 | 36795 | 40 | \$18.80 | 40005 | 59 | \$7.98 |
| 35208 | 42 | \$ 8.82 | 35321 | 43 | \$27.52 | 36281 | 15 | \$8.62 | 36482 | 20 | \$7.00 | 36904 | 34 | \$ 7.74 | 40006 | 59 | \$8.98 |
| 35210 | 42 | \$ 9.96 | 35330 | 43 | \$ 2.26 | 36282 | 15 | \$6.20 | 36483 | 20 | \$7.40 | 36908 | 34 | \$ 7.74 | 40007 | 59 | \$8.98 |
| 35211 | 42 | \$1.20 | 35331 | 43 | \$ 2.26 | 36283 | 15 | \$10.20 | 36484 | 20 | \$8.30 | 36912 | 34 | \$ 8.80 | 40008 | 59 | \$8.98 |
| 35212 | 42 | \$2.22 | 35332 | 43 | \$ 3.30 | 36284 | 15 | \$7.40 | 36486 | 20 | \$8.30 | 36916 | 34 | \$ 9.90 | 40009 | 59 | \$9.98 |
| 35214 | 42 | \$2.34 | 35333 | 43 | \$ 3.34 | 36285 | 15 | \$12.00 | 36487 | 20 | \$8.90 | 36920 | 34 | \$ 9.94 | 40010 | 75 | \$7.18 |
| 35215 | 42 | \$ 3.32 | 35334 | 43 | \$ 3.34 | 36286 | 15 | \$7.90 | 36490 | 21 | \$59.98 | 36924 | 34 | \$12.22 | 40011 | 75 | \$10.98 |
| 35216 | 42 | \$ 3.34 | 35335 | 43 | \$ 4.42 | 36287 | 15 | \$13.00 | 36492 | 21 | \$41.92 | 36928 | 34 | \$1.64 | 40012 | 59 | \$11.98 |
| 35217 | 42 | \$3.62 | 35336 | 43 | \$ 4.42 | 36288 | 15 | \$8.40 | 36496 | 24 | \$41.58 | 36936 | 34 | \$2.60 | 40013 | 59 | \$11.98 |
| 35218 | 42 | \$ 4.40 | 35337 | 43 | \$ 4.46 | 36289 | 16,68 | \$33.98 | 36497 | 20 | \$50.98 | 36940 | 35 | \$1.24 | 40014 | 59 | \$12.98 |
| 35219 | 42 | \$5.95 | 35338 | 43 | \$ 5.58 | 36291 | 15 | \$23.98 | 36510 | 22 | \$3.10 | 36941 | 35 | \$1.26 | 40015 | 59 | \$13.98 |
| 35220 | 42 | \$ 4.40 | 35339 | 43 | \$ 7.74 | 36292 | 16 | \$40.20 | 36512 | 22 | \$3.10 | 36942 | 35 | \$1.26 | 40016 | 59 | \$13.98 |
| 35221 | 42 | \$8.68 | 35340 | 43 | \$ 7.78 | 36293 | 16 | \$25.60 | 36515 | 22 | \$3.10 | 36943 | 35 | \$1.28 | 40017 | 59 | \$15.98 |
| 35222 | 42 | \$ 4.46 | 35341 | 43 | \$1.36 | 36294 | 15 | \$39.98 | 36520 | 22 | \$3.10 | 36944 | 34 | \$3.80 | 40018 | 59 | \$17.98 |
| 35223 | 42 | \$13.14 | 35342 | 43 | \$2.16 | 36297 | 15 | \$40.90 | 36525 | 22 | \$3.10 | 36945 | 35 | \$ 7.74 | 40019 | 59 | \$18.98 |
| 35224 | 42 | \$ 9.90 | 35343 | 43 | \$4.50 | 36298 | 15 | \$49.98 | 36530 | 22 | \$3.10 | 36946 | 35 | \$ 7.74 | 40020 | 59 | \$19.98 |
| 35225 | 42 | \$ 4.48 | 35345 | 43 | \$4.98 | 36299 | 24 | \$37.90 | 36535 | 22 | \$3.10 | 36947 | 35 | \$ 7.74 | 40021 | 144 | \$14.20 |
| 35226 | 42 | \$ 8.86 | 35346 | 43 | \$7.26 | 36305 | 22 | \$1.66 | 36540 | 25 | \$3.30 | 36948 | 35 | \$1.58 | 40022 | 144 | \$13.70 |
| 35227 | 42 | \$17.54 | 35347 | 43 | \$11.80 | 36306 | 22 | \$1.66 | 36542 | 25 | \$3.30 | 36949 | 35 | \$1.62 | 40023 | 144 | \$14.20 |
| 35228 | 42 | \$ 7.76 | 35348 | 43 | \$29.70 | 36307 | 22 | \$1.66 | 36544 | 25 | \$3.30 | 36950 | 35 | \$ 7.78 | 40024 | 144 | \$13.50 |
| 35230 | 42 | \$ 6.68 | 35390 | 43 | \$8.98 | 36308 | 22 | \$1.66 | 36546 | 25 | \$3.30 | 36951 | 35 | \$1.64 | 40025 | 144 | \$15.00 |
| 35231 | 42</ | | | | | | | | | | | | | | | | |



Toll Free: (800) 494-6104

Click on page number to view product

Made in Germany

Numerical Index by Item Number NIC = Not in Catalog

| Item No. | Page | Each | Item No. | Page | Each | Item No. | Page | Each | Item No. | Page | Each | Item No. | Page | Each | Item No. | Page | Each |
|----------|------|----------|----------|------|---------|----------|--------------|---------|----------|------|----------|----------|------|----------|----------|---------|----------|
| 40035 | 59 | \$38.98 | 43223 | 145 | \$21.98 | 45504 | 18 | \$3.30 | 46702 | 41 | \$2.60 | 47540 | 61 | \$119.98 | 50043 | 56 | \$10.98 |
| 40036 | 59 | \$55.98 | 43224 | 145 | \$21.98 | 45505 | 17 | \$2.40 | 46704 | 41 | \$2.60 | 47541 | 61 | \$9.98 | 50044 | 56 | \$10.98 |
| 40037 | 59 | \$65.98 | 43225 | 145 | \$21.98 | 45506 | 17 | \$2.20 | 46706 | 41 | \$2.60 | 47590 | 61 | \$133.98 | 50045 | 56 | \$11.98 |
| 40038 | 59 | \$67.98 | 43226 | 145 | \$21.98 | 45507 | 18 | \$3.30 | 46708 | 41 | \$2.60 | 47591 | 61 | \$120.98 | 50046 | 56 | \$11.98 |
| 40039 | 59 | \$105.98 | 43227 | 146 | \$21.98 | 45508 | 18 | \$3.40 | 46710 | 41 | \$2.60 | 47600 | 137 | \$26.80 | 50047 | 56 | \$12.98 |
| 40040 | 59 | \$122.98 | 43228 | 146 | \$21.98 | 45509 | 18 | \$3.60 | 46712 | 41 | \$3.10 | 47715 | 138 | \$20.90 | 50048 | 56 | \$13.98 |
| 40043 | 57 | \$6.98 | 43229 | 146 | \$21.98 | 45510 | 18 | \$3.60 | 46714 | 41 | \$3.10 | 47716 | 138 | \$22.40 | 50050 | 56 | \$14.98 |
| 40044 | 57 | \$6.98 | 43230 | 146 | \$19.98 | 45511 | 17 | \$2.30 | 46715 | 41 | \$2.60 | 47982 | 138 | \$21.00 | 50051 | 56 | \$16.98 |
| 40045 | 57 | \$7.98 | 43231 | 146 | \$29.98 | 45512 | 18 | \$5.40 | 46716 | 41 | \$3.10 | 48050 | 143 | \$29.50 | 50052 | 56 | \$18.98 |
| 40046 | 57 | \$7.98 | 43232 | 146 | \$29.98 | 45515 | 18 | \$3.80 | 46718 | 41 | \$3.10 | 48051 | 143 | \$32.90 | 50054 | 56 | \$20.98 |
| 40047 | 57 | \$8.98 | 43233 | 146 | \$29.98 | 45516 | 17 | \$2.60 | 46720 | 41 | \$2.60 | 48075 | 143 | \$19.40 | 50055 | 56 | \$22.98 |
| 40048 | 57 | \$9.98 | 43234 | 146 | \$29.98 | 45518 | 18 | \$5.50 | 46722 | 41 | \$4.10 | 48100 | 142 | \$17.20 | 50056 | 56 | \$25.98 |
| 40049 | 57 | \$11.98 | 43235 | 146 | \$29.98 | 45520 | 18 | \$4.00 | 46724 | 41 | \$4.10 | 48106 | 76 | \$11.98 | 50057 | 56 | \$26.98 |
| 40050 | 57 | \$11.98 | 43236 | 146 | \$29.98 | 45521 | 17 | \$2.60 | 46725 | 41 | \$2.60 | 48150 | 135 | \$13.70 | 50058 | 56 | \$33.98 |
| 40051 | 57 | \$12.98 | 43251 | 145 | \$29.98 | 45522 | 17 | \$4.30 | 46726 | 41 | \$5.10 | 48190 | 77 | \$36.98 | 50059 | 56 | \$36.98 |
| 40052 | 57 | \$14.98 | 43252 | 145 | \$29.98 | 45525 | 18 | \$4.30 | 46728 | 41 | \$6.70 | 48307 | 138 | \$69.90 | 50087 | 56 | \$237.98 |
| 40053 | 57 | \$16.98 | 43253 | 145 | \$29.98 | 45526 | 17 | \$2.70 | 46730 | 41 | \$3.10 | 48400 | 17 | \$6.28 | 50088 | 56 | \$167.98 |
| 40054 | 57 | \$17.98 | 43270 | 142 | \$23.70 | 45527 | 18 | \$4.80 | 46740 | 41 | \$3.10 | 48401 | 154 | \$7.98 | 50089 | 56 | \$293.98 |
| 40055 | 57 | \$18.98 | 43271 | 142 | \$25.10 | 45528 | 17 | \$4.70 | 46750 | 41 | \$3.10 | 48495 | 17 | \$21.98 | 50091 | 56 | \$208.98 |
| 40056 | 57 | \$21.98 | 43272 | 143 | \$20.20 | 45530 | 18 | \$5.40 | 46760 | 41 | \$4.10 | 48700 | 135 | \$23.20 | 50094 | 56 | \$145.98 |
| 40057 | 57 | \$23.98 | 43273 | 143 | \$21.50 | 45531 | 17 | \$3.90 | 46780 | 41 | \$5.10 | 48980 | 135 | \$19.40 | 50095 | 56 | \$185.98 |
| 40058 | 57 | \$28.98 | 43274 | 143 | \$16.10 | 45536 | 17 | \$3.30 | 46786 | 41 | \$6.70 | 49150 | 139 | \$39.90 | 51020 | 75 | \$4.90 |
| 40059 | 57 | \$33.98 | 43275 | 143 | \$29.90 | 45540 | 18 | \$6.00 | 46793 | 41 | \$22.98 | 49153 | 140 | \$15.40 | 51025 | 75 | \$5.10 |
| 40060 | 57 | \$33.98 | 43413 | 141 | \$30.40 | 45541 | 17 | \$3.80 | 46796 | 41 | \$20.98 | 49154 | 140 | \$18.10 | 51030 | 75 | \$5.40 |
| 40061 | 57 | \$35.98 | 43414 | 141 | \$23.50 | 45545 | 18 | \$6.10 | 46797 | 41 | \$44.80 | 49155 | 140 | \$14.90 | 51035 | 75 | \$6.00 |
| 40062 | 57 | \$55.98 | 43416 | 141 | \$23.50 | 45546 | 17 | \$4.50 | 46799 | 41 | \$33.68 | 49156 | 140 | \$17.00 | 51040 | 75 | \$6.50 |
| 40063 | 57 | \$56.98 | 43417 | 142 | \$23.40 | 45550 | 18 | \$6.30 | 46803 | 71 | \$3.98 | 49157 | 142 | \$16.70 | 51055 | 75 | \$8.40 |
| 40064 | 57 | \$57.98 | 43418 | 142 | \$23.40 | 45551 | 17 | \$5.10 | 46806 | 71 | \$4.98 | 49158 | 142 | \$15.80 | 51065 | 75 | \$10.20 |
| 40065 | 57 | \$69.98 | 43419 | 142 | \$23.40 | 45556 | 17 | \$5.40 | 46812 | 71 | \$5.98 | 49159 | 140 | \$19.10 | 51080 | 75 | \$13.20 |
| 40066 | 57 | \$104.98 | 43731 | 137 | \$48.10 | 45561 | 17 | \$5.50 | 46815 | 71 | \$6.98 | 49160 | 140 | \$19.70 | 51090 | 75 | \$33.06 |
| 40067 | 57 | \$104.98 | 43779 | 137 | \$44.90 | 45590 | discontinued | | 46912 | 71 | \$3.98 | 49161 | 140 | \$24.90 | 51092 | 75 | \$28.98 |
| 40068 | 57 | \$130.98 | 43780 | 137 | \$55.50 | 45591 | 17 | \$16.98 | 46915 | 71 | \$4.98 | 49184 | 135 | \$12.10 | 51105 | 75 | \$5.80 |
| 40086 | 60 | \$81.98 | 43799 | 137 | \$37.50 | 45592 | 17 | \$25.98 | 46921 | 71 | \$5.58 | 49185 | 135 | \$13.70 | 51110 | 75 | \$6.80 |
| 40087 | 59 | \$188.98 | 43800 | 134 | \$21.50 | 45593 | 18 | \$17.98 | 46924 | 71 | \$5.98 | 49215 | 142 | \$25.90 | 51120 | 75 | \$9.10 |
| 40088 | 60 | \$130.00 | 43801 | 134 | \$18.70 | 45594 | discontinued | | 46933 | 71 | \$6.98 | 49220 | 142 | \$26.30 | 52005 | 69 | \$5.70 |
| 40089 | 57 | \$230.98 | 43802 | 134 | \$18.90 | 45595 | 18 | \$31.98 | 46950 | 134 | \$28.90 | 49284 | 135 | \$14.10 | 52010 | 69 | \$6.50 |
| 40090 | 144 | \$61.20 | 43948 | 137 | \$28.40 | 45596 | 18 | \$14.98 | 46970 | 134 | \$24.60 | 49368 | 135 | \$25.40 | 52020 | 69 | \$6.40 |
| 40091 | 57 | \$169.00 | 43949 | 137 | \$27.90 | 45597 | 18 | \$43.98 | 46971 | 134 | \$23.70 | 49375 | 135 | \$22.50 | 52025 | 69 | \$6.90 |
| 40092 | 59 | \$448.98 | 44149 | 137 | \$27.70 | 45598 | 18 | \$20.98 | 46972 | 134 | \$23.60 | 49376 | 135 | \$24.80 | 52035 | 69 | \$8.70 |
| 40093 | 58 | \$74.98 | 44159 | 137 | \$29.00 | 45802 | 143 | \$26.90 | 46987 | 135 | \$24.50 | 49377 | 135 | \$21.50 | 52040 | 69 | \$11.10 |
| 40094 | 60 | \$114.00 | 44501 | 131 | \$13.18 | 45803 | 143 | \$26.90 | 46991 | 71 | \$32.48 | 49378 | 135 | \$20.40 | 52050 | 154, 69 | \$12.50 |
| 40095 | 58 | \$153.00 | 44502 | 131 | \$17.40 | 45805 | 143 | \$26.90 | 47299 | 137 | \$27.20 | 49379 | 135 | \$20.80 | 52090 | 69 | \$37.60 |
| 40096 | 60 | \$169.98 | 44503 | 131 | \$16.88 | 45807 | 143 | \$32.50 | 47501 | 61 | \$9.98 | 49380 | 136 | \$21.80 | 52105 | 69 | \$6.30 |
| 40097 | 58 | \$259.98 | 44504 | 131 | \$15.82 | 46060 | 72 | \$3.30 | 47502 | 61 | \$9.98 | 49381 | 136 | \$20.60 | 52110 | 69 | \$7.40 |
| 40098 | 60 | \$231.98 | 44505 | 131 | \$16.60 | 46069 | 137 | \$43.80 | 47503 | 61 | \$9.98 | 49382 | 136 | \$20.70 | 52115 | 69 | \$8.50 |
| 40099 | 57 | \$899.98 | 44506 | 131 | \$16.88 | 46070 | 72 | \$3.30 | 47504 | 61 | \$10.98 | 49383 | 136 | \$20.70 | 52120 | 69 | \$9.60 |
| 40110 | 144 | \$5.30 | 44507 | 131 | \$16.88 | 46072 | 72 | \$3.80 | 47505 | 61 | \$11.98 | 49384 | 136 | \$15.00 | 52125 | 69 | \$11.70 |
| 40140 | 144 | \$29.98 | 44508 | 131 | \$17.40 | 46074 | 72 | \$3.80 | 47506 | 61 | \$12.98 | 49385 | 136 | \$16.40 | 52650 | 69 | \$13.98 |
| 40144 | 144 | \$29.98 | 44509 | 131 | \$17.40 | 46075 | 72 | \$3.50 | 47507 | 61 | \$13.98 | 49387 | 136 | \$20.50 | 52711 | 16 | \$5.50 |
| 40420 | 144 | \$29.98 | 44510 | 131 | \$21.80 | 46076 | 72 | \$4.20 | 47508 | 61 | \$15.98 | 49388 | 136 | \$21.90 | 52713 | 16 | \$5.60 |
| 40422 | 144 | \$18.98 | 44511 | 131 | \$17.50 | 46077 | 72 | \$4.50 | 47509 | 61 | \$17.98 | 49478 | 136 | \$31.20 | 52716 | 16 | \$5.90 |
| 40424 | 144 | \$18.98 | 44512 | 131 | \$17.50 | 46078 | 72 | \$3.90 | 47510 | 61 | \$20.98 | 49487 | 136 | \$25.90 | 52719 | 16 | \$6.20 |
| 40426 | 144 | \$29.98 | 44513 | 132 | \$17.50 | 46080 | 72 | \$4.40 | 47511 | 61 | \$24.98 | 49501 | 138 | \$68.40 | 52722 | 16 | \$7.10 |
| 40430 | 144 | \$29.98 | 44514 | 132 | \$17.50 | 46081 | 72 | \$4.90 | 47512 | 61 | \$25.98 | 49584 | 138 | \$20.60 | 52726 | 16 | \$8.20 |
| 42012 | 139 | \$13.60 | 44515 | 132 | \$17.50 | 46082 | 72 | \$5.10 | 47513 | 61 | \$31.98 | 49585 | 138 | \$19.70 | 52729 | 16 | \$9.80 |
| 42013 | 139 | \$16.20 | 44518 | 132 | \$17.50 | 46084 | 72 | \$4.30 | 47514 | 61 | \$31.98 | 49587 | 138 | \$21.30 | 52732 | 16 | \$10.70 |
| 42141 | 141 | \$20.10 | 44520 | 132 | \$17.30 | 46085 | 72 | \$5.20 | 47515 | 61 | \$33.98 | 49588 | 138 | \$22.40 | 52790 | 16 | \$34.80 |
| 42142 | 141 | \$21.60 | 44521 | 132 | \$21.20 | 46087 | 72 | \$6.40 | 47516 | 61 | \$58.98 | 49600 | 138 | \$21.50 | 53010 | 64 | \$8.60 |
| 42146 | 141 | \$20.10 | 44522 | 132 | \$21.20 | 46089 | 72 | \$6.70 | 47517 | 61 | \$117.98 | 49620 | 138 | \$29.50 | 53015 | 64 | \$9.10 |
| 42148 | 141 | \$20.10 | 44523 | 132 | \$16.20 | 46094 | 73 | \$23.70 | 47518 | 61 | \$11.98 | 49640 | 136 | \$24.50 | 53020 | 64 | \$11.10 |
| 42149 | 141 | \$20.10 | 44524 | 132 | \$18.90 | 46095 | 73 | \$20.40 | 47519 | 61 | \$11.98 | 49709 | 140 | \$21.70 | 53025 | 64 | \$12.10 |
| 42150 | 141 | \$20.10 | 44525 | 132 | \$26.10 | 46097 | 73 | \$37.68 | 47520 | 61 | \$12.98 | 49714 | 140 | \$19.00 | 53027 | 64 | \$16.80 |
| 42151 | 141 | \$20.10 | 44526 | 132 | \$21.40 | 46098 | 73 | \$17.30 | 47521 | 61 | \$13.98 | 49716 | 140 | \$20.20 | 53035 | 64 | \$17.20 |
| 42152 | 141 | \$20.80 | 44527 | 132 | \$22.10 | 46147 | 72 | \$3.30 | 47522 | 61 | \$13.98 | 49779 | 136 | \$20.80 | 53040 | 64 | \$18.20 |
| 42155 | 141 | \$20.10 | 44528 | 133 | \$20.90 | 46150 | 72 | \$3.70 | 47523 | 61 | \$13.98 | 49783 | 136 | \$20.80 | 53090 | 64 | \$59.68 |
| 43010 | 134 | \$13.60 | 44529 | 133 | \$23.10 | 46151 | 72 | \$4.60 | 47524 | 61 | \$14.98 | 49879 | 136 | \$26.00 | 53097 | 64 | \$91.68 |
| 43014 | 134 | \$18.40 | 44530 | 133 | \$18.90 | 46152 | 72 | \$5.20 | 47525 | 61 | \$16.98 | 50004 | 56 | \$10.98 | 53110 | 64 | \$9.10 |
| 43015 | 142 | \$14.30 | 44531 | 133 | \$17.40 | 46153 | 72 | \$5.00 | 47526 | 61 | \$16.98 | 50005 | 56 | \$10.98 | 53115 | 64 | \$11.10 |
| 43016 | 142 | \$15.50 | 44532 | 133 | \$22.10 | 46157 | 72 | \$5.30 | 47527 | 61 | \$16.98 | 50006 | 56 | \$11.98 | 53120 | 64 | \$15.10 |
| 43040 | 67 | \$10.98 | 44533 | 133 | \$21.40 | 46162 | 72 | \$3.90 | 47528 | 61 | \$19.98 | 50007 | 56 | \$11.98 | 53310 | 70 | \$8.80 |
| 43090 | 67 | \$13.98 | 44590 | 124 | \$99.98 | 46167 | 72 | \$6.40 | 47529 | 61</ | | | | | | | |



Numerical Index by Item Number NIC = Not in Catalog

| Item No. | Page | Each | Item No. | Page | Each | Item No. | Page | Each | Item No. | Page | Each | Item No. | Page | Each | Item No. | Page | Each |
|----------|--------------|---------|----------|------|---------|----------|---------|---------|----------|--------|---------|----------|--------|---------|--------------|------|---------|
| 54016 | 36 | \$4.70 | 70157 | 162 | \$3.78 | 71150 | 158 | \$19.50 | 71370 | 167 | \$3.98 | 71566 | 156 | \$2.40 | 71945 | 163 | \$1.84 |
| 54018 | 36 | \$5.00 | 70158 | 162 | \$3.78 | 71151 | 159 | \$1.52 | 71371 | 167 | \$3.98 | 71567 | 156 | \$2.40 | 71946 | 163 | \$3.08 |
| 54022 | 36 | \$6.20 | 70159 | 162 | \$4.18 | 71152 | 159 | \$1.52 | 71372 | 167 | \$3.98 | 71568 | 156 | \$2.40 | 71949 | 165 | \$5.80 |
| 54024 | 36 | \$8.10 | 70160 | 161 | \$1.62 | 71153 | 159 | \$1.52 | 71374 | 167 | \$3.98 | 71569 | 156 | \$2.40 | 71950 | 165 | \$5.80 |
| 54040 | 36 | \$3.10 | 70163 | 161 | \$1.62 | 71154 | 159 | \$2.02 | 71375 | 167 | \$4.98 | 71570 | 162 | \$10.18 | 71951 | 165 | \$5.80 |
| 54050 | 36 | \$3.90 | 70168 | 161 | \$1.82 | 71155 | 159 | \$3.46 | 71376 | 167 | \$3.98 | 71571 | 162 | \$6.60 | 71952 | 165 | \$5.80 |
| 54060 | 36 | \$4.70 | 70195 | 169 | \$48.98 | 71181 | 155 | \$3.90 | 71377 | 167 | \$4.98 | 71574 | 155 | \$6.20 | 71953 | 165 | \$5.80 |
| 54080 | 36 | \$6.20 | 70403 | 166 | \$3.04 | 71182 | 155 | \$3.90 | 71378 | 167 | \$3.98 | 71576 | 155 | \$6.20 | 71954 | 165 | \$13.98 |
| 54086 | 36 | \$8.10 | 70406 | 166 | \$3.04 | 71183 | 155 | \$3.90 | 71379 | 167 | \$4.98 | 71578 | 155 | \$6.20 | 71957 | 165 | \$5.12 |
| 54090 | 36 | \$26.70 | 70409 | 166 | \$3.04 | 71196 | 159,152 | \$13.70 | 71380 | 167 | \$3.98 | 71580 | 155 | \$6.20 | 71958 | 165 | \$5.12 |
| 54091 | 36 | \$32.40 | 70412 | 166 | \$3.04 | 71198 | 152 | \$6.60 | 71381 | 167 | \$4.98 | 71582 | 155 | \$6.20 | 71959 | 165 | \$5.12 |
| 61601 | 102 | \$6.98 | 70415 | 166 | \$3.04 | 71199 | 158 | \$36.90 | 71382 | 167 | \$3.98 | 71584 | 155 | \$6.20 | 71960 | 163 | \$1.84 |
| 61602 | 102 | \$9.98 | 70418 | 166 | \$3.04 | 71200 | 164 | \$6.00 | 71383 | 167 | \$4.98 | 71585 | 156 | \$2.40 | 71963 | 165 | \$3.66 |
| 61609 | 102 | \$17.98 | 70421 | 166 | \$3.04 | 71201 | 164 | \$6.00 | 71384 | 167 | \$3.98 | 71586 | 156 | \$2.40 | 71964 | 165 | \$3.66 |
| 61619 | 102 | \$17.98 | 70424 | 166 | \$3.04 | 71202 | 164 | \$6.00 | 71385 | 167 | \$4.98 | 71587 | 156 | \$2.40 | 71965 | 165 | \$3.66 |
| 61620 | 102 | \$18.98 | 70427 | 166 | \$3.04 | 71203 | 164 | \$6.00 | 71386 | 167 | \$3.98 | 71588 | 156 | \$2.40 | 71966 | 165 | \$3.66 |
| 61662 | 102 | \$9.98 | 70430 | 166 | \$3.04 | 71211 | 155 | \$4.06 | 71388 | 167 | \$5.98 | 71603 | 161 | call | 71970 | 163 | \$4.26 |
| 62990 | 120 | \$18.98 | 70433 | 166 | \$5.06 | 71212 | 155 | \$4.06 | 71390 | 167 | \$5.98 | 71604 | 161 | call | 71971 | 163 | \$4.26 |
| 62991 | discontinued | | 70436 | 166 | \$5.06 | 71213 | 155 | \$4.06 | 71391 | 169 | \$39.98 | 71605 | 161 | call | 71972 | 163 | \$4.26 |
| 62992 | 120 | \$19.98 | 70439 | 166 | \$5.06 | 71221 | 155 | \$3.90 | 71392 | 169 | \$36.98 | 71606 | 161 | \$1.50 | 71973 | 163 | \$4.26 |
| 62993 | 120 | \$35.98 | 70442 | 166 | \$5.06 | 71222 | 155 | \$3.90 | 71394 | 168 | \$26.90 | 71607 | 161 | \$1.50 | 71974 | 163 | \$4.26 |
| 62994 | 120 | \$29.98 | 70445 | 166 | \$5.06 | 71223 | 155 | \$3.90 | 71396 | 163 | \$7.18 | 71608 | 161 | \$1.50 | 71975 | 163 | \$4.26 |
| 62995 | 120 | \$52.70 | 70448 | 166 | \$5.06 | 71250 | 164 | \$1.54 | 71397 | 163 | \$7.18 | 71609 | 161 | \$1.22 | 71980 | 163 | \$4.26 |
| 66850 | 119 | \$6.80 | 70451 | 166 | \$5.06 | 71251 | 164 | \$1.54 | 71399 | 152 | \$30.50 | 71610 | 161 | \$1.22 | 71981 | 163 | \$4.26 |
| 66904 | 33 | \$1.08 | 70454 | 166 | \$5.06 | 71252 | 164 | \$1.54 | 71404 | 158 | \$2.40 | 71615 | 161 | \$1.22 | 71982 | 163 | \$4.26 |
| 66908 | 33 | \$1.08 | 70457 | 166 | \$5.06 | 71253 | 164 | \$1.54 | 71414 | 158 | \$2.40 | 71620 | 161 | \$1.22 | 71983 | 163 | \$4.26 |
| 66912 | 33 | \$1.08 | 70460 | 166 | \$5.06 | 71254 | 164 | \$2.04 | 71424 | 158 | \$2.40 | 71625 | 161 | \$1.22 | 71984 | 163 | \$4.26 |
| 66916 | 33 | \$2.60 | 70507 | 161 | \$3.46 | 71301 | 168 | \$3.98 | 71431 | 166 | \$4.36 | 71627 | 161 | \$1.22 | 71990 | 153 | \$66.98 |
| 66918 | 34 | \$1.08 | 70508 | 161 | \$3.46 | 71302 | 168 | \$3.98 | 71433 | 166 | \$4.98 | 71630 | 161 | \$1.50 | 71991 | 153 | \$69.98 |
| 66920 | 33 | \$2.66 | 70509 | 161 | \$3.46 | 71303 | 163 | \$1.08 | 71435 | 166 | \$6.60 | 71640 | 161 | \$1.50 | 71996 | 169 | \$39.98 |
| 66922 | 34 | \$1.40 | 70510 | 161 | \$3.46 | 71304 | 162 | \$2.80 | 71437 | 166 | \$8.86 | 71648 | 162 | call | 72540 | 162 | \$2.54 |
| 66924 | 33 | \$2.86 | 70515 | 161 | \$3.46 | 71305 | 168 | \$3.98 | 71439 | 166 | \$11.80 | 71650 | 162 | call | 72545 | 162 | \$2.54 |
| 66926 | 34 | \$1.50 | 70520 | 161 | \$3.46 | 71306 | 163 | \$1.08 | 71441 | 166 | \$14.98 | 71652 | 162 | call | 72550 | 162 | \$2.54 |
| 66928 | 33 | \$3.32 | 70525 | 161 | \$3.46 | 71307 | 162 | \$2.80 | 71490 | 166 | \$10.16 | 71654 | 162 | call | 72555 | 162 | \$4.50 |
| 66930 | 34 | \$2.04 | 70527 | 161 | \$3.46 | 71308 | 163 | \$1.08 | 71491 | 166 | \$13.98 | 71656 | 162 | call | 74003 | 157 | \$1.46 |
| 66936 | 33 | \$4.68 | 70530 | 161 | \$3.46 | 71309 | 163 | \$1.08 | 71493 | 166 | \$6.98 | 71657 | 162 | call | 74006 | 157 | \$1.46 |
| 66937 | 34 | \$3.36 | 70540 | 161 | \$3.46 | 71310 | 162 | \$2.80 | 71495 | 160 | \$1.20 | 71658 | 162 | call | 74009 | 157 | \$1.46 |
| 66938 | 34 | \$4.50 | 70545 | 161 | \$3.96 | 71311 | 162 | \$2.80 | 71506 | 160 | \$1.20 | 71660 | 162 | call | 74010 | 157 | \$1.46 |
| 66944 | 33 | \$6.02 | 70550 | 161 | \$3.96 | 71312 | 163 | \$1.08 | 71507 | 160 | \$1.20 | 71690 | 151 | \$23.98 | 74012 | 157 | \$1.46 |
| 66945 | 33 | \$1.08 | 70555 | 161 | \$3.96 | 71313 | 168 | \$3.98 | 71508 | 160 | \$1.20 | 71726 | NIC | \$3.60 | 74015 | 157 | \$1.46 |
| 66946 | 33 | \$1.08 | | | 71314 | 168 | \$3.98 | 71509 | 160 | \$1.20 | 71728 | NIC | \$3.60 | 74016 | discontinued | | |
| 66947 | 33 | \$1.08 | 71001 | 157 | \$8.00 | 71315 | 163 | \$1.08 | 71510 | 160 | \$9.98 | 71730 | NIC | \$3.60 | 74018 | 157 | \$1.46 |
| 66950 | 33 | \$1.08 | 71002 | 157 | \$8.00 | 71317 | 168 | \$3.98 | 71515 | 160 | \$9.98 | 71732 | NIC | \$3.60 | 74021 | 157 | \$2.68 |
| 66952 | 33 | \$1.08 | 71003 | 157 | \$8.00 | 71318 | 163 | \$1.08 | 71516 | 155 | \$5.70 | 71734 | NIC | \$3.60 | 74023 | 157 | \$3.24 |
| 66953 | 33 | \$2.66 | 71004 | 157 | \$8.00 | 71319 | 168 | \$3.98 | 71517 | 155 | \$5.70 | 71736 | NIC | \$3.60 | 74050 | 157 | \$8.12 |
| 66955 | 33 | \$2.66 | 71010 | 155 | \$4.80 | 71320 | 168 | \$5.98 | 71518 | 155 | \$5.70 | 71738 | NIC | \$3.60 | 74101 | 156 | \$3.50 |
| 66956 | 33 | \$2.66 | 71011 | 155 | \$4.80 | 71321 | 163 | \$2.34 | 71519 | 155 | \$5.70 | 71740 | NIC | \$3.60 | 74103 | 158 | \$8.86 |
| 66959 | 33 | \$2.66 | 71012 | 155 | \$4.80 | 71322 | 168 | \$5.98 | 71520 | 160 | \$9.98 | 71750 | NIC | \$3.60 | 74105 | 156 | \$3.50 |
| 66962 | 33 | \$2.86 | 71013 | 155 | \$4.80 | 71323 | 168 | \$4.98 | 71521 | 155 | \$5.70 | 71760 | NIC | \$3.60 | 74106 | 158 | \$1.52 |
| 66965 | 33 | \$3.06 | 71014 | 155 | \$4.80 | 71324 | 163 | \$2.34 | 71522 | 155 | \$5.70 | 71801 | 164 | \$6.88 | 74108 | 156 | \$3.50 |
| 66968 | 33 | \$4.68 | 71020 | 155 | \$4.60 | 71325 | 168 | \$4.98 | 71525 | 160 | \$9.98 | 71802 | 164 | \$6.88 | 74109 | 159 | \$1.84 |
| 66971 | 33 | \$6.00 | 71021 | 155 | \$4.60 | 71326 | 163 | \$1.08 | 71527 | 160 | \$9.98 | 71803 | 164 | \$6.88 | 74111 | 159 | \$2.10 |
| 66990 | 33 | \$26.26 | 71022 | 155 | \$4.60 | 71328 | 163 | \$1.08 | 71530 | 160 | \$9.98 | 71851 | 165 | \$1.52 | 74112 | 158 | \$8.86 |
| 66991 | 33 | \$32.98 | 71023 | 155 | \$4.60 | 71329 | 163 | \$1.08 | 71536 | 161 | \$1.48 | 71852 | 165 | \$1.52 | 74113 | 159 | \$2.20 |
| 66992 | 33 | \$53.98 | 71024 | 155 | \$4.60 | 71330 | 163 | \$1.08 | 71537 | 161 | \$1.48 | 71853 | 165 | \$1.52 | 74115 | 158 | \$1.52 |
| 66994 | 34 | \$16.58 | 71051 | 157 | \$2.28 | 71331 | 168 | \$4.98 | 71538 | 161 | \$1.48 | 71854 | 165 | \$2.52 | 74116 | 159 | \$2.30 |
| 66995 | 34 | \$7.54 | 71052 | 157 | \$2.28 | 71333 | 163 | \$1.08 | 71539 | 161 | \$1.48 | 71900 | 165 | \$2.14 | 74118 | 159 | \$1.84 |
| 70107 | 167 | \$4.98 | 71053 | 157 | \$2.28 | 71336 | 163 | \$1.08 | 71540 | 160 | \$1.20 | 71901 | 165 | \$2.14 | 74121 | 159 | \$2.10 |
| 70108 | 167 | \$4.98 | 71054 | 157 | \$2.28 | 71339 | 163 | \$1.08 | 71541 | 161 | \$1.48 | 71902 | 165 | \$2.14 | 74123 | 159 | \$2.20 |
| 70109 | 167 | \$4.98 | 71055 | 157 | \$2.84 | 71342 | 163 | \$1.08 | 71542 | 161 | \$1.48 | 71903 | 165 | \$2.14 | 74124 | 158 | \$8.86 |
| 70110 | 167 | \$4.98 | 71056 | 159 | \$4.06 | 71343 | 162 | \$2.80 | 71543 | 161 | \$1.48 | 71904 | 165 | \$2.14 | 74126 | 159 | \$2.30 |
| 70113 | 167 | \$4.98 | 71090 | 151 | \$23.48 | 71345 | 163 | \$1.08 | 71544 | 161 | \$1.48 | 71905 | 165 | \$2.14 | 74127 | 158 | \$1.52 |
| 70115 | 167 | \$4.98 | 71094 | 152 | \$57.98 | 71346 | 162 | \$2.80 | 71545 | 161 | \$1.48 | 71906 | 165 | \$2.14 | 74130 | 159 | \$1.84 |
| 70117 | 167 | \$4.98 | 71095 | 153 | \$58.94 | 71348 | 163 | \$1.08 | 71546 | 161 | \$1.48 | 71907 | 165 | \$2.14 | 74131 | 159 | \$2.10 |
| 70119 | 167 | \$4.98 | 71100 | 158 | \$4.88 | 71349 | 162 | \$2.80 | 71547 | 161 | \$1.48 | 71908 | 165 | \$2.14 | 74133 | 159 | \$2.20 |
| 70121 | 167 | \$4.98 | 71101 | 158 | \$4.88 | 71351 | 163 | \$1.08 | 71550 | 162 | \$3.04 | 71909 | 165 | \$2.14 | 74136 | 159 | \$2.30 |
| 70123 | 167 | \$4.98 | 71102 | 158 | \$4.40 | 71352 | 162 | \$2.80 | 71551 | 162 | \$3.04 | 71910 | 165 | \$2.14 | 74141 | 155 | \$5.50 |
| 70127 | 161 | \$1.82 | 71103 | 158 | \$4.88 | 71353 | 163 | \$2.34 | 71552 | 162 | \$3.04 | 71914 | 165 | \$1.56 | 74142 | 155 | \$5.50 |
| 70128 | 161 | \$1.82 | 71111 | 155 | \$4.06 | 71354 | 162 | \$2.80 | 71553 | 162 | \$3.04 | 71916 | 165 | \$1.56 | 74143 | 155 | \$5.50 |
| 70129 | 161 | \$1.82 | 71112 | 155 | \$4.06 | 71356 | 163 | \$2.34 | 71554 | 162 | \$3.04 | 71918 | 165 | \$1.56 | 74150 | 159 | \$3.52 |
| 70135 | 161 | \$1.62 | 71113 | 155 | \$4.06 | 71358 | 162 | \$2.80 | 71555 | 162 | \$2.52 | 71920 | 165 | \$1.56 | 74161 | 155 | \$5.20 |
| 70139 | 161 | \$1.62 | 71121 | 156 | \$1.98 | 71360 | 163 | \$2.62 | | | | | | | | | |



Made in Germany

Toll Free: (800) 494-6104

Click on page number to view product

Numerical Index by Item Number

| Item No. | Page | Each | Item No. | Page | Each | Item No. | Page | Each | Item No. | Page | Each | Item No. | Page | Each | Item No. | Page | Each |
|----------|------|---------|----------|--------------|---------|----------|--------------|----------|----------|------|----------|----------|------|----------|----------|------|------|
| 74242 | 155 | \$5.50 | 74602 | 161 | call | 75392 | discontinued | | 77140 | 168 | \$6.48 | 92091 | 111 | \$183.40 | | | |
| 74243 | 155 | \$5.50 | 74603 | 161 | call | 75393 | discontinued | | 77142 | 168 | \$6.48 | 92190 | 117 | \$199.98 | | | |
| 74301 | 162 | \$3.30 | 74604 | 161 | \$3.18 | 75394 | discontinued | | 77144 | 168 | \$6.48 | 95090 | 118 | \$18.98 | | | |
| 74303 | 157 | \$1.84 | 74608 | 161 | \$3.18 | 75395 | 128 | \$31.98 | 77146 | 168 | \$6.48 | 95190 | 118 | \$18.98 | | | |
| 74305 | 162 | \$3.30 | 74612 | 161 | \$3.18 | 75396 | 128 | \$31.98 | 77148 | 168 | \$6.48 | 95391 | 119 | \$23.98 | | | |
| 74306 | 157 | \$1.84 | 74616 | 161 | \$3.18 | 75703 | 128 | \$1.98 | 77152 | 168 | \$6.98 | 95392 | 119 | \$16.98 | | | |
| 74307 | 162 | \$3.30 | 74620 | 161 | \$3.18 | 75704 | 128 | \$1.98 | 77154 | 168 | \$6.98 | 95490 | 119 | \$28.98 | | | |
| 74309 | 157 | \$1.84 | 74624 | 161 | \$3.18 | 75705 | 128 | \$1.98 | 77156 | 168 | \$6.98 | 95790 | 120 | \$24.98 | | | |
| 74311 | 163 | \$2.96 | 74628 | 161 | \$3.18 | 75706 | 128 | \$1.98 | 77158 | 168 | \$6.98 | 95792 | 120 | \$28.98 | | | |
| 74312 | 163 | \$2.96 | 74632 | 161 | \$3.18 | 75707 | 128 | \$1.98 | 77160 | 168 | \$6.98 | 96015 | 121 | \$4.30 | | | |
| 74313 | 163 | \$2.96 | 74636 | 161 | \$3.18 | 75708 | 128 | \$1.98 | 77162 | 168 | \$6.98 | 96018 | 121 | \$4.20 | | | |
| 74314 | 163 | \$2.96 | 74690 | 151 | \$33.98 | 75709 | 128 | \$1.98 | 77164 | 168 | \$6.98 | 96020 | 121 | \$3.80 | | | |
| 74315 | 163 | \$2.96 | 74711 | 161 | \$3.34 | 75710 | 128 | \$1.98 | 77166 | 168 | \$6.98 | 96025 | 121 | \$3.80 | | | |
| 74316 | 163 | \$2.96 | 74714 | 161 | \$3.34 | 75715 | 128 | \$1.98 | 77168 | 168 | \$6.98 | 96030 | 121 | \$3.70 | | | |
| 74317 | 163 | \$2.96 | 74717 | 161 | \$3.34 | 75720 | 128 | \$1.98 | 77170 | 168 | \$6.98 | 96035 | 121 | \$4.10 | | | |
| 74318 | 163 | \$2.96 | 74721 | 161 | \$3.34 | 75727 | 128 | \$2.20 | 77172 | 168 | \$6.98 | 96040 | 121 | \$4.20 | | | |
| 74319 | 162 | \$3.30 | 74724 | 161 | \$3.34 | 75728 | 128 | \$2.20 | 77174 | 168 | \$6.98 | 96100 | 121 | \$4.40 | | | |
| 74325 | 163 | \$2.96 | 74728 | 161 | \$3.34 | 75729 | 128 | \$2.20 | 77176 | 168 | \$6.98 | 96105 | 121 | \$4.30 | | | |
| 74330 | 163 | \$2.96 | 74732 | 161 | \$3.34 | 75735 | 128 | \$2.20 | 77304 | 167 | \$5.08 | 96110 | 121 | \$4.20 | | | |
| 74340 | 163 | \$2.96 | 74736 | 161 | \$3.34 | 75739 | 128 | \$2.20 | 77305 | 167 | \$5.08 | 96307 | 121 | \$4.60 | | | |
| 74350 | 163 | \$2.96 | 74739 | 161 | \$3.34 | 75742 | 128 | \$2.20 | 77306 | 167 | \$5.08 | 96309 | 121 | \$4.50 | | | |
| 74360 | 163 | \$2.96 | 74742 | 161 | \$3.34 | 75791 | 129 | \$27.50 | 77307 | 167 | \$5.08 | 96313 | 121 | \$4.30 | | | |
| 74369 | 162 | \$3.30 | 74803 | 164 | \$1.00 | 75792 | 129 | \$27.50 | 77308 | 167 | \$5.08 | 96315 | 121 | \$4.00 | | | |
| 74371 | 162 | \$3.30 | 74806 | 164 | \$1.00 | 75793 | 128 | \$46.98 | 77310 | 167 | \$5.08 | 96316 | 121 | \$4.00 | | | |
| 74373 | 162 | \$3.30 | 74809 | 164 | \$1.00 | 75800 | 127 | \$4.40 | 77331 | 167 | \$8.16 | 96320 | 121 | \$3.80 | | | |
| 74375 | 162 | \$3.30 | 74890 | 164 | \$4.18 | 75801 | 127 | \$4.40 | 77333 | 167 | \$8.16 | 96323 | 121 | \$3.80 | | | |
| 74377 | 162 | \$3.30 | 74901 | 165 | \$3.56 | 75900 | 128 | \$5.10 | 77335 | 167 | \$8.16 | 96325 | 121 | \$3.80 | | | |
| 74379 | 162 | \$3.30 | 74902 | 165 | \$3.56 | 75901 | 128 | \$6.10 | 77337 | 167 | \$8.16 | 96327 | 121 | \$3.60 | | | |
| 74380 | 163 | \$2.96 | 74903 | 165 | \$3.56 | 75991 | 129 | \$49.98 | 77341 | 167 | \$10.94 | 96330 | 121 | \$3.50 | | | |
| 74397 | 151 | \$23.40 | 74904 | 165 | \$3.56 | 75992 | 129 | \$49.98 | 77343 | 167 | \$10.94 | 96331 | 121 | \$3.50 | | | |
| 74399 | 152 | \$29.54 | 74910 | 151 | \$17.98 | 75993 | 129 | \$49.98 | 77345 | 167 | \$10.94 | 96413 | 121 | \$4.50 | | | |
| 74411 | 160 | \$2.68 | 74911 | 165 | \$3.56 | 75994 | 129 | \$49.98 | 77347 | 167 | \$10.94 | 96415 | 121 | \$4.50 | | | |
| 74413 | 160 | \$2.68 | 74912 | 165 | \$3.56 | 75995 | 129 | \$79.98 | 77349 | 167 | \$10.94 | 96416 | 121 | \$4.40 | | | |
| 74415 | 160 | \$2.68 | 74913 | 165 | \$3.56 | 75996 | 129 | \$79.98 | 77353 | 167 | \$10.94 | 96419 | 121 | \$4.40 | | | |
| 74417 | 160 | \$2.68 | 74914 | 165 | \$3.56 | 75997 | 129 | \$45.36 | 77390 | 167 | \$179.98 | 96420 | 121 | \$4.40 | | | |
| 74419 | 160 | \$2.54 | 74915 | 165 | \$3.56 | 75998 | 129 | \$45.36 | 77391 | 169 | \$57.98 | 96423 | 121 | \$4.40 | | | |
| 74421 | 160 | \$2.54 | 74920 | 151 | \$19.98 | 75999 | 128 | \$46.98 | 78020 | 78 | \$5.20 | 96425 | 121 | \$4.40 | | | |
| 74423 | 160 | \$2.54 | 74930 | 151 | \$24.44 | 76107 | 167 | \$3.98 | 79243 | 150 | \$15.98 | 96427 | 121 | \$4.40 | | | |
| 74429 | 160 | \$2.54 | 74940 | 151 | \$31.98 | 76109 | 167 | \$3.98 | 79245 | 150 | \$17.98 | 96430 | 121 | \$4.50 | | | |
| 74431 | 160 | \$2.54 | 75008 | 127 | \$1.98 | 76111 | 167 | \$3.98 | 79246 | 150 | \$17.30 | 96431 | 121 | \$4.50 | | | |
| 74433 | 160 | \$2.54 | 75012 | 127 | \$1.98 | 76113 | 167 | \$3.98 | 79247 | 150 | \$24.98 | 96436 | 121 | \$4.60 | | | |
| 74435 | 160 | \$2.54 | 75015 | 127 | \$1.98 | 76117 | 167 | \$3.98 | 79248 | 150 | \$15.98 | 96439 | 121 | \$4.70 | | | |
| 74511 | 160 | \$2.56 | 75018 | 127 | \$1.98 | 76119 | 167 | \$3.98 | 79249 | 150 | \$15.98 | 96510 | 121 | \$4.70 | | | |
| 74512 | 160 | \$2.56 | 75020 | 127 | \$1.98 | 76121 | 167 | \$3.98 | 79250 | 150 | \$10.98 | 96515 | 121 | \$4.70 | | | |
| 74513 | 160 | \$2.56 | 75025 | 127 | \$1.98 | 76123 | 167 | \$3.98 | 79251 | 150 | \$11.98 | 96520 | 121 | \$4.90 | | | |
| 74517 | 160 | \$2.56 | 75030 | 127 | \$1.98 | 76129 | 167 | \$3.98 | 79256 | 150 | \$17.30 | 96523 | 121 | \$4.90 | | | |
| 74519 | 160 | \$2.56 | 75035 | 127 | \$1.98 | 76131 | 167 | \$3.98 | 79290 | 151 | \$4.10 | 96525 | 121 | \$4.90 | | | |
| 74521 | 160 | \$2.56 | 75040 | 127 | \$1.98 | 76191 | 169 | \$39.98 | 79443 | 148 | \$19.98 | 96527 | 121 | \$4.90 | | | |
| 74523 | 160 | \$2.56 | 75091 | discontinued | | 76312 | 167 | \$3.98 | 79445 | 148 | \$23.98 | 96530 | 121 | \$5.00 | | | |
| 74529 | 160 | \$2.56 | 75092 | discontinued | | 76314 | 167 | \$3.98 | 79446 | 148 | \$21.98 | 96531 | 121 | \$5.10 | | | |
| 74531 | 160 | \$2.56 | 75105 | 127 | \$1.98 | 76316 | 167 | \$3.98 | 79447 | 148 | \$29.98 | 96532 | 121 | \$5.10 | | | |
| 74533 | 160 | \$2.56 | 75110 | 127 | \$1.98 | 76318 | 167 | \$3.98 | 80025 | 47 | \$22.98 | 96535 | 121 | \$5.10 | | | |
| 74535 | 160 | \$2.56 | 75115 | 127 | \$1.98 | 76322 | 167 | \$3.98 | 80030 | 47 | \$22.98 | 96536 | 121 | \$5.10 | | | |
| 74536 | 160 | \$3.26 | 75120 | 127 | \$1.98 | 76324 | 167 | \$3.98 | 80035 | 47 | \$23.98 | 96539 | 121 | \$5.30 | | | |
| 74538 | 160 | \$3.26 | 75191 | discontinued | | 76326 | 167 | \$3.98 | 80040 | 47 | \$27.98 | 96540 | 121 | \$5.30 | | | |
| 74542 | 160 | \$3.26 | 75192 | discontinued | | 76328 | 167 | \$3.98 | 80045 | 47 | \$31.98 | 96545 | 121 | \$5.30 | | | |
| 74544 | 160 | \$3.26 | 75307 | 127 | \$1.98 | 76346 | 167 | \$5.98 | 80050 | 47 | \$35.98 | 96547 | 121 | \$5.30 | | | |
| 74546 | 160 | \$3.26 | 75309 | 127 | \$1.98 | 76348 | 167 | \$5.98 | 80060 | 47 | \$49.98 | 96550 | 121 | \$5.30 | | | |
| 74548 | 160 | \$3.26 | 75313 | 127 | \$1.98 | 76352 | 167 | \$5.98 | 80070 | 47 | \$60.98 | 96555 | 121 | \$5.50 | | | |
| 74551 | 160 | \$3.26 | 75315 | 127 | \$1.98 | 76354 | 167 | \$6.98 | 80200 | 47 | \$3.90 | 96556 | 121 | \$5.50 | | | |
| 74553 | 160 | \$3.26 | 75320 | 127 | \$1.98 | 76395 | 169 | \$32.98 | 80202 | 47 | \$4.00 | 96560 | 121 | \$5.50 | | | |
| 74556 | 160 | \$3.26 | 75322 | 127 | \$2.20 | 76396 | 169 | \$39.98 | 80204 | 47 | \$4.70 | 96563 | 121 | \$5.50 | | | |
| 74558 | 160 | \$3.26 | 75325 | 127 | \$1.98 | 77102 | 168 | \$6.48 | 80206 | 47 | \$5.30 | 96570 | 121 | \$5.60 | | | |
| 74561 | 160 | \$3.26 | 75327 | 127 | \$2.20 | 77104 | 168 | \$6.48 | 80208 | 47 | \$6.30 | 96705 | 121 | \$5.20 | | | |
| 74563 | 160 | \$3.86 | 75330 | 127 | \$1.98 | 77106 | 168 | \$6.48 | 80210 | 47 | \$7.20 | 96706 | 121 | \$5.20 | | | |
| 74565 | 160 | \$3.86 | 75332 | 127 | \$2.20 | 77108 | 168 | \$6.48 | 80213 | 47 | \$10.10 | 96707 | 121 | \$5.20 | | | |
| 74567 | 160 | \$3.86 | 75340 | 127 | \$1.98 | 77110 | 168 | \$6.48 | 80216 | 47 | \$11.10 | 96708 | 121 | \$5.20 | | | |
| 74569 | 160 | \$3.86 | 75342 | 127 | \$2.20 | 77112 | 168 | \$6.48 | 80219 | 47 | \$12.98 | 96709 | 121 | \$5.30 | | | |
| 74571 | 160 | \$3.86 | 75350 | 127 | \$1.98 | 77114 | 168 | \$6.48 | 80222 | 47 | \$18.98 | 96710 | 121 | \$5.50 | | | |
| 74573 | 160 | \$3.86 | 75352 | 127 | \$1.98 | 77116 | 168 | \$6.48 | 80225 | 47 | \$25.98 | 96715 | 121 | \$5.60 | | | |
| 74575 | 160 | \$3.86 | 75354 | 127 | \$1.98 | 77118 | 168 | \$6.48 | 80230 | 47 | \$25.98 | 96720 | 121 | \$5.70 | | | |
| 74577 | 160 | \$3.86 | 75356 | 127 | \$1.98 | 77120 | 168 | \$6.48 | 80235 | 47 | \$26.98 | 96800 | 119 | \$4.88 | | | |
| 74579 | 160 | \$3.86 | 75358 | 127 | \$1.98 | 77122 | 168 | \$6.48 | 80240 | 47 | \$30.98 | | | | | | |
| 74581 | 160 | \$3.86 | 75360 | 127 | \$1.98 | 77124 | 168 | \$6.48 | 80245 | 47 | \$34.98 | | | | | | |
| 74583 | 160 | \$3.86 | 75362 | 127 | \$2.20 | 77126 | 168 | \$6.48 | 80250 | 47 | \$38.98 | | | | | | |
| 74586 | 160 | \$6.12 | 75364 | 127 | \$2.20 | 77128 | 168 | \$6.48 | 80260 | 47 | \$52.98 | | | | | | |
| 74587 | 160 | \$6.12 | 75366 | 127 | \$2.20 | 77130 | 168 | \$6.48 | 80270 | 47 | \$63.98 | | | | | | |
| 74588 | 160 | \$6.12 | 75368 | 127 | \$2.20 | 77132 | 168 | \$6.48 | 80280 | 47 | \$149.98 | | | | | | |
| 74589 | 160 | \$6.12 | 75370 | 127 | \$2.20 | 77134 | 168 | \$6.48</ | | | | | | | | | |



Made in Germany

NEW! MagicSpring Screw Holding Torx Tools

- Laser welded assembly
- Holds screws securely
- Won't damage screws
- Doesn't weaken tool
- Exact fit tips
- Hardened tool steel blades
- Holds standard Torx screws*



Stainless Rotary Spring
Wiha Patented Design

Laser Welded MagicSpring Assembly

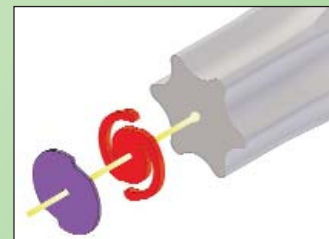

362 MagicSpring Screwholding TORX® Screwdriver, With Wiha-SoftFinish® Handle. Round blade high alloy chrome-vanadium-molybdenum steel, hardened, chrome-plated, Wiha-Chromtop finish on tips. Wiha-SoftFinish® handle, multi-component, cushion grips.

| Item No. | Size | mm | Inch | mm | Inch | mm | Inch | lbs. | Each |
|----------|------|-----|------|-----|------|-----|------|------|--------|
| 362 02 | T6 | 60 | 2.4 | 3.5 | .139 | 164 | 6.5 | .07 | \$5.48 |
| 362 03 | T7 | 60 | 2.4 | 3.5 | .139 | 164 | 6.5 | .07 | \$5.58 |
| 362 07 | T8 | 60 | 2.4 | 3.5 | .139 | 164 | 6.5 | .07 | \$5.78 |
| 362 34 | T9 | 60 | 2.4 | 4.0 | .157 | 171 | 6.7 | .11 | \$5.98 |
| 362 44 | T10 | 80 | 3.0 | 4.0 | .157 | 191 | 7.5 | .11 | \$6.18 |
| 362 49 | T15 | 80 | 3.0 | 4.0 | .157 | 191 | 7.5 | .11 | \$6.28 |
| 362 54 | T20 | 100 | 4.0 | 4.0 | .157 | 211 | 8.3 | .16 | \$6.48 |
| 362 56 | T25 | 100 | 4.0 | 4.5 | .177 | 211 | 8.3 | .17 | \$6.88 |
| 362 57 | T27 | 115 | 4.5 | 5.5 | .216 | 233 | 9.2 | .20 | \$7.58 |
| 362 58 | T30 | 115 | 4.5 | 6.0 | .236 | 233 | 9.2 | .21 | \$8.98 |



362 90 Set 6 Pcs. MagicSpring Screwholding TORX® SoftFinish Screwdrivers Round blade high alloy chrome-vanadium-molybdenum steel, hardened, chrome-plated. Wiha-Chromtop finish on tips. Wiha-SoftFinish® handle, multi-component, cushion grips. Molded on.

| Item No. | Size | mm | Size | mm | lbs. | | |
|----------|--------|-----|------|--------|------|-----|---------|
| 362 90 | 362 66 | T8 | 60 | 362 72 | T20 | 100 | .98 |
| | 362 68 | T10 | 80 | 362 74 | T25 | 100 | Each |
| | 362 70 | T15 | 80 | 362 76 | T30 | 115 | \$39.98 |



267 MagicSpring Screwholding TORX® Screwdriver, With Wiha-Precision Pico Finish Handle Blade high alloy CVM steel, hardened, chrome-plated. Molded on ergonomic Wiha-Pico Finish precision handle, molded on, soft grips.

| Item No. | Size | mm | Inch | mm | Inch | lbs. | Each |
|----------|------|----|------|-----|------|------|--------|
| 267 21 | T6 | 40 | 1.57 | 140 | 5.5 | .03 | \$6.98 |
| 267 23 | T7 | 40 | 1.57 | 140 | 5.5 | .03 | \$6.98 |
| 267 25 | T8 | 40 | 1.57 | 140 | 5.5 | .03 | \$6.98 |
| 267 27 | T9 | 50 | 1.97 | 150 | 5.9 | .04 | \$6.98 |
| 267 29 | T10 | 50 | 1.97 | 150 | 5.9 | .04 | \$6.98 |
| 267 31 | T15 | 60 | 2.36 | 160 | 6.3 | .04 | \$6.98 |



267 98 MagicSpring Screwholding TORX® Screwdriver, With Wiha-Precision Pico Finish Handle Blade high alloy CVM steel, hardened, chrome-plated. Molded on ergonomic Wiha-Pico Finish precision handle, molded on, soft grips.

| Item No. | Size | mm | Size | mm | lbs. | | |
|----------|--------|----|------|--------|------|----|---------|
| 267 98 | 267 21 | T6 | 40 | 267 27 | T9 | 50 | .45 |
| | 267 23 | T7 | 40 | 267 29 | T10 | 50 | Each |
| | 267 25 | T8 | 40 | 267 31 | T15 | 60 | \$40.98 |

* MagicSpring tools will hold Torx® screws made to CamCar Textron Torx® specifications



Made in Germany

NEW! MagicSpring Screw Holding Torx Tools

MagicSpring Screwholding TORX® L-keys



371 MagicSpring Screwholding TORX® L-key, Long Arm
High alloy chrome-vanadium-molybdenum steel, hardened, black finish.

| Item | Star | mm | Inch | mm | Inch | lbs. | Each |
|--------|------|-----|------|----|------|------|--------|
| 371 06 | T6 | 65 | 2.5 | 16 | .63 | .001 | \$3.40 |
| 371 07 | T7 | 71 | 2.8 | 18 | .71 | .002 | \$3.30 |
| 371 08 | T8 | 77 | 3.0 | 20 | .78 | .003 | \$3.30 |
| 371 09 | T9 | 83 | 3.2 | 22 | .86 | .005 | \$3.30 |
| 371 10 | T10 | 90 | 3.5 | 24 | .94 | .007 | \$3.30 |
| 371 15 | T15 | 97 | 3.8 | 26 | 1.0 | .009 | \$3.30 |
| 371 20 | T20 | 104 | 4.1 | 29 | 1.1 | .01 | \$3.50 |
| 371 25 | T25 | 112 | 4.4 | 33 | 1.3 | .02 | \$3.70 |
| 371 27 | T27 | 122 | 4.8 | 36 | 1.4 | .03 | \$4.80 |
| 371 30 | T30 | 132 | 5.2 | 40 | 1.6 | .04 | \$5.00 |
| 371 40 | T40 | 143 | 5.6 | 44 | 1.7 | .07 | \$6.40 |



371 90 MagicSpring Long Arm Screwholding TORX® Set, 7 Pc. in Plastic Holder Equipped with T6, T7, T8, T9, T10, T15, T20

| Item | lbs. | Each |
|--------|------|---------|
| 371 90 | .20 | \$23.60 |



371 92 MagicSpring Long Arm Screwholding TORX® Set, 10 Pc. in Plastic Holder Equipped with T6, T7, T8, T9, T10, T15, T20, T25, T27, T30

| Item | lbs. | Each |
|--------|------|---------|
| 371 92 | .35 | \$36.60 |

MagicSpring Screwholding TORX® Wing Tools



365 MagicSpring Screwholding TORX® driver, With Wing Handle
Ideal for use with indexable carbide tooling and also for working in confined spaces. Blade high alloy CVM steel, hardened, black finish. Wing handle high quality plastic, impact resistant. Molded on.

| Item | Star | mm | Inch | mm | Inch | mm | Inch | lbs. | Each |
|--------|------|----|------|----|------|----|------|------|--------|
| 365 56 | T6 | 35 | 1.4 | 70 | 2.7 | 40 | 1.6 | .01 | \$4.28 |
| 365 57 | T7 | 35 | 1.4 | 70 | 2.7 | 40 | 1.6 | .02 | \$4.38 |
| 365 58 | T8 | 40 | 1.6 | 75 | 2.9 | 40 | 1.6 | .02 | \$4.38 |
| 365 59 | T9 | 40 | 1.6 | 75 | 2.9 | 40 | 1.6 | .02 | \$4.38 |
| 365 60 | T10 | 40 | 1.6 | 75 | 2.9 | 40 | 1.6 | .02 | \$4.48 |
| 365 61 | T15 | 45 | 1.7 | 80 | 3.1 | 40 | 1.6 | .02 | \$4.48 |
| 365 62 | T20 | 50 | 2.0 | 80 | 3.1 | 40 | 1.6 | .02 | \$4.68 |



365 98 MagicSpring Screwholding TORX® Wing Handle Set, 7 Pc. in Metal Stand.

| Equipped with | lbs. | Each |
|-------------------------------|------|---------|
| T6, T7, T8, T9, T10, T15, T20 | .36 | \$37.98 |



ScrewHolding Torx Tools